

5000 Series Furniture

Prices effective December 7, 2009

Introduction	page 2
5000 Series Furniture	3
Work Surfaces	5
Storage	75
Display Components	98
Lighting	100
L-Style Products	105
Index	139

Appendices

To view and/or print price book appendices, select the appropriate price book from www.HermanMiller.com.

Introduction

A Note on the Organization of This Book

There are a few signals that will help you understand the organization of this book. Once you know them, you should be able to find your way around easily.

Like a newspaper, this book is formatted with columns of text and illustrations that run vertically.

Information wraps from one column to the next and continues for as many pages as it needs to.

Black bars are clues.

A black bar at the top of a page signals the start of information about a product.

This information is divided into two sections, each signaled by a black bar. Product Information includes a description, additional notes, and dimensional drawings. Specification Information, which always begins at the top of a column, includes a series of steps. Each step represents a decision you need to make in order to complete your product number. Steps must be followed sequentially. The number of pages needed to complete information on a product varies; some will be complete in one page; others may fill three or four pages. Just continue going through the steps until you run into the next product, signaled by the black bar at the top of the page.

Black tabs running along the outside edge of the page help you locate what section you are in or what section you want to go to. You can thumb forwards or backwards to find a section; tabs and text appear on both sides of the page.

The additional pages in the back of the book include the appendices and indices. They are signaled by a long black bar running along the outside edge of the page.

The index is presented two ways.

The first index is in alphabetical order by product name. It can be helpful if you are new to the products and numbering scheme or if you are looking for a type of product, such as work chair or round table.

The second index is by product number. It lists, in alphanumeric order, the base product number, typically a five-digit number.

General Information

This book is effective December 7, 2009, subject to change without notice. Products may be purchased from authorized Herman Miller dealers who will quote prices upon request. For more information about our products and services or to see a list of dealers, visit www.HermanMiller.com.

All prices are list prices. Additional services, such as planning services, design, storage, and installation, are not included and must be added to these prices when the additional services are requested.

Illustrations, specifications, and prices are based on the latest information at the time of publication. The right is reserved to make changes at any time without notice in prices, fabrics, finishes, materials, specifications, and models, and also to discontinue models and finishes.

Dimensions shown in the drawings are engineering drawing dimensions rounded up to the nearest $\frac{1}{8}$ ". Product is shipped set up or knocked down. Products that include "Shipped knocked down" in the description require some assembly. If this statement does not appear in the description, the product is shipped assembled.

Service problems are normally handled by a Herman Miller authorized dealer. Where this cannot be accomplished on a local level, service problems should be referred to the Customer Care Representative for your region, Herman Miller, Inc., Zeeland, Michigan 49464.

20-Day or Less/Assigned Lead-Time Shipments

All products and options in this price book not designated by an Assigned Program icon  will ship in **20 business days or less** after being acknowledged by Herman Miller.

Products and options designated by an  are on the assigned lead-time program and may ship in 20 days, less than 20 days, or more than 20 days from order acknowledgement.

Work Surfaces

Storage

Display Components

Lighting

L-Style Products

Desk Shell

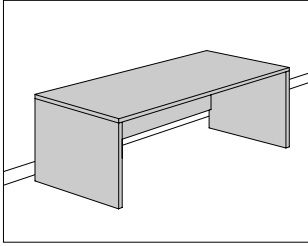

Product Information

Description

This desk shell connects to a 5000 Series desk component or stands alone. It has a laminate top and vinyl edge or a veneer top and edge and is available with or without grommets. The desk has full or 10"-deep recessed end panels and 1" adjustable glides. 20"- and 24"-deep desks with recessed end panels have a cable management cutout at the back of the panel. The desk is available with a full, raised, or open back panel. The full back panel extends to the floor; the raised back panel is 8 1/8" from the floor and provides access to electrical components in panel system raceways; the open back panel is used against architectural walls or panel systems and provides maximum access to electrical/data outlets, including those complying with ADA standards. The open back panel includes a horizontal support rail; the bottom of the support rail is 8 1/8" from the floor.

Notes

30"- and 36"-deep desks have back panel recessed 4 1/2" from visitor's side.

To use desk freestanding, order 2 full end panels. To connect desk to 5000 Series component, 1 recessed end panel may be required.

Order optional desk components separately:

- Bridge
- Return shell
- Return with single pedestal

To manage cables under desk shell, order cable management trough separately.

Order optional display or storage components separately:

- Desk-mounted tackboard
- Desk-mounted tool rail with tackboard
- End-mounted tackboard
- Flipper door unit

For accessory product applications, the following Compatibility Charts are available electronically for viewing and printing in Kiosk and HermanMiller.com: Keyboard Compatibility Charts, Pencil Drawer Compatibility Charts, and Work Organizer Compatibility Chart.

Dimensions

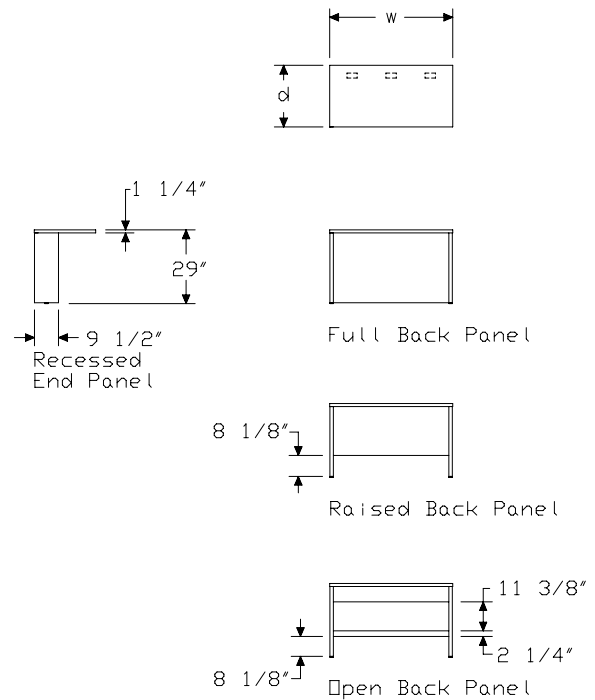

Specification Information

Step 1.		
5		

Step 2. Back Panel

F0-	full back panel	\$0
R0-	raised back panel	\$0
P0-	open back panel	\$0

Step 3. Width

48	48" wide	+\$0
60	60" wide	+\$0
66	66" wide	+\$0
72	72" wide	+\$0

Step 4. Depth

For 48" wide (48)

24-	24" deep	+\$934
30-	30" deep	+\$978
36-	36" deep	+\$1017

For 60" wide (60)

20-	20" deep	+\$803
24-	24" deep	+\$1019
30-	30" deep	+\$1070
36-	36" deep	+\$1124

For 66" wide (66)

20-	20" deep	+\$843
24-	24" deep	+\$1056
30-	30" deep	+\$1124
36-	36" deep	+\$1192

For 72" wide (72)

20-	20" deep	+\$882
24-	24" deep	+\$1097
30-	30" deep	+\$1178
36-	36" deep	+\$1257

Step 5. End Panels (from User Side)

SL	recessed end panel left, full end panel right	+\$0
LS	full end panel left, recessed end panel right	+\$0
LL	full end panel left, full end panel right	+\$0

Step 6. Steel Type

SS	smooth paint on smooth steel	+\$0
TS	smooth paint on textured steel	+\$0

Step 7. Understructure Finish

See Finish Colors list for paint codes.

Nonmetallic Paint		+\$0
Metallic Paint		+\$50

Step 8. Top

		48	60	66	72
NT	disposable top	-\$37	-37	-37	-37
TL	laminate top with vinyl edge	+\$0	0	0	0
TR	recut veneer top A	+\$367	399	412	426
TF	wood veneer top A	+\$433	471	486	500

Step 9.

Top Finish: Solid-Color Laminate

For laminate top with vinyl edge (TL)

8Q	folkstone grey	+\$0
91	white	+\$0
CL	cool grey neutral	+\$0
HF	inner tone light	+\$0
HT	inner tone	+\$0
LT	light tone	+\$0
LU	soft white	+\$0
WL	sandstone	+\$0
WN	warm grey neutral	+\$0

Top Finish: Fiber Laminate

For laminate top with vinyl edge (TL)

1X	vanilla	+\$0
2X	wheat	+\$0
3X	celery	+\$0
4X	coriander	+\$0
5X	chamomile	+\$0
6X	cinnamon	+\$0
7X	cardamom	+\$0
8X	kale	+\$0

Top Finish: Frosted Laminate		
<i>For laminate top with vinyl edge (TL)</i>		
J4	frosted light grey	+\$0
J5	frosted inner tone light	+\$0
J6	frosted slate grey	+\$0
J7	frosted medium tone	+\$0
J8	frosted black	+\$0

Top Finish: Wood-Grain Laminate		
<i>For laminate top with vinyl edge (TL)</i>		
LA	light ash	+\$0
LM	mahogany	+\$0

Top/Edge Finish: Recut Veneer		
<i>For recut veneer top (TR)</i>		
RA	light ash <input type="checkbox"/>	+\$0
RK	mahogany dark <input type="checkbox"/>	+\$0
RM	mahogany <input type="checkbox"/>	+\$0

Top/Edge Finish: Wood Veneer		
<i>For wood veneer top (TF)</i>		
V3	cherry <input type="checkbox"/>	+\$0
Z3	warm red cherry <input type="checkbox"/>	+\$0
Z5	maple <input type="checkbox"/>	+\$0
ED	aged cherry <input type="checkbox"/>	+\$20
EG	medium brown walnut <input type="checkbox"/>	+\$20
EK	medium red walnut <input type="checkbox"/>	+\$20
EY	light anigre <input type="checkbox"/>	+\$20
UL	natural maple <input type="checkbox"/>	+\$20
UQ	light cherry <input type="checkbox"/>	+\$20
UV	red cherry <input type="checkbox"/>	+\$20
UX	walnut on cherry <input type="checkbox"/>	+\$20

Step 10. Edge Finish		
<i>For laminate top with vinyl edge (TL)</i>		
8Q	folkstone grey	+\$0
91	white	+\$0
BU	black umber	+\$0
CL	cool grey neutral	+\$0
CM	cinnamon	+\$0
CO	chamomile	+\$0
G2	graphite satin	+\$0
HF	inner tone light	+\$0
HT	inner tone	+\$0
LA	light ash	+\$0
LM	mahogany	+\$0
LU	soft white	+\$0
MT	medium tone	+\$0
SG	slate grey	+\$0
WL	sandstone	+\$0
WN	warm grey neutral	+\$0

Step 11. Grommets		
NTG	no grommet	+\$0
L	grommet left	+\$27
C	grommet center	+\$27
R	grommet right	+\$27
2LC	grommets left and center	+\$53
2CR	grommets center and right	+\$53
2LR	grommets left and right	+\$53
3LCR	grommets left, center, and right	+\$79

Step 12. Grommet Finish		
<i>For grommet left (L), grommet center (C), grommet right (R), grommets left and center (2LC), grommets center and right (2CR), grommets left and right (2LR), or grommets left, center, and right (3LCR)</i>		
8Q	folkstone grey	+\$0
91	white	+\$0
BU	black umber	+\$0
CL	cool grey neutral	+\$0
HF	inner tone light	+\$0
LU	soft white	+\$0
MT	medium tone	+\$0
SG	slate grey	+\$0
WL	sandstone	+\$0
WN	warm grey neutral	+\$0

Desk with Single Pedestal

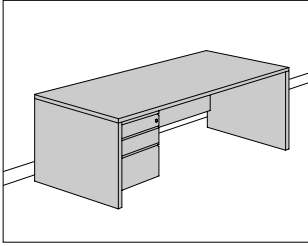

Product Information

Description

This desk connects to a 5000 Series desk component or stands alone. It has 1 lockable pedestal and a choice of pull and front styles (see chart below). Box drawers have 1 drawer divider. B- and F-pull file drawers hold letter-size front-to-back hanging files; they also include 2 file converters for legal-size filing. Standard-, contour-, and bevel-pull file drawers include 1 file compressor for letter-size front-to-back or side-to-side hanging files or legal-size side-to-side hanging files. File drawers have full-extension steel ball-bearing slides.

The desk has a laminate top and vinyl edge or a veneer top and edge and is available with or without grommets. A grommet is not available on the pedestal side of the desk. The desk has full or 10"-deep recessed end panels and 1" adjustable glides. 20"- and 24"-deep desks with recessed end panels have a cable management cutout at the back of the panel. The desk is available with a full, raised, or open back panel. The full back panel extends to the floor; the raised back panel is 8¹/₈" from the floor and provides access to electrical components in panel system raceways; the open back panel is used against architectural walls or panel systems and provides maximum access to electrical/data outlets, including those complying with ADA standards. The open back panel includes a horizontal support rail; the bottom of the support rail is 8¹/₈" from the floor.

Pull Style—Pull Material—Front Style

Standard—Metal pull—Wood Veneer front

Standard—Metal pull—Recut Veneer front

Standard—Metal pull—Metal front

Bevel—Metal pull—Metal front

Contour—Aluminum or Wood pull—Metal front

F-pull—Plastic pull—Metal front

B-pull—Plastic pull—Plastic front

Notes

30"- and 36"-deep desks have back panel recessed 4¹/₂" from visitor's side.

Pedestal must mount on side with full end panel.

To use desk freestanding, order with full end panels. To connect desk to a 5000 Series component, 1 recessed end panel may be required.

B- and F-pull pedestals have a smooth-steel case.

Box/box/file and file/file pedestal combinations with standard, contour, or bevel pulls hang 3³/₄" below raised back panel; box/box/file and file/file pedestal combinations with B and F pulls hang 6" below raised back panel.

Pedestals with standard, bevel, and contour pulls are 3⁷/₈" wider than pedestals with B and F pulls. Drawer accessories for pedestals with standard, bevel, and contour pulls are not interchangeable with accessories for pedestals with B and F pulls.

Order optional desk components separately:

- Bridge
- Return shell
- Return with single pedestal

To manage cables under desk, order cable management trough separately.

Order optional display or storage components separately:

- Desk-mounted tackboard
- Desk-mounted tool rail with tackboard
- End-mounted tackboard
- Flipper door unit

For accessory product applications, the following Compatibility Charts are available electronically for viewing and printing in Kiosk and HermanMiller.com: Keyboard Compatibility Charts, Pencil Drawer Compatibility Charts, and Work Organizer Compatibility Chart.

Pedestal ships with lock plugs keyed differently (KD). For keyed-alike locks on multiple pedestals, specify keyed alike (KA); separate lock plugs are shipped and field installed on each pedestal. See Keyed-Alike Information in Appendices.

Desk with Single Pedestal *continued*

Dimensions

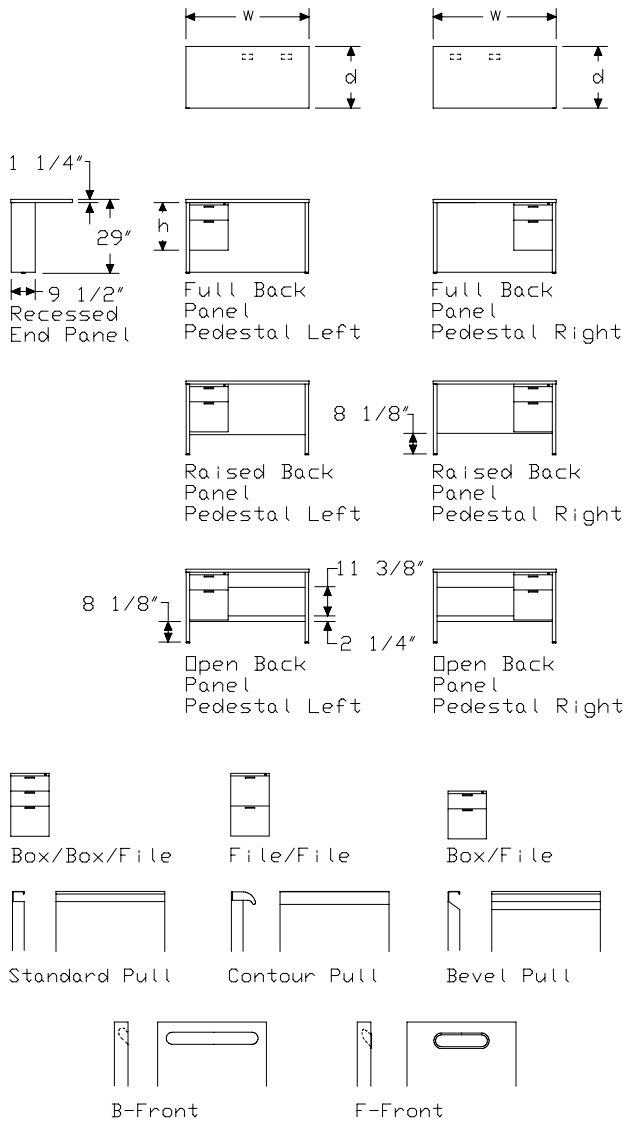

Specification Information

Step 1.
5

Step 2. Back Panel

F	full back panel	\$0
R	raised back panel	\$0
P	open back panel	\$0

Step 3. Pedestal Pull/Front Style

6-	standard pull with painted front	+\$171
R-	standard pull with recut veneer front A	+\$456
F-	standard pull with wood veneer front A	+\$482
5-	contour pull	+\$300
4-	bevel pull	+\$171
X-	B-pull	+\$146
Y-	F-pull	+\$118

Step 4. Width

48	48" wide	+\$0
60	60" wide	+\$0
66	66" wide	+\$0
72	72" wide	+\$0

Step 5. Depth

For standard pull with painted front (6-), standard pull with recut veneer front (R-), standard pull with wood veneer front (F-), contour pull (5-), or bevel pull (4-) with 48" wide (48)

24-	24" deep	+\$901
30-	30" deep	+\$941
36-	36" deep	+\$980

For standard pull with painted front (6-), standard pull with recut veneer front (R-), standard pull with wood veneer front (F-), contour pull (5-), or bevel pull (4-) with 60" wide (60)

20-	20" deep	+\$880
24-	24" deep	+\$985
30-	30" deep	+\$1032
36-	36" deep	+\$1086

For standard pull with painted front (6-), standard pull with recut veneer front (R-), standard pull with wood veneer front (F-), contour pull (5-), or bevel pull (4-) with 66" wide (66)

20-	20" deep	+\$922
24-	24" deep	+\$1021
30-	30" deep	+\$1086
36-	36" deep	+\$1152

For standard pull with painted front (6-), standard pull with recut veneer front (R-), standard pull with wood veneer front (F-), contour pull (5-), or bevel pull (4-) with 72" wide (72)

20-	20" deep	+\$953
24-	24" deep	+\$1057
30-	30" deep	+\$1152
36-	36" deep	+\$1271

For B-pull (X-) or F-pull (Y-) with 48" wide (48)

24-	24" deep	+\$901
30-	30" deep	+\$941
36-	36" deep	+\$980

For B-pull (X-) or F-pull (Y-) with 60" wide (60)

24-	24" deep	+\$985
30-	30" deep	+\$1032
36-	36" deep	+\$1086

For B-pull (X-) or F-pull (Y-) with 66" wide (66)

24-	24" deep	+\$1021
30-	30" deep	+\$1086
36-	36" deep	+\$1152

For B-pull (X-) or F-pull (Y-) with 72" wide (72)

24-	24" deep	+\$1057
30-	30" deep	+\$1152
36-	36" deep	+\$1271

Step 6. Configuration (from User Side)

SH	recessed end panel left, box/box/file right	+\$288
SG	recessed end panel left, file/file right	+\$249
SA	recessed end panel left, box/file right	+\$132
LH	full end panel left, box/box/file right	+\$288
LG	full end panel left, file/file right	+\$249
LA	full end panel left, box/file right	+\$132
HS	box/box/file left, recessed end panel right	+\$288
HL	box/box/file left, full end panel right	+\$288
GS	file/file left, recessed end panel right	+\$249
GL	file/file left, full end panel right	+\$249
AS	box/file left, recessed end panel right	+\$132
AL	box/file left, full end panel right	+\$132

Step 7. Steel Type

For standard pull with painted front (6-), standard pull with recut veneer front (R-), standard pull with wood veneer front (F-), contour pull (5-), or bevel pull (4-)

SS	smooth paint on smooth steel	+\$0
TS	smooth paint on textured steel	+\$0

For B-pull (X-) or F-pull (Y-)

SS	smooth paint on smooth steel	+\$0
-----------	------------------------------	------

Step 8. Understructure Finish

See Finish Colors list for paint codes.

For standard pull with painted front (6-), standard pull with recut veneer front (R-), standard pull with wood veneer front (F-), contour pull (5-), or bevel pull (4-)

Nonmetallic Paint	+\$0
Metallic Paint	+\$90

For B-pull (X-)

8Q	folkstone grey	+\$0
BU	black umber	+\$0
HF	inner tone light	+\$0
LT	light tone	+\$0
LU	soft white	+\$0
MT	medium tone	+\$0
SG	slate grey	+\$0
WL	sandstone	+\$0

Desk with Single Pedestal *continued*

For F-pull (Y-)		
8Q	folkstone grey	+\$0
BU	black umber	+\$0
HF	inner tone light	+\$0
LT	light tone	+\$0
LU	soft white	+\$0
MT	medium tone	+\$0
SG	slate grey	+\$0
WL	sandstone	+\$0
CN	metallic champagne	+\$90
EH	metallic bronze	+\$90
MS	metallic silver	+\$90

Step 9. Pull Type		
For contour pull (5-)		
1P	painted	+\$0
1S	stained A	+\$0

Step 10. Pull Finish
See *Finish Colors list for paint codes.*

For painted (1P)		
Nonmetallic Paint		+\$0
Metallic Paint		+\$0

Solid Woods		
For stained (1S)		
V3	cherry A	+\$0
Z3	warm red cherry A	+\$0
Z5	maple A	+\$0
ED	aged cherry A	+\$10
EG	medium brown walnut A	+\$10
EK	medium red walnut A	+\$10
EY	light anigre A	+\$10
UL	natural maple A	+\$10
UQ	light cherry A	+\$10
UV	red cherry A	+\$10
UX	walnut on cherry A	+\$10

Step 11. Top

For standard pull with painted front (6-), contour pull (5-), bevel pull (4-), B-pull (X-), or F-pull (Y-)

		48	60	66	72
NT	disposable top	-\$37	-37	-37	-37
TL	laminate top with vinyl edge	+\$0	0	0	0
TR	recut veneer top A	+\$367	399	412	426
TF	wood veneer top A	+\$433	471	486	500

For standard pull with recut veneer front (R-)

		48	60	66	72
TR	recut veneer top A	+\$367	399	412	426

For standard pull with wood veneer front (F-)

		48	60	66	72
TF	wood veneer top A	+\$433	471	486	500

Step 12.

Top Finish: Solid-Color Laminate

For laminate top with vinyl edge (TL)

8Q	folkstone grey	+\$0
91	white	+\$0
CL	cool grey neutral	+\$0
HF	inner tone light	+\$0
HT	inner tone	+\$0
LT	light tone	+\$0
LU	soft white	+\$0
WL	sandstone	+\$0
WN	warm grey neutral	+\$0

Top Finish: Fiber Laminate

For laminate top with vinyl edge (TL)

1X	vanilla	+\$0
2X	wheat	+\$0
3X	celery	+\$0
4X	coriander	+\$0
5X	chamomile	+\$0
6X	cinnamon	+\$0
7X	cardamom	+\$0
8X	kale	+\$0

Desk with Single Pedestal *continued*

Top Finish: Frosted Laminate		
<i>For laminate top with vinyl edge (TL)</i>		
J4	frosted light grey	+\$0
J5	frosted inner tone light	+\$0
J6	frosted slate grey	+\$0
J7	frosted medium tone	+\$0
J8	frosted black	+\$0

Top Finish: Wood-Grain Laminate		
<i>For laminate top with vinyl edge (TL)</i>		
LA	light ash	+\$0
LM	mahogany	+\$0

Top/Edge Finish: Recut Veneer		
<i>For standard pull with painted front (6-), contour pull (5-), bevel pull (4-), B-pull (X-), or F-pull (Y-) with recut veneer top (TR)</i>		
RA	light ash A	+\$0
RK	mahogany dark A	+\$0
RM	mahogany A	+\$0

Top/Edge Finish: Wood Veneer		
<i>For standard pull with painted front (6-), bevel pull (4-), B-pull (X-), or F-pull (Y-) with wood veneer top (TF)</i>		
V3	cherry A	+\$0
Z3	warm red cherry A	+\$0
Z5	maple A	+\$0
ED	aged cherry A	+\$20
EG	medium brown walnut A	+\$20
EK	medium red walnut A	+\$20
EY	light anigre A	+\$20
UL	natural maple A	+\$20
UQ	light cherry A	+\$20
UV	red cherry A	+\$20
UX	walnut on cherry A	+\$20

Front/Top/Edge Finish: Recut Veneer		
<i>For standard pull with recut veneer front (R-) with recut veneer top (TR)</i>		
RA	light ash A	+\$0
RK	mahogany dark A	+\$0
RM	mahogany A	+\$0

Front/Top/Edge Finish: Wood Veneer		
<i>For standard pull with wood veneer front (F-) with wood veneer top (TF)</i>		
V3	cherry A	+\$0
Z3	warm red cherry A	+\$0
Z5	maple A	+\$0
ED	aged cherry A	+\$35
EG	medium brown walnut A	+\$35
EK	medium red walnut A	+\$35
EY	light anigre A	+\$35
UL	natural maple A	+\$35
UQ	light cherry A	+\$35
UV	red cherry A	+\$35
UX	walnut on cherry A	+\$35

Top/Edge Finish: Wood Veneer		
<i>For contour pull (5-) with wood veneer top (TF)</i>		
V3	cherry A	+\$0
Z3	warm red cherry A	+\$0
Z5	maple A	+\$0

Step 13. Edge Finish		
<i>For laminate top with vinyl edge (TL)</i>		
8Q	folkstone grey	+\$0
91	white	+\$0
BU	black umber	+\$0
CL	cool grey neutral	+\$0
CM	cinnamon	+\$0
CO	chamomile	+\$0
G2	graphite satin	+\$0
HF	inner tone light	+\$0
HT	inner tone	+\$0
LA	light ash	+\$0
LM	mahogany	+\$0
LU	soft white	+\$0
MT	medium tone	+\$0
SG	slate grey	+\$0
WL	sandstone	+\$0
WN	warm grey neutral	+\$0

Desk with Single Pedestal *continued*

Step 14. Grommets

For recessed end panel left, box/box/file right (SH), recessed end panel left, file/file right (SG), recessed end panel left, box/file right (SA), full end panel left, box/box/file right (LH), full end panel left, file/file right (LG), or full end panel left, box/file right (LA)

NTG	no grommet	+\$0
L	grommet left	+\$27
C	grommet center	+\$27
2LC	grommets left and center	+\$53

For box/box/file left, recessed end panel right (HS), box/box/file left, full end panel right (HL), file/file left, recessed end panel right (GS), file/file left, full end panel right (GL), box/file left, recessed end panel right (AS), or box/file left, full end panel right (AL)

NTG	no grommet	+\$0
R	grommet right	+\$27
C	grommet center	+\$27
2CR	grommets center and right	+\$53

Step 15. Grommet Finish

For grommet left (L), grommet right (R), grommet center (C), grommets center and right (2CR), or grommets left and center (2LC)

8Q	folkstone grey	+\$0
91	white	+\$0
BU	black umber	+\$0
CL	cool grey neutral	+\$0
HF	inner tone light	+\$0
LU	soft white	+\$0
MT	medium tone	+\$0
SG	slate grey	+\$0
WL	sandstone	+\$0
WN	warm grey neutral	+\$0

Step 16. Lock

For standard pull with painted front (6-), standard pull with recut veneer front (R-), standard pull with wood veneer front (F-), contour pull (5-), or bevel pull (4-)

KD	keyed differently with black lock	+\$0
KC	keyed differently with chrome lock	+\$0
KA	keyed alike	+\$0

For B-pull (X-) or F-pull (Y-)

KD	keyed differently with black lock	+\$0
KA	keyed alike	+\$0

Desk with Double Pedestal

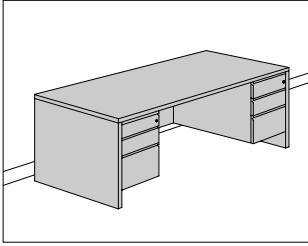

Product Information

Description

This freestanding desk has 2 lockable pedestals and a choice of pull and front styles (see chart below). Box drawers have 1 drawer divider. B- and F-pull file drawers hold letter-size front-to-back hanging files; they also include 2 file converters for legal-size filing. Standard-, contour-, and bevel-pull file drawers include 1 file compressor for letter-size front-to-back or side-to-side hanging files or legal-size side-to-side hanging files. File drawers have full-extension steel ball-bearing slides.

The desk has a laminate top and vinyl edge or a veneer top and edge and is available with a center grommet or no grommet. It is available with a full, raised, or open back panel. The full back panel extends to the floor; the raised back panel is 8 1/8" from the floor and provides access to electrical components in panel system raceways; the open back panel is used against architectural walls and provides maximum access to electrical/data outlets, including those complying with ADA standards. The open back panel includes a horizontal support rail; the bottom of the support rail is 8 1/8" from the floor.

Pull Style—Pull Material—Front Style

- Standard—Metal pull—Wood Veneer front
- Standard—Metal pull—Recut Veneer front
- Standard—Metal pull—Metal front
- Bevel—Metal pull—Metal front
- Contour—Aluminum or Wood pull—Metal front
- F-pull—Plastic pull—Metal front
- B-pull—Plastic pull—Plastic front

Notes

30"- and 36"-deep desks have back panel recessed 4 1/2" from visitor's side.

Pedestals on each side of desk should be same height.

B- and F-pull pedestals have a smooth-steel case.

Box/box/file and file/file pedestal combinations with standard, contour, or bevel pulls hang 3 3/4" below raised back panel; box/box/file and file/file pedestal combinations with B and F pulls hang 6" below raised back panel.

Pedestals with standard, bevel, and contour pulls are 3/8" wider than pedestals with B and F pulls. Drawer accessories for pedestals with standard, bevel, and contour pulls are not interchangeable with accessories for pedestals with B and F pulls.

To manage cables under desk, order cable management trough separately.

Order optional display or storage components separately:

- Desk-mounted tackboard
- Desk-mounted tool rail with tackboard
- End-mounted tackboard
- Flipper door unit

For accessory product applications, the following Compatibility Charts are available electronically for viewing and printing in Kiosk and HermanMiller.com: Keyboard Compatibility Charts, Pencil Drawer Compatibility Charts, and Work Organizer Compatibility Chart.

For keyed-alike desks, specify keyed alike (KA); separate lock plugs are shipped and field installed on each pedestal. See Keyed-Alike Information in Appendices.

For keyed differently locks on each pedestal in the same desk, contact Customer Care.

Dimensions

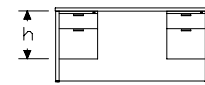
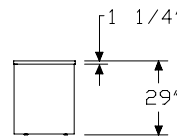
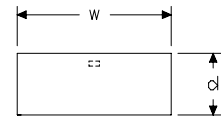

Full Back Panel

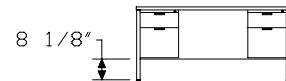

Raised Back Panel

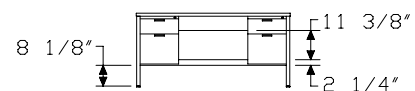

Open Back Panel



Box/Box/File



File/File



Box/File



Standard Pull



Contour Pull



Bevel Pull

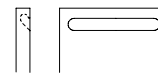

B-Front

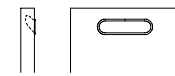

F-Front

Specification Information

Step 1.

5

Step 2. Back Panel

F	full back panel	\$0
R	raised back panel	\$0
P	open back panel	\$0

Step 3. Pedestal Pull/Front Style

6-	standard pull with painted front	+\$339
R-	standard pull with recut veneer front A	+\$908
F-	standard pull with wood veneer front A	+\$960
5-	contour pull	+\$598
4-	bevel pull	+\$339
X-	B-pull	+\$288
Y-	F-pull	+\$235

Step 4. Width

60	60" wide	+\$0
66	66" wide	+\$0
72	72" wide	+\$0

Step 5. Depth

For standard pull with painted front (6-), standard pull with recut veneer front (R-), standard pull with wood veneer front (F-), contour pull (5-), or bevel pull (4-) with 60" wide (60)

20-	20" deep	+\$836
24-	24" deep	+\$907
30-	30" deep	+\$980
36-	36" deep	+\$1032

For standard pull with painted front (6-), standard pull with recut veneer front (R-), standard pull with wood veneer front (F-), contour pull (5-), or bevel pull (4-) with 66" wide (66)

20-	20" deep	+\$861
24-	24" deep	+\$953
30-	30" deep	+\$1021
36-	36" deep	+\$1100

For standard pull with painted front (6-), standard pull with recut veneer front (R-), standard pull with wood veneer front (F-), contour pull (5-), or bevel pull (4-) with 72" wide (72)

20-	20" deep	+\$888
24-	24" deep	+\$994
30-	30" deep	+\$1086
36-	36" deep	+\$1257

For B-pull (X-) or F-pull (Y-) with 60" wide (60)

24-	24" deep	+\$907
30-	30" deep	+\$980
36-	36" deep	+\$1032

For B-pull (X-) or F-pull (Y-) with 66" wide (66)

24-	24" deep	+\$953
30-	30" deep	+\$1021
36-	36" deep	+\$1100

For B-pull (X-) or F-pull (Y-) with 72" wide (72)

24-	24" deep	+\$994
30-	30" deep	+\$1086
36-	36" deep	+\$1257

Step 6. Configuration (from User Side)

HH	box/box/file left, box/box/file right	+\$573
HG	box/box/file left, file/file right	+\$534
GH	file/file left, box/box/file right	+\$534
GG	file/file left, file/file right	+\$493
AA	box/file left, box/file right	+\$261

Step 7. Steel Type

For standard pull with painted front (6-), standard pull with recut veneer front (R-), standard pull with wood veneer front (F-), contour pull (5-), or bevel pull (4-)

SS	smooth paint on smooth steel	+\$0
TS	smooth paint on textured steel	+\$0

For B-pull (X-) or F-pull (Y-)

SS	smooth paint on smooth steel	+\$0
-----------	------------------------------	------

Desk with Double Pedestal *continued*

Step 8. Understructure Finish
See *Finish Colors* list for paint codes.

For standard pull with painted front (6-), standard pull with recut veneer front (R-), standard pull with wood veneer front (F-), contour pull (5-), or bevel pull (4-)

Nonmetallic Paint	+\$0
Metallic Paint	+\$120

For B-pull (X-)

8Q folkstone grey	+\$0
BU black umber	+\$0
HF inner tone light	+\$0
LT light tone	+\$0
LU soft white	+\$0
MT medium tone	+\$0
SG slate grey	+\$0
WL sandstone	+\$0

For F-pull (Y-)

8Q folkstone grey	+\$0
BU black umber	+\$0
HF inner tone light	+\$0
LT light tone	+\$0
LU soft white	+\$0
MT medium tone	+\$0
SG slate grey	+\$0
WL sandstone	+\$0
CN metallic champagne	+\$120
EH metallic bronze	+\$120
MS metallic silver	+\$120

Step 9. Pull Type

For contour pull (5-)

1P painted	+\$0
1S stained A	+\$0

Step 10. Pull Finish

See *Finish Colors* list for paint codes.

For painted (1P)

Nonmetallic Paint	+\$0
Metallic Paint	+\$0

Solid Woods

For stained (1S)

V3 cherry A	+\$0
Z3 warm red cherry A	+\$0
Z5 maple A	+\$0
ED aged cherry A	+\$20
EG medium brown walnut A	+\$20
EK medium red walnut A	+\$20
EY light anigre A	+\$20
UL natural maple A	+\$20
UQ light cherry A	+\$20
UV red cherry A	+\$20
UX walnut on cherry A	+\$20

Step 11. Top

For standard pull with painted front (6-), contour pull (5-), bevel pull (4-), B-pull (X-), or F-pull (Y-)

	60	66	72
NT disposable top	-\$37	-37	-37
TL laminate top with vinyl edge	+\$0	0	0
TR recut veneer top A	+\$399	412	426
TF wood veneer top A	+\$471	486	500

For standard pull with recut veneer front (R-)

	60	66	72
TR recut veneer top A	+\$399	412	426

For standard pull with wood veneer front (F-)

	60	66	72
TF wood veneer top A	+\$471	486	500

Step 12.

Top Finish: Solid-Color Laminate

For laminate top with vinyl edge (TL)

8Q folkstone grey	+\$0
91 white	+\$0
CL cool grey neutral	+\$0
HF inner tone light	+\$0
HT inner tone	+\$0
LT light tone	+\$0
LU soft white	+\$0
WL sandstone	+\$0
WN warm grey neutral	+\$0

Top Finish: Fiber Laminate		
<i>For laminate top with vinyl edge (TL)</i>		
1X	vanilla	+\$0
2X	wheat	+\$0
3X	celery	+\$0
4X	coriander	+\$0
5X	chamomile	+\$0
6X	cinnamon	+\$0
7X	cardamom	+\$0
8X	kale	+\$0

Top Finish: Frosted Laminate		
<i>For laminate top with vinyl edge (TL)</i>		
J4	frosted light grey	+\$0
J5	frosted inner tone light	+\$0
J6	frosted slate grey	+\$0
J7	frosted medium tone	+\$0
J8	frosted black	+\$0

Top Finish: Wood-Grain Laminate		
<i>For laminate top with vinyl edge (TL)</i>		
LA	light ash	+\$0
LM	mahogany	+\$0

Top/Edge Finish: Recut Veneer		
<i>For standard pull with painted front (6-), contour pull (5-), bevel pull (4-), B-pull (X-), or F-pull (Y-) with recut veneer top (TR)</i>		
RA	light ash A	+\$0
RK	mahogany dark A	+\$0
RM	mahogany matte A	+\$0

Top/Edge Finish: Wood Veneer		
<i>For standard pull with painted front (6-), bevel pull (4-), B-pull (X-), or F-pull (Y-) with wood veneer top (TF)</i>		
V3	cherry A	+\$0
Z3	warm red cherry A	+\$0
Z5	maple A	+\$0
ED	aged cherry A	+\$20
EG	medium brown walnut A	+\$20
EK	medium red walnut A	+\$20
EY	light anigre A	+\$20
UL	natural maple A	+\$20
UQ	light cherry A	+\$20
UV	red cherry A	+\$20
UX	walnut on cherry A	+\$20

Front/Top/Edge Finish: Recut Veneer		
<i>For standard pull with recut veneer front (R-) with recut veneer top (TR)</i>		
RA	light ash A	+\$0
RK	mahogany dark A	+\$0
RM	mahogany A	+\$0

Front/Top/Edge Finish: Wood Veneer		
<i>For standard pull with wood veneer front (F-) with wood veneer top (TF)</i>		
V3	cherry A	+\$0
Z3	warm red cherry A	+\$0
Z5	maple A	+\$0
ED	aged cherry A	+\$70
EG	medium brown walnut A	+\$70
EK	medium red walnut A	+\$70
EY	light anigre A	+\$70
UL	natural maple A	+\$70
UQ	light cherry A	+\$70
UV	red cherry A	+\$70
UX	walnut on cherry A	+\$70

Top/Edge Finish: Wood Veneer		
<i>For contour pull (5-) with wood veneer top (TF)</i>		
V3	cherry A	+\$0
Z3	warm red cherry A	+\$0
Z5	maple A	+\$0

Step 13. Edge Finish		
<i>For laminate top with vinyl edge (TL)</i>		
8Q	folkstone grey	+\$0
91	white	+\$0
BU	black umber	+\$0
CL	cool grey neutral	+\$0
CM	cinnamon	+\$0
CO	chamomile	+\$0
G2	graphite satin	+\$0
HF	inner tone light	+\$0
HT	inner tone	+\$0
LA	light ash	+\$0
LM	mahogany	+\$0
LU	soft white	+\$0
MT	medium tone	+\$0
SG	slate grey	+\$0
WL	sandstone	+\$0
WN	warm grey neutral	+\$0

Desk with Double Pedestal *continued*

Step 14. Grommets		
NTG	no grommet	+\$0
C	grommet center	+\$27

Step 15. Grommet Finish		
<i>For grommet center (C)</i>		
8Q	folkstone grey	+\$0
91	white	+\$0
BU	black umber	+\$0
CL	cool grey neutral	+\$0
HF	inner tone light	+\$0
LU	soft white	+\$0
MT	medium tone	+\$0
SG	slate grey	+\$0
WL	sandstone	+\$0
WN	warm grey neutral	+\$0

Step 16. Lock		
<i>For standard pull with painted front (6-), standard pull with recut veneer front (R-), standard pull with wood veneer front (F-), contour pull (5-), or bevel pull (4-)</i>		
KD	keyed differently with black lock	+\$0
KC	keyed differently with chrome lock	+\$0
KA	keyed alike	+\$0

<i>For B-pull (X-) or F-pull (Y-)</i>		
KD	keyed differently with black lock	+\$0
KA	keyed alike	+\$0

Corner Desk

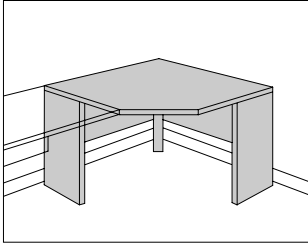

Product Information

Description

This straight-edged 90° corner desk connects to a 5000 Series component or stands alone. It has a laminate top and vinyl edge or a veneer top and edge and is available with or without grommets. The desk has full or 10"-deep recessed end panels and 1" adjustable glides. 20"- and 24"-deep desks with recessed end panels have a cable management cutout at the back of the panel. The desk is available with a full, raised, or open back panel. The full back panel extends to the floor; the raised back panel is 8 1/8" from the floor and provides access to electrical components in panel system raceways; the open back panel is used against architectural walls or panel systems and provides maximum access to electrical/data outlets, including those complying with ADA standards. The open back panel includes a horizontal support rail; the bottom of the support rail is 8 1/8" from the floor.

Notes

To use corner desk at end of furniture run, specify full end panel.

To connect corner desk to return or bridge and maximize work surface space, use following guidelines:

- 20"-deep corner desk connects to 20"-deep return or bridge without corner cuts
- 20"-deep corner desk connects to 24"-deep corner desk return or bridge with 4" corner cuts
- 24"-deep corner desk connects to 24"-deep return or bridge without corner cuts
- 24"-deep corner desk connects to 30"-deep corner desk return or bridge with 6" corner cuts

Order optional desk components separately:

- Bridge
- Corner bridge
- Corner return shell
- Corner return with single pedestal
- Return shell
- Return with single pedestal

To manage cables under corner desk, order cable management trough separately.

Order optional display or storage components separately:

- Corner desk-mounted tackboard
- Flipper door unit

For accessory product applications, the following Compatibility Charts are available electronically for viewing and printing in Kiosk and HermanMiller.com: Keyboard Compatibility Charts, Pencil Drawer Compatibility Charts, and Work Organizer Compatibility Chart.

Dimensions

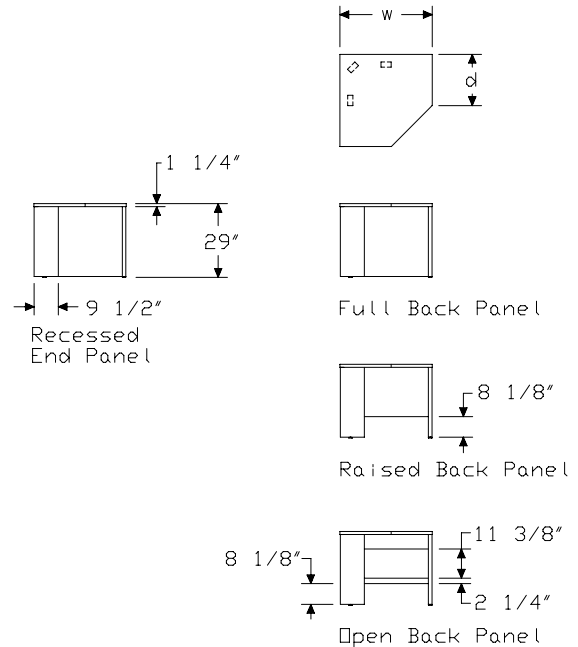

Specification Information		
Step 1.		
5		
Step 2. Back Panel		
F0-	full back panel	\$0
R0-	raised back panel	\$0
P0-	open back panel	\$0
Step 3. Width		
3636	36" wide	+\$0
4242	42" wide	+\$0
4848	48" wide	+\$0
Step 4. Depth		
<i>For 36" wide (3636)</i>		
20-	20" deep	+\$830
<i>For 42" wide (4242)</i>		
20-	20" deep	+\$912
24-	24" deep	+\$941
<i>For 48" wide (4848)</i>		
24-	24" deep	+\$1055
30-	30" deep	+\$1194
Step 5. End Panels (from User Side)		
SS	recessed end panel left, recessed end panel right	+\$0
SL	recessed end panel left, full end panel right	+\$0
LS	full end panel left, recessed end panel right	+\$0
LL	full end panel left, full end panel right	+\$0
Step 6. Steel Type		
SS	smooth paint on smooth steel	+\$0
TS	smooth paint on textured steel	+\$0
Step 7. Understructure Finish		
<i>See Finish Colors list for paint codes.</i>		
Nonmetallic Paint		+\$0
Metallic Paint		+\$60
Step 8. Top		
NT	disposable top	-\$37
TL	laminated top with vinyl edge	+\$0
TR	recut veneer top <input type="checkbox"/>	+\$329
TF	wood veneer top <input type="checkbox"/>	+\$388

Step 9.		
Top Finish: Solid-Color Laminate		
<i>For laminate top with vinyl edge (TL)</i>		
8Q	folkstone grey	+\$0
91	white	+\$0
CL	cool grey neutral	+\$0
HF	inner tone light	+\$0
HT	inner tone	+\$0
LT	light tone	+\$0
LU	soft white	+\$0
WL	sandstone	+\$0
WN	warm grey neutral	+\$0
Top Finish: Fiber Laminate		
<i>For laminate top with vinyl edge (TL)</i>		
1X	vanilla	+\$0
2X	wheat	+\$0
3X	celery	+\$0
4X	coriander	+\$0
5X	chamomile	+\$0
6X	cinnamon	+\$0
7X	cardamom	+\$0
8X	kale	+\$0
Top Finish: Frosted Laminate		
<i>For laminate top with vinyl edge (TL)</i>		
J4	frosted light grey	+\$0
J5	frosted inner tone light	+\$0
J6	frosted slate grey	+\$0
J7	frosted medium tone	+\$0
J8	frosted black	+\$0
Top Finish: Wood-Grain Laminate		
<i>For laminate top with vinyl edge (TL)</i>		
LA	light ash	+\$0
LM	mahogany	+\$0
Top/Edge Finish: Recut Veneer		
<i>For recut veneer top (TR)</i>		
RA	light ash <input type="checkbox"/>	+\$0
RK	mahogany dark <input type="checkbox"/>	+\$0
RM	mahogany <input type="checkbox"/>	+\$0

Top/Edge Finish: Wood Veneer

For wood veneer top (TF)

V3	cherry <input type="checkbox"/> A	+\$0
Z3	warm red cherry <input type="checkbox"/> A	+\$0
Z5	maple <input type="checkbox"/> A	+\$0
ED	aged cherry <input type="checkbox"/> A	+\$30
EG	medium brown walnut <input type="checkbox"/> A	+\$30
EK	medium red walnut <input type="checkbox"/> A	+\$30
EY	light anigre <input type="checkbox"/> A	+\$30
UX	walnut on cherry <input type="checkbox"/> A	+\$30
UL	natural maple <input type="checkbox"/> A	+\$30
UQ	light cherry <input type="checkbox"/> A	+\$30
UV	red cherry <input type="checkbox"/> A	+\$30

Step 10. Edge Finish

For laminate top with vinyl edge (TL)

8Q	folkstone grey	+\$0
91	white	+\$0
BU	black umber	+\$0
CL	cool grey neutral	+\$0
CM	cinnamon	+\$0
CO	chamomile	+\$0
G2	graphite satin	+\$0
HF	inner tone light	+\$0
HT	inner tone	+\$0
LA	light ash	+\$0
LM	mahogany	+\$0
LU	soft white	+\$0
MT	medium tone	+\$0
SG	slate grey	+\$0
WL	sandstone	+\$0
WN	warm grey neutral	+\$0

Step 11. Grommets

NTG	no grommet	+\$0
C	grommet center	+\$27
L	grommet left	+\$27
R	grommet right	+\$27
2LC	grommets left and center	+\$53
2CR	grommets center and right	+\$53
2LR	grommets left and right	+\$53
3LCR	grommets left, center, and right	+\$79

Step 12. Grommet Finish

For grommet center (C), grommet left (L), grommet right (R), grommets left and center (2LC), grommets center and right (2CR), grommets left and right (2LR), or grommets left, center, and right (3LCR)

8Q	folkstone grey	+\$0
91	white	+\$0
BU	black umber	+\$0
CL	cool grey neutral	+\$0
HF	inner tone light	+\$0
LU	soft white	+\$0
MT	medium tone	+\$0
SG	slate grey	+\$0
WL	sandstone	+\$0
WN	warm grey neutral	+\$0

Curved Corner Desk

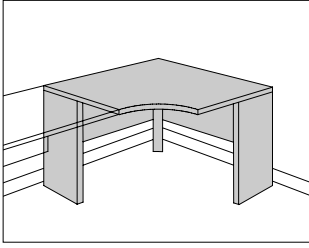

Product Information

Description

This 90° curved corner desk connects to a 5000 Series component or stands alone. It has a laminate top and vinyl edge or a veneer top and edge and is available with or without grommets. The desk has full or 10"-deep recessed end panels and 1" adjustable glides. 20"- and 24"-deep desks with recessed end panels have a cable management cutout at the back of the panel. The desk is available with a full, raised, or open back panel. The full back panel extends to the floor; the raised back panel is 8 1/8" from the floor and provides access to electrical components in panel system raceways; the open back panel is used against architectural walls and provides maximum access to electrical/data outlets, including those complying with ADA standards. The open back panel includes a horizontal support rail; the bottom of the support rail is 8 1/8" from the floor.

Notes

To use curved corner desk at end of furniture run, specify full end panel. For aesthetic reasons, curved corner desk should not attach to a corner return or corner bridge with corner cuts.

Order optional desk components separately:

- Bridge
- Return shell
- Return with single pedestal

To manage cables under desk, order cable management trough separately.

Order optional display or storage components separately:

- Corner desk-mounted tackboard
- Flipper door unit

For accessory product applications, the following Compatibility Charts are available electronically for viewing and printing in Kiosk and HermanMiller.com: Keyboard Compatibility Charts, Pencil Drawer Compatibility Charts, and Work Organizer Compatibility Chart.

Dimensions

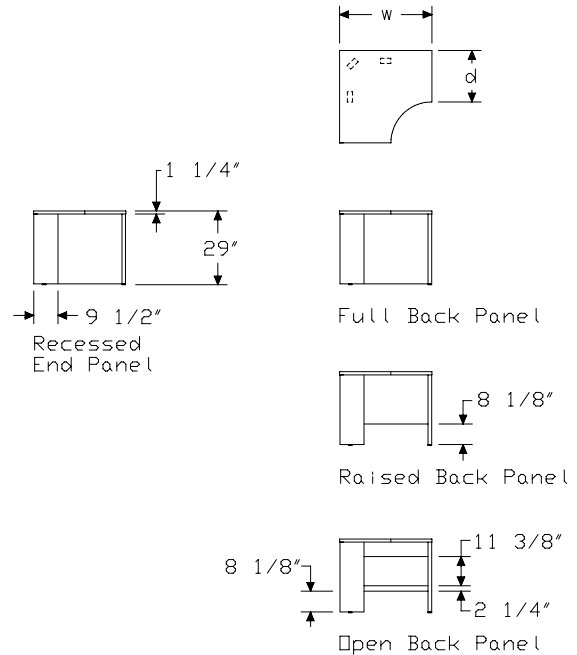

Specification Information		
Step 1.		
5		
Step 2. Back Panel		
F0-	full back panel	\$0
R0-	raised back panel	\$0
P0-	open back panel	\$0
Step 3. Width		
3636	36" wide	+\$0
4242	42" wide	+\$0
4848	48" wide	+\$0
Step 4. Depth		
<i>For 36" wide (3636)</i>		
20-C	20" deep	+\$872
<i>For 42" wide (4242)</i>		
20-C	20" deep	+\$960
24-C	24" deep	+\$987
<i>For 48" wide (4848)</i>		
24-C	24" deep	+\$1111
30-C	30" deep	+\$1236
Step 5. End Panels (from User Side)		
SS	recessed end panel left, recessed end panel right	+\$0
SL	recessed end panel left, full end panel right	+\$0
LS	full end panel left, recessed end panel right	+\$0
LL	full end panel left, full end panel right	+\$0
Step 6. Steel Type		
SS	smooth paint on smooth steel	+\$0
TS	smooth paint on textured steel	+\$0
Step 7. Understructure Finish		
<i>See Finish Colors list for paint codes.</i>		
Nonmetallic Paint		+\$0
Metallic Paint		+\$60
Step 8. Top		
NT	disposable top	-\$37
TL	laminated top with vinyl edge	+\$0
TR	recut veneer top <input type="checkbox"/>	+\$329
TF	wood veneer top <input type="checkbox"/>	+\$388

Step 9.		
Top Finish: Solid-Color Laminate		
<i>For laminate top with vinyl edge (TL)</i>		
8Q	folkstone grey	+\$0
91	white	+\$0
CL	cool grey neutral	+\$0
HF	inner tone light	+\$0
HT	inner tone	+\$0
LT	light tone	+\$0
LU	soft white	+\$0
WL	sandstone	+\$0
WN	warm grey neutral	+\$0
Top Finish: Fiber Laminate		
<i>For laminate top with vinyl edge (TL)</i>		
1X	vanilla	+\$0
2X	wheat	+\$0
3X	celery	+\$0
4X	coriander	+\$0
5X	chamomile	+\$0
6X	cinnamon	+\$0
7X	cardamom	+\$0
8X	kale	+\$0
Top Finish: Frosted Laminate		
<i>For laminate top with vinyl edge (TL)</i>		
J4	frosted light grey	+\$0
J5	frosted inner tone light	+\$0
J6	frosted slate grey	+\$0
J7	frosted medium tone	+\$0
J8	frosted black	+\$0
Top Finish: Wood-Grain Laminate		
<i>For laminate top with vinyl edge (TL)</i>		
LA	light ash	+\$0
LM	mahogany	+\$0
Top/Edge Finish: Recut Veneer		
<i>For recut veneer top (TR)</i>		
RA	light ash <input type="checkbox"/>	+\$0
RK	mahogany dark <input type="checkbox"/>	+\$0
RM	mahogany <input type="checkbox"/>	+\$0

Top/Edge Finish: Wood Veneer		
<i>For wood veneer top (TF)</i>		
V3	cherry A	+\$0
Z3	warm red cherry A	+\$0
Z5	maple A	+\$0
ED	aged cherry A	+\$30
EG	medium brown walnut A	+\$30
EK	medium red walnut A	+\$30
EY	light anigre A	+\$30
UL	natural maple A	+\$30
UQ	light cherry A	+\$30
UV	red cherry A	+\$30
UX	walnut on cherry A	+\$30

Step 10. Edge Finish		
<i>For laminate top with vinyl edge (TL)</i>		
8Q	folkstone grey	+\$0
91	white	+\$0
BU	black umber	+\$0
CL	cool grey neutral	+\$0
CM	cinnamon	+\$0
CO	chamomile	+\$0
G2	graphite satin	+\$0
HF	inner tone light	+\$0
HT	inner tone	+\$0
LA	light ash	+\$0
LM	mahogany	+\$0
LU	soft white	+\$0
MT	medium tone	+\$0
SG	slate grey	+\$0
WL	sandstone	+\$0
WN	warm grey neutral	+\$0

Step 11. Grommets		
NTG	no grommet	+\$0
L	grommet left	+\$27
C	grommet center	+\$27
R	grommet right	+\$27
2LC	grommets left and center	+\$53
2CR	grommets center and right	+\$53
2LR	grommets left and right	+\$53
3LCR	grommets left, center, and right	+\$79

Step 12. Grommet Finish		
<i>For grommet left (L), grommet center (C), grommet right (R), grommets left and center (2LC), grommets center and right (2CR), grommets left and right (2LR), or grommets left, center, and right (3LCR)</i>		
8Q	folkstone grey	+\$0
91	white	+\$0
BU	black umber	+\$0
CL	cool grey neutral	+\$0
HF	inner tone light	+\$0
LU	soft white	+\$0
MT	medium tone	+\$0
SG	slate grey	+\$0
WL	sandstone	+\$0
WN	warm grey neutral	+\$0

Curved Corner Desk with D-Shaped Peninsula

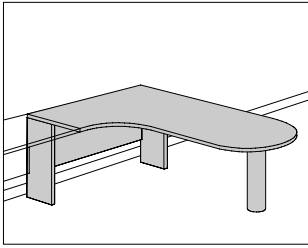

Product Information

Description

This 90° corner D-shaped peninsula desk connects to a 5000 Series component or stands alone. It has a laminate top and vinyl edge or a veneer top and edge and is available with or without grommets. The desk has a curved work surface, a column base, full or 10"-deep recessed end panels, and 1" adjustable glides. The desk with recessed end panels has a cable management cutout at the back of the panel. The desk is available with a full, raised, or open back panel. The full back panel extends to the floor; the raised back panel is 8 1/8" from the floor and provides access to electrical components in panel system raceways; the open back panel is used against architectural walls and provides maximum access to electrical/data outlets, including those complying with ADA standards. The open back panel includes a horizontal support rail; the bottom of the support rail is 8 1/8" from the floor.

Notes

Order optional desk components separately:

- Bridge
- Return shell
- Return with single pedestal

To manage cables under peninsula desk, order cable management trough separately.

Order optional display or storage components separately:

- Desk-mounted tackboard
- Desk-mounted tool rail with tackboard
- End-mounted tackboard
- Flipper door unit

For accessory product applications, the following Compatibility Charts are available electronically for viewing and printing in Kiosk and HermanMiller.com: Keyboard Compatibility Charts, Pencil Drawer Compatibility Charts, and Work Organizer Compatibility Chart.

Dimensions

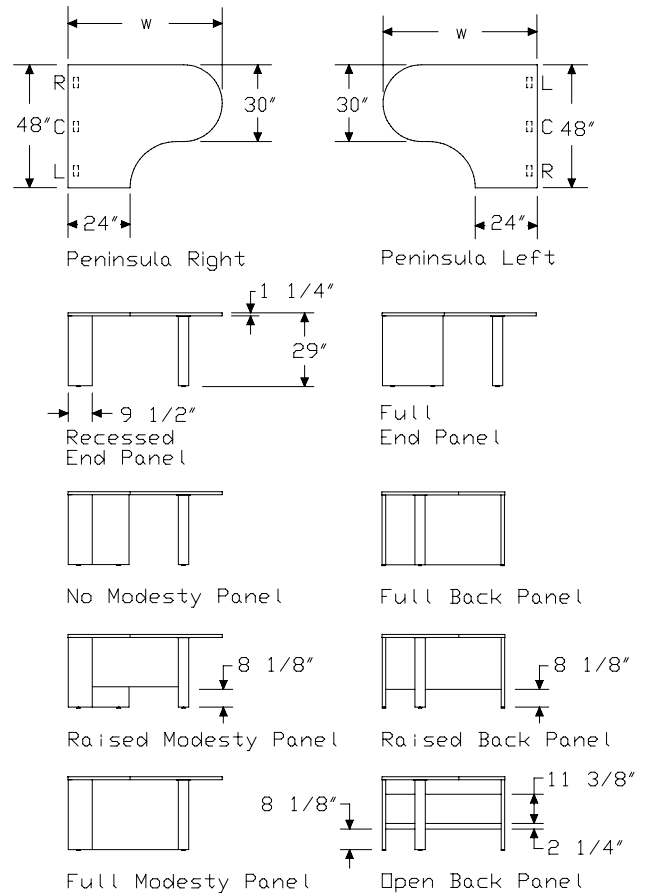

Curved Corner Desk with D-Shaped Peninsula *continued*

Specification Information

Step 1.

5

Step 2. Back Panel

F0-	full back panel	\$0
R0-	raised back panel	\$0
P0-	open back panel	\$0

Step 3. Width/Position (from User Side)

486024-D	60"-wide peninsula right	+\$1207
486624-D	66"-wide peninsula right	+\$1258
487224-D	72"-wide peninsula right	+\$1311
604824-D	60"-wide peninsula left	+\$1207
664824-D	66"-wide peninsula left	+\$1258
724824-D	72"-wide peninsula left	+\$1311

Step 4. End Panels (from User Side)

SS	recessed end panel left, recessed end panel right	+\$0
SL	recessed end panel left, full end panel right	+\$0
LS	full end panel left, recessed end panel right	+\$0
LL	full end panel left, full end panel right	+\$0

Step 5. Modesty Panel

For full back panel (Fo-)

NP	no modesty panel	+\$0
MP	full modesty panel	+\$187

For raised back panel (Ro-) or open back panel (Po-)

NP	no modesty panel	+\$0
SP	raised modesty panel	+\$164

Step 6. Steel Type

SS	smooth paint on smooth steel	+\$0
TS	smooth paint on textured steel	+\$0

Step 7. Understructure Finish

See *Finish Colors list for paint codes.*

Nonmetallic Paint	+\$0
Metallic Paint	+\$40

Step 8. Top

		486024-D	486624-D	487224-D	604824-D
NT	disposable top	-\$37	-37	-37	-37
TL	laminate top with vinyl edge	+\$0	0	0	0
TR	recut veneer top A	+\$593	618	642	593
TF	wood veneer top A	+\$700	707	713	700
				664824-D	724824-D
NT	disposable top			-\$37	-37
TL	laminate top with vinyl edge			+\$0	0
TR	recut veneer top A			+\$618	642
TF	wood veneer top A			+\$707	713

Step 9.

Top Finish: Solid-Color Laminate

For laminate top with vinyl edge (TL)

8Q	folkstone grey	+\$0
91	white	+\$0
CL	cool grey neutral	+\$0
HF	inner tone light	+\$0
HT	inner tone	+\$0
LT	light tone	+\$0
LU	soft white	+\$0
WL	sandstone	+\$0
WN	warm grey neutral	+\$0

Top Finish: Fiber Laminate

For laminate top with vinyl edge (TL)

1X	vanilla	+\$0
2X	wheat	+\$0
3X	celery	+\$0
4X	coriander	+\$0
5X	chamomile	+\$0
6X	cinnamon	+\$0
7X	cardamom	+\$0
8X	kale	+\$0

Top Finish: Frosted Laminate

For laminate top with vinyl edge (TL)

J4	frosted light grey	+\$0
J5	frosted inner tone light	+\$0
J6	frosted slate grey	+\$0
J7	frosted medium tone	+\$0
J8	frosted black	+\$0

Curved Corner Desk with D- Shaped Peninsula *continued*

Top Finish: Wood-Grain Laminate		
<i>For laminate top with vinyl edge (TL)</i>		
LA	light ash	+\$0
LM	mahogany	+\$0

Top/Edge Finish: Recut Veneer		
<i>For recut veneer top (TR)</i>		
RA	light ash <input type="checkbox"/> A	+\$0
RK	mahogany dark <input type="checkbox"/> A	+\$0
RM	mahogany <input type="checkbox"/> A	+\$0

Top/Edge Finish: Wood Veneer		
<i>For wood veneer top (TF)</i>		
V3	cherry <input type="checkbox"/> A	+\$0
Z3	warm red cherry <input type="checkbox"/> A	+\$0
Z5	maple <input type="checkbox"/> A	+\$0
ED	aged cherry <input type="checkbox"/> A	+\$50
EG	medium brown walnut <input type="checkbox"/> A	+\$50
EK	medium red walnut <input type="checkbox"/> A	+\$50
EY	light anigre <input type="checkbox"/> A	+\$50
UL	natural maple <input type="checkbox"/> A	+\$50
UQ	light cherry <input type="checkbox"/> A	+\$50
UV	red cherry <input type="checkbox"/> A	+\$50
UX	walnut on cherry <input type="checkbox"/> A	+\$50

Step 10. Edge Finish		
<i>For laminate top with vinyl edge (TL)</i>		
8Q	folkstone grey	+\$0
91	white	+\$0
BU	black umber	+\$0
CL	cool grey neutral	+\$0
CM	cinnamon	+\$0
CO	chamomile	+\$0
G2	graphite satin	+\$0
HF	inner tone light	+\$0
HT	inner tone	+\$0
LA	light ash	+\$0
LM	mahogany	+\$0
LU	soft white	+\$0
MT	medium tone	+\$0
SG	slate grey	+\$0
WL	sandstone	+\$0
WN	warm grey neutral	+\$0

Step 11. Grommets		
NTG	no grommet	+\$0
L	grommet left	+\$27
C	grommet center	+\$27
R	grommet right	+\$27
2LC	grommets left and center	+\$53
2CR	grommets center and right	+\$53
2LR	grommets left and right	+\$53
3LCR	grommets left, center, and right	+\$79

Step 12. Grommet Finish		
<i>For grommet left (L), grommet center (C), grommet right (R), grommets left and center (2LC), grommets center and right (2CR), grommets left and right (2LR), or grommets left, center, and right (3LCR)</i>		
8Q	folkstone grey	+\$0
91	white	+\$0
BU	black umber	+\$0
CL	cool grey neutral	+\$0
HF	inner tone light	+\$0
LU	soft white	+\$0
MT	medium tone	+\$0
SG	slate grey	+\$0
WL	sandstone	+\$0
WN	warm grey neutral	+\$0

Curved Corner Desk with P-Shaped Peninsula

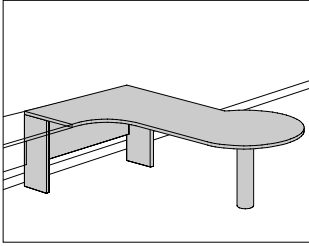

Product Information

Description

This 90° corner P-shaped peninsula desk connects to a 5000 Series component or stands alone. It has a laminate top and vinyl edge or a veneer top and edge and is available with or without grommets. The desk has a curved work surface, a column base, full or 10"-deep recessed end panels, and 1" adjustable glides. The desk with recessed end panels has a cable management cutout at the back of the panel. The desk is available with a full, raised, or open back panel. The full back panel extends to the floor; the raised back panel is 8 1/8" from the floor and provides access to electrical components in panel system raceways; the open back panel is used against architectural walls and provides maximum access to electrical/data outlets, including those complying with ADA standards. The open back panel includes a horizontal support rail; the bottom of the support rail is 8 1/8" from the floor.

Notes

Order optional desk components separately:

- Bridge
- Return shell
- Return with single pedestal

To manage cables under peninsula desk, order cable management trough separately.

Order optional display or storage components separately:

- Desk-mounted tackboard
- Desk-mounted tool rail with tackboard
- End-mounted tackboard
- Flipper door unit

For accessory product applications, the following Compatibility Charts are available electronically for viewing and printing in Kiosk and HermanMiller.com: Keyboard Compatibility Charts, Pencil Drawer Compatibility Charts, and Work Organizer Compatibility Chart.

Dimensions

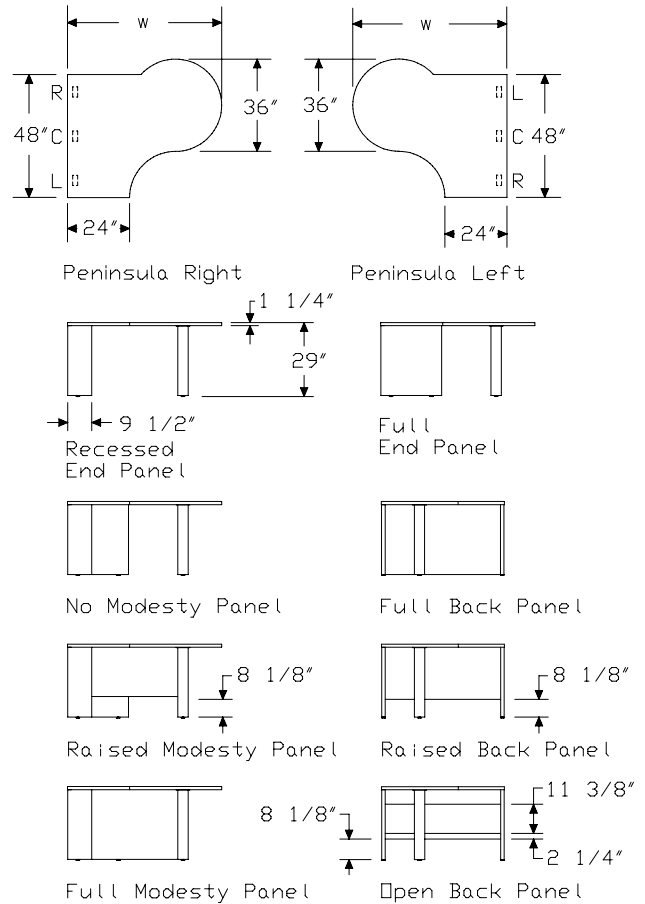

Curved Corner Desk with P- Shaped Peninsula *continued*

Specification Information	
Step 1.	
5	
Step 2. Back Panel	
F0-	full back panel \$0
R0-	raised back panel \$0
P0-	open back panel \$0
Step 3. Width/Position (from User Side)	
486024-P	60"-wide peninsula right +\$1553
486624-P	66"-wide peninsula right +\$1604
487224-P	72"-wide peninsula right +\$1657
604824-P	60"-wide peninsula left +\$1553
664824-P	66"-wide peninsula left +\$1604
724824-P	72"-wide peninsula left +\$1657
Step 4. End Panels (from User Side)	
SS	recessed end panel left, recessed end panel right +\$0
SL	recessed end panel left, full end panel right +\$0
LS	full end panel left, recessed end panel right +\$0
LL	full end panel left, full end panel right +\$0
Step 5. Modesty Panel	
<i>For full back panel (Fo-)</i>	
NP	no modesty panel +\$0
MP	full modesty panel +\$187
<i>For raised back panel (Ro-) or open back panel (Po-)</i>	
NP	no modesty panel +\$0
SP	raised modesty panel +\$164
Step 6. Steel Type	
SS	smooth paint on smooth steel +\$0
TS	smooth paint on textured steel +\$0
Step 7. Understructure Finish	
<i>See Finish Colors list for paint codes.</i>	
Nonmetallic Paint	+\$0
Metallic Paint	+\$40

Step 8. Top		486024-P	486624-P	487224-P	604824-P
NT	disposable top	-\$37	-37	-37	-37
TL	laminate top with vinyl edge	+\$0	0	0	0
TR	recut veneer top A	+\$593	618	642	593
TF	wood veneer top A	+\$700	707	713	700
		664824-P	724824-P		
NT	disposable top		-\$37	-37	
TL	laminate top with vinyl edge		+\$0	0	
TR	recut veneer top A		+\$618	642	
TF	wood veneer top A		+\$707	713	
Step 9.					
Top Finish: Solid-Color Laminate					
<i>For laminate top with vinyl edge (TL)</i>					
8Q	folkstone grey				+\$0
91	white				+\$0
CL	cool grey neutral				+\$0
HF	inner tone light				+\$0
HT	inner tone				+\$0
LT	light tone				+\$0
LU	soft white				+\$0
WL	sandstone				+\$0
WN	warm grey neutral				+\$0
Top Finish: Fiber Laminate					
<i>For laminate top with vinyl edge (TL)</i>					
1X	vanilla				+\$0
2X	wheat				+\$0
3X	celery				+\$0
4X	coriander				+\$0
5X	chamomile				+\$0
6X	cinnamon				+\$0
7X	cardamom				+\$0
8X	kale				+\$0
Top Finish: Frosted Laminate					
<i>For laminate top with vinyl edge (TL)</i>					
J4	frosted light grey				+\$0
J5	frosted inner tone light				+\$0
J6	frosted slate grey				+\$0
J7	frosted medium tone				+\$0
J8	frosted black				+\$0

Curved Corner Desk with P-Shaped Peninsula *continued*

Top Finish: Wood-Grain Laminate

For laminate top with vinyl edge (TL)

LA	light ash	+\$0
LM	mahogany	+\$0

Top/Edge Finish: Recut Veneer

For recut veneer top (TR)

RA	light ash <input type="checkbox"/>	+\$0
RK	mahogany dark <input type="checkbox"/>	+\$0
RM	mahogany <input type="checkbox"/>	+\$0

Top/Edge Finish: Wood Veneer

For wood veneer top (TF)

V3	cherry <input type="checkbox"/>	+\$0
Z3	warm red cherry <input type="checkbox"/>	+\$0
Z5	maple <input type="checkbox"/>	+\$0
ED	aged cherry <input type="checkbox"/>	+\$50
EG	medium brown walnut <input type="checkbox"/>	+\$50
EK	medium red walnut <input type="checkbox"/>	+\$50
EY	light anigre <input type="checkbox"/>	+\$50
UL	natural maple <input type="checkbox"/>	+\$50
UQ	light cherry <input type="checkbox"/>	+\$50
UV	red cherry <input type="checkbox"/>	+\$50
UX	walnut on cherry <input type="checkbox"/>	+\$50

Step 10. Edge Finish

For laminate top with vinyl edge (TL)

8Q	folkstone grey	+\$0
91	white	+\$0
BU	black umber	+\$0
CL	cool grey neutral	+\$0
CM	cinnamon	+\$0
CO	chamomile	+\$0
G2	graphite satin	+\$0
HF	inner tone light	+\$0
HT	inner tone	+\$0
LA	light ash	+\$0
LM	mahogany	+\$0
LU	soft white	+\$0
MT	medium tone	+\$0
SG	slate grey	+\$0
WL	sandstone	+\$0
WN	warm grey neutral	+\$0

Step 11. Grommets

NTG	no grommet	+\$0
L	grommet left	+\$27
C	grommet center	+\$27
R	grommet right	+\$27
2LC	grommets left and center	+\$53
2CR	grommets center and right	+\$53
2LR	grommets left and right	+\$53
3LCR	grommets left, center, and right	+\$79

Step 12. Grommet Finish

For grommet left (L), grommet center (C), grommet right (R), grommets left and center (2LC), grommets center and right (2CR), grommets left and right (2LR), or grommets left, center, and right (3LCR)

8Q	folkstone grey	+\$0
91	white	+\$0
BU	black umber	+\$0
CL	cool grey neutral	+\$0
HF	inner tone light	+\$0
LU	soft white	+\$0
MT	medium tone	+\$0
SG	slate grey	+\$0
WL	sandstone	+\$0
WN	warm grey neutral	+\$0

Extended Curved Corner Desk Shell

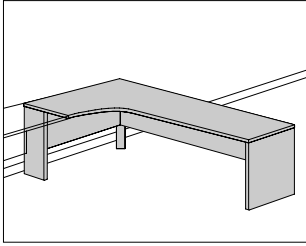

Product Information

Description

This extended 90° corner desk connects to a 5000 Series component or stands alone. It has a laminate top and vinyl edge or a veneer top and edge and is available with or without grommets. The desk has a right- or left-hand extension, 2 full end panels or 1 full end panel and 1 10"-deep recessed end panel, and 1" adjustable glides. 24"-deep desks with recessed end panels have a cable management cutout at the back of the panel. The desk is available with a full, raised, or open back panel. The full back panel extends to the floor; the raised back panel is 8 1/8" from the floor and provides access to electrical components in panel system raceways; the open back panel is used against architectural walls or panel systems and provides maximum access to electrical/data outlets, including those complying with ADA standards. The open back panel includes a horizontal support rail; the bottom of the support rail is 8 1/8" from the floor.

Notes

Full end panel is required on extended end of desk; desk cannot connect to a return or bridge at extended end.

Order optional desk components separately:

- Bridge
- Return shell
- Return with single pedestal

To manage cables under extended curved corner desk, order cable management trough separately.

Order optional display or storage components separately:

- Desk-mounted tackboard
- Desk-mounted tool rail with tackboard
- End-mounted tackboard
- Flipper door unit

For accessory product applications, the following Compatibility Charts are available electronically for viewing and printing in Kiosk and HermanMiller.com: Keyboard Compatibility Charts, Pencil Drawer Compatibility Charts, and Work Organizer Compatibility Chart.

Dimensions

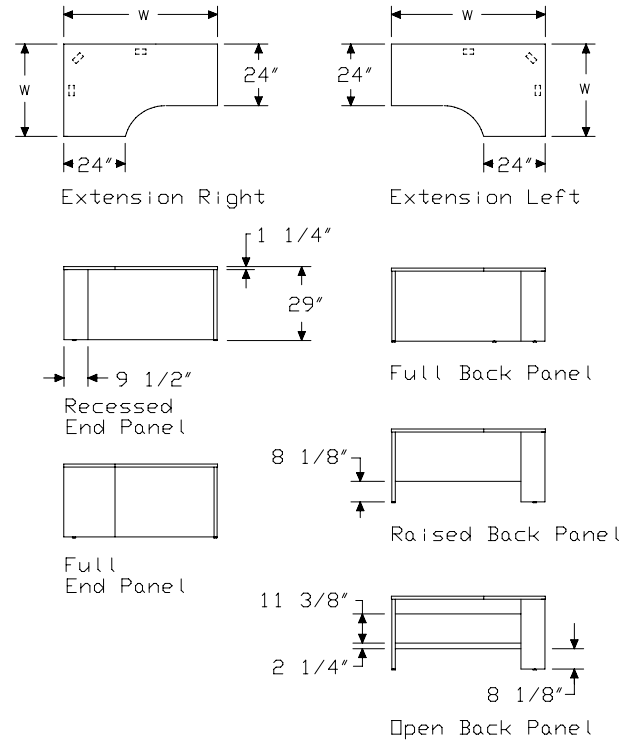

Extended Curved Corner Desk

Shell *continued*

Specification Information

Step 1.

5

Step 2. Back Panel

F0-	full back panel	\$0
R0-	raised back panel	\$0
P0-	open back panel	\$0

Step 3. Left Width (from User Side)

42	42" wide left	+\$0
48	48" wide left	+\$0
60	60"-wide extension left	+\$0
66	66"-wide extension left	+\$0
72	72"-wide extension left	+\$0

Step 4. Right Width (from User Side)

For 42" wide left (42)

6024-C	60"-wide extension right	+\$1278
6624-C	66"-wide extension right	+\$1336
7224-C	72"-wide extension right	+\$1392

For 48" wide left (48)

6024-C	60"-wide extension right	+\$1339
6624-C	66"-wide extension right	+\$1390
7224-C	72"-wide extension right	+\$1452

For 60"-wide extension left (60)

4224-C	42" wide right	+\$1278
4824-C	48" wide right	+\$1339

For 66"-wide extension left (66)

4224-C	42" wide right	+\$1336
4824-C	48" wide right	+\$1390

For 72"-wide extension left (72)

4224-C	42" wide right	+\$1392
4824-C	48" wide right	+\$1452

Step 5. End Panels (from User Side)

For 42" wide left (42) or 48" wide left (48)

SL	recessed end panel left, full end panel right	+\$0
LL	full end panel left, full end panel right	+\$0

For 60"-wide extension left (60), 66"-wide extension left (66), or 72"-wide extension left (72)

LS	full end panel left, recessed end panel right	+\$0
LL	full end panel left, full end panel right	+\$0

Step 6. Steel Type

SS	smooth paint on smooth steel	+\$0
TS	smooth paint on textured steel	+\$0

Step 7. Understructure Finish

See Finish Colors list for paint codes.

Nonmetallic Paint	+\$0
Metallic Paint	+\$70

Step 8. Top

		426024-C	426624-C	427224-C	486024-C
NT	disposable top	-\$37	-37	-37	-37
TL	laminate top with vinyl edge	+\$0	0	0	0
TR	recut veneer top A	+\$541	545	549	593
TF	wood veneer top A	+\$637	642	647	701
		486624-C	487224-C	604224-C	604824-C
NT	disposable top	-\$37	-37	-37	-37
TL	laminate top with vinyl edge	+\$0	0	0	0
TR	recut veneer top A	+\$598	605	541	593
TF	wood veneer top A	+\$707	713	637	701
		664224-C	664824-C	724224-C	724824-C
NT	disposable top	-\$37	-37	-37	-37
TL	laminate top with vinyl edge	+\$0	0	0	0
TR	recut veneer top A	+\$545	598	549	605
TF	wood veneer top A	+\$642	707	647	713

Step 9.

Top Finish: Solid-Color Laminate

For laminate top with vinyl edge (TL)

8Q	folkstone grey	+\$0
91	white	+\$0
CL	cool grey neutral	+\$0
HF	inner tone light	+\$0
HT	inner tone	+\$0
LT	light tone	+\$0
LU	soft white	+\$0
WL	sandstone	+\$0
WN	warm grey neutral	+\$0

Extended Curved Corner Desk

Shell *continued*

Top Finish: Fiber Laminate		
<i>For laminate top with vinyl edge (TL)</i>		
1X	vanilla	+\$0
2X	wheat	+\$0
3X	celery	+\$0
4X	coriander	+\$0
5X	chamomile	+\$0
6X	cinnamon	+\$0
7X	cardamom	+\$0
8X	kale	+\$0

Top Finish: Frosted Laminate		
<i>For laminate top with vinyl edge (TL)</i>		
J4	frosted light grey	+\$0
J5	frosted inner tone light	+\$0
J6	frosted slate grey	+\$0
J7	frosted medium tone	+\$0
J8	frosted black	+\$0

Top Finish: Wood-Grain Laminate		
<i>For laminate top with vinyl edge (TL)</i>		
LA	light ash	+\$0
LM	mahogany	+\$0

Top/Edge Finish: Recut Veneer		
<i>For recut veneer top (TR)</i>		
RA	light ash A	+\$0
RK	mahogany dark A	+\$0
RM	mahogany A	+\$0

Top/Edge Finish: Wood Veneer		
<i>For wood veneer top (TF)</i>		
V3	cherry A	+\$0
Z3	warm red cherry A	+\$0
Z5	maple A	+\$0
ED	aged cherry A	+\$50
EG	medium brown walnut A	+\$50
EK	medium red walnut A	+\$50
EY	light anigre A	+\$50
UL	natural maple A	+\$50
UQ	light cherry A	+\$50
UV	red cherry A	+\$50
UX	walnut on cherry A	+\$50

Step 10. Edge Finish		
<i>For laminate top with vinyl edge (TL)</i>		
8Q	folkstone grey	+\$0
91	white	+\$0
BU	black umber	+\$0
CL	cool grey neutral	+\$0
CM	cinnamon	+\$0
CO	chamomile	+\$0
G2	graphite satin	+\$0
HF	inner tone light	+\$0
HT	inner tone	+\$0
LA	light ash	+\$0
LM	mahogany	+\$0
LU	soft white	+\$0
MT	medium tone	+\$0
SG	slate grey	+\$0
WL	sandstone	+\$0
WN	warm grey neutral	+\$0

Step 11. Grommets		
NTG	no grommet	+\$0
L	grommet left	+\$27
C	grommet center	+\$27
R	grommet right	+\$27
2LC	grommets left and center	+\$53
2CR	grommets center and right	+\$53
2LR	grommets left and right	+\$53
3LCR	grommets left, center, and right	+\$79

Step 12. Grommet Finish		
<i>For grommet left (L), grommet center (C), grommet right (R), grommets left and center (2LC), grommets center and right (2CR), grommets left and right (2LR), or grommets left, center, and right (3LCR)</i>		
8Q	folkstone grey	+\$0
91	white	+\$0
BU	black umber	+\$0
CL	cool grey neutral	+\$0
HF	inner tone light	+\$0
LU	soft white	+\$0
MT	medium tone	+\$0
SG	slate grey	+\$0
WL	sandstone	+\$0
WN	warm grey neutral	+\$0

Extended Curved Corner Desk with Single Pedestal

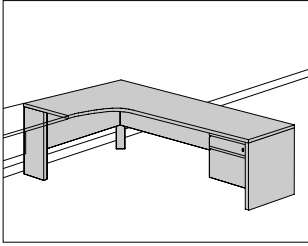

Product Information

Description

This extended 90° corner desk connects to a 5000 Series component or stands alone. It has a right- or left-hand extension, 2 full end panels or 1 full end panel and 1 10"-deep recessed end panel, and 1" adjustable glides. The extended corner desk has 1 lockable pedestal and a choice of pull and front styles (see chart below). Box drawers have 1 drawer divider. B- and F-pull file drawers hold letter-size front-to-back hanging files; they also include 2 file converters for legal-size filing. Standard-, contour-, and bevel-pull file drawers include 1 file compressor for letter-size front-to-back or side-to-side hanging files or legal-size side-to-side hanging files. File drawers have full-extension steel ball-bearing slides. The desk has a laminate top and vinyl edge or a veneer top and edge and is available with or without grommets. 24"-deep desks with recessed end panels have a cable management cutout at the back of the panel. The desk is available with a full, raised, or open back panel. The full back panel extends to the floor; the raised back panel is 8¹/₈" from the floor and provides access to electrical components in panel system raceways; the open back panel is used against architectural walls or panel systems and provides maximum access to electrical/data outlets, including those complying with ADA standards. The open back panel includes a horizontal support rail; the bottom of the support rail is 8¹/₈" from the floor.

Pull Style—Pull Material—Front Style

Standard—Metal pull—Wood Veneer front

Standard—Metal pull—Recut Veneer front

Standard—Metal pull—Metal front

Bevel—Metal pull—Metal front

Contour—Aluminum or Wood pull—Metal front

F-pull—Plastic pull—Metal front

B-pull—Plastic pull—Plastic front

Notes

Full end panel support is required on extended end of desk; desk cannot connect to a return or bridge at extended end.

Pedestal must mount on extended end of desk.

B- and F-pull pedestals have a smooth-steel case.

Box/box/file and file/file pedestal combinations with standard, contour, or bevel pulls hang 3³/₄" below raised back panel; box/box/file and file/file pedestal combinations with B and F pulls hang 6" below raised back panel.

Pedestals with standard, bevel, and contour pulls are 3⁷/₈" wider than pedestals with B and F pulls. Drawer accessories for pedestals with standard, bevel, and contour pulls are not interchangeable with accessories for pedestals with B and F pulls.

Order optional desk components separately:

- Bridge
- Return shell
- Return with single pedestal

To manage cables under extended curved corner desk, order cable management trough separately.

Order optional display or storage components separately:

- Desk-mounted tackboard
- Desk-mounted tool rail with tackboard
- End-mounted tackboard
- Flipper door unit

For accessory product applications, the following Compatibility Charts are available electronically for viewing and printing in Kiosk and HermanMiller.com: Keyboard Compatibility Charts, Pencil Drawer Compatibility Charts, and Work Organizer Compatibility Chart.

Pedestal ships with lock plugs keyed differently (KD). For keyed-alike locks on multiple pedestals, specify keyed alike (KA); separate lock plugs are shipped and field installed on each pedestal. See Keyed-Alike Information in Appendices.

Extended Curved Corner Desk with Single Pedestal *continued*

Dimensions

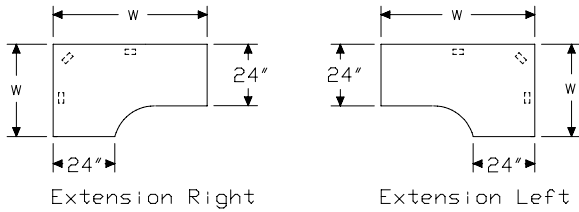

Extension Right

Extension Left

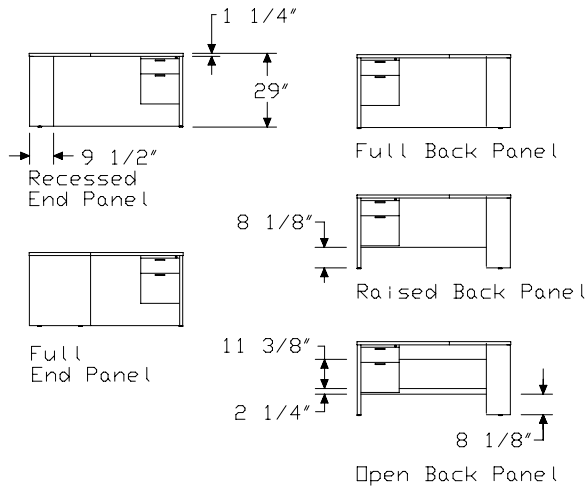

Full Back Panel

Raised Back Panel

Open Back Panel

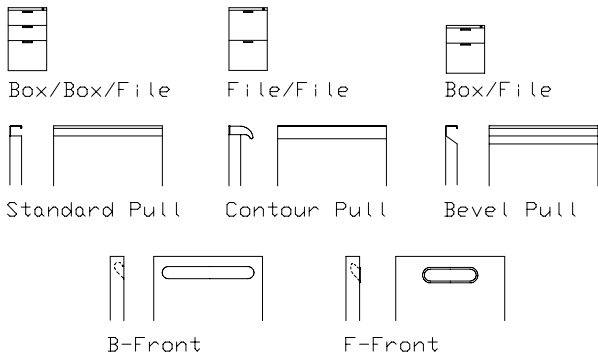

Box/Box/File

File/File

Box/File

Standard Pull

Contour Pull

Bevel Pull

B-Front

F-Front

Specification Information

Step 1.

5

Step 2. Back Panel

F	full back panel	\$0
R	raised back panel	\$0
P	open back panel	\$0

Step 3. Pedestal Pull/Front Style

6-	standard pull with painted front	+\$171
R-	standard pull with recut veneer front A	+\$456
F-	standard pull with wood veneer front A	+\$482
5-	contour pull	+\$300
4-	bevel pull	+\$171
X-	B-pull	+\$146
Y-	F-pull	+\$118

Step 4. Left Width (from User Side)

42	42" wide left	+\$0
48	48" wide left	+\$0
60	60"-wide extension left	+\$0
66	66"-wide extension left	+\$0
72	72"-wide extension left	+\$0

Step 5. Right Width (from User Side)

For 42" wide left (42)

6024-C	60"-wide extension right	+\$1350
6624-C	66"-wide extension right	+\$1402
7224-C	72"-wide extension right	+\$1455

For 48" wide left (48)

6024-C	60"-wide extension right	+\$1402
6624-C	66"-wide extension right	+\$1455
7224-C	72"-wide extension right	+\$1522

For 60"-wide extension left (60)

4224-C	42" wide right	+\$1350
4824-C	48" wide right	+\$1402

For 66"-wide extension left (66)

4224-C	42" wide right	+\$1402
4824-C	48" wide right	+\$1455

Extended Curved Corner Desk with Single Pedestal *continued*

<i>For 72"-wide extension left (72)</i>		
4224-C	42" wide right	+\$1455
4824-C	48" wide right	+\$1522

Step 6. Configuration (from User Side)

<i>For 42" wide left (42) or 48" wide left (48)</i>		
SH	recessed end panel left, box/box/file right	+\$288
SG	recessed end panel left, file/file right	+\$249
SA	recessed end panel left, box/file right	+\$132
LH	full end panel left, box/box/file right	+\$288
LG	full end panel left, file/file right	+\$249
LA	full end panel left, box/file right	+\$132

For 60"-wide extension left (60), 66"-wide extension left (66), or 72"-wide extension left (72)

HS	box/box/file left, recessed end panel right	+\$288
HL	box/box/file left, full end panel right	+\$288
GS	file/file left, recessed end panel right	+\$249
GL	file/file left, full end panel right	+\$249
AS	box/file left, recessed end panel right	+\$132
AL	box/file left, full end panel right	+\$132

Step 7. Steel Type

For standard pull with painted front (6-), standard pull with recut veneer front (R-), standard pull with wood veneer front (F-), contour pull (5-), or bevel pull (4-)

SS	smooth paint on smooth steel	+\$0
TS	smooth paint on textured steel	+\$0

For B-pull (X-) or F-pull (Y-)

SS	smooth paint on smooth steel	+\$0
-----------	------------------------------	------

Step 8. Understructure Finish

See Finish Colors list for paint codes.

For standard pull with painted front (6-), standard pull with recut veneer front (R-), standard pull with wood veneer front (F-), contour pull (5-), or bevel pull (4-)

Nonmetallic Paint	+\$0
Metallic Paint	+\$110

For B-pull (X-)

8Q	folkstone grey	+\$0
BU	black umber	+\$0
HF	inner tone light	+\$0
LT	light tone	+\$0
LU	soft white	+\$0
MT	medium tone	+\$0
SG	slate grey	+\$0
WL	sandstone	+\$0

For F-pull (Y-)

8Q	folkstone grey	+\$0
BU	black umber	+\$0
HF	inner tone light	+\$0
LT	light tone	+\$0
LU	soft white	+\$0
MT	medium tone	+\$0
SG	slate grey	+\$0
WL	sandstone	+\$0
CN	metallic champagne	+\$110
EH	metallic bronze	+\$110
MS	metallic silver	+\$110

Step 9. Pull Type

For contour pull (5-)

1P	painted	+\$0
1S	stained <input type="checkbox"/>	+\$0

Step 10. Pull Finish

See Finish Colors list for paint codes.

For painted (1P)

Nonmetallic Paint	+\$0
Metallic Paint	+\$0

Extended Curved Corner Desk with Single Pedestal *continued*

Solid Woods		
<i>For stained (1S)</i>		
V3	cherry A	+\$0
Z3	warm red cherry A	+\$0
Z5	maple A	+\$0
ED	aged cherry A	+\$10
EG	medium brown walnut A	+\$10
EK	medium red walnut A	+\$10
EY	light anigre A	+\$10
UL	natural maple A	+\$10
UQ	light cherry A	+\$10
UV	red cherry A	+\$10
UX	walnut on cherry A	+\$10

Step 11. Top

For standard pull with painted front (6-), contour pull (5-), bevel pull (4-), B-pull (X-), or F-pull (Y-)

	426024-C	426624-C	427224-C	486024-C
NT	disposable top	-\$37	-37	-37
TL	laminate top with vinyl edge	+\$0	0	0
TR	recut veneer top A	+\$541	545	549
TF	wood veneer top A	+\$637	642	647

	486624-C	487224-C	604224-C	604824-C
NT	disposable top	-\$37	-37	-37
TL	laminate top with vinyl edge	+\$0	0	0
TR	recut veneer top A	+\$598	605	541
TF	wood veneer top A	+\$707	713	637

	664224-C	664824-C	724224-C	724824-C
NT	disposable top	-\$37	-37	-37
TL	laminate top with vinyl edge	+\$0	0	0
TR	recut veneer top A	+\$545	598	549
TF	wood veneer top A	+\$642	707	647

For standard pull with recut veneer front (R-)

	426024-C	426624-C	427224-C	486024-C
TR	recut veneer top A	+\$541	545	549

	486624-C	487224-C	604224-C	604824-C
TR	recut veneer top A	+\$598	605	541

	664224-C	664824-C	724224-C	724824-C
TR	recut veneer top A	+\$545	598	549

For standard pull with wood veneer front (F-)

	426024-C	426624-C	427224-C	486024-C
TF	wood veneer top A	+\$637	642	647

	486624-C	487224-C	604224-C	604824-C
TF	wood veneer top A	+\$707	713	637

		664224-C	664824-C	724224-C	724824-C
TF	wood veneer top A	+\$642	707	647	713

Step 12.

Top Finish: Solid-Color Laminate

For laminate top with vinyl edge (TL)

8Q	folkstone grey	+\$0
91	white	+\$0
CL	cool grey neutral	+\$0
HF	inner tone light	+\$0
HT	inner tone	+\$0
LT	light tone	+\$0
LU	soft white	+\$0
WL	sandstone	+\$0
WN	warm grey neutral	+\$0

Top Finish: Fiber Laminate

For laminate top with vinyl edge (TL)

1X	vanilla	+\$0
2X	wheat	+\$0
3X	celery	+\$0
4X	coriander	+\$0
5X	chamomile	+\$0
6X	cinnamon	+\$0
7X	cardamom	+\$0
8X	kale	+\$0

Top Finish: Frosted Laminate

For laminate top with vinyl edge (TL)

J4	frosted light grey	+\$0
J5	frosted inner tone light	+\$0
J6	frosted slate grey	+\$0
J7	frosted medium tone	+\$0
J8	frosted black	+\$0

Top Finish: Wood-Grain Laminate

For laminate top with vinyl edge (TL)

LA	light ash	+\$0
LM	mahogany	+\$0

Top/Edge Finish: Recut Veneer

For standard pull with painted front (6-), contour pull (5-), bevel pull (4-), B-pull (X-), or F-pull (Y-) with recut veneer top (TR)

RA	light ash A	+\$0
RK	mahogany dark A	+\$0
RM	mahogany A	+\$0

Extended Curved Corner Desk with Single Pedestal *continued*

Top/Edge Finish: Wood Veneer

For standard pull with painted front (6-), bevel pull (4-), B-pull (X-), or F-pull (Y-) with wood veneer top (TF)

V3	cherry A	+\$0
Z3	warm red cherry A	+\$0
Z5	maple A	+\$0
ED	aged cherry A	+\$50
EG	medium brown walnut A	+\$50
EK	medium red walnut A	+\$50
EY	light anigre A	+\$50
UL	natural maple A	+\$50
UQ	light cherry A	+\$50
UV	red cherry A	+\$50
UX	walnut on cherry A	+\$50

Front/Top/Edge Finish: Recut Veneer

For standard pull with recut veneer front (R-) with recut veneer top (TR)

RA	light ash A	+\$0
RK	mahogany dark A	+\$0
RM	mahogany A	+\$0

Front/Top/Edge Finish: Wood Veneer

For standard pull with wood veneer front (F-) with wood veneer top (TF)

V3	cherry A	+\$0
Z3	warm red cherry A	+\$0
Z5	maple A	+\$0
ED	aged cherry A	+\$35
EG	medium brown walnut A	+\$35
EK	medium red walnut A	+\$35
EY	light anigre A	+\$35
UL	natural maple A	+\$35
UQ	light cherry A	+\$35
UV	red cherry A	+\$35
UX	walnut on cherry A	+\$35

Top/Edge Finish: Wood Veneer

For contour pull (5-) with wood veneer top (TF)

V3	cherry A	+\$0
Z3	warm red cherry A	+\$0
Z5	maple A	+\$0

Step 13. Edge Finish

For laminate top with vinyl edge (TL)

8Q	folkstone grey	+\$0
91	white	+\$0
BU	black umber	+\$0
CL	cool grey neutral	+\$0
CM	cinnamon	+\$0
CO	chamomile	+\$0
G2	graphite satin	+\$0
HF	inner tone light	+\$0
HT	inner tone	+\$0
LA	light ash	+\$0
LM	mahogany	+\$0
LU	soft white	+\$0
MT	medium tone	+\$0
SG	slate grey	+\$0
WL	sandstone	+\$0
WN	warm grey neutral	+\$0

Step 14. Grommets

NTG	no grommet	+\$0
L	grommet left	+\$27
C	grommet center	+\$27
R	grommet right	+\$27
2LC	grommets left and center	+\$53
2CR	grommets center and right	+\$53
2LR	grommets left and right	+\$53
3LCR	grommets left, center, and right	+\$79

Step 15. Grommet Finish

For grommet left (L), grommet center (C), grommet right (R), grommets left and center (2LC), grommets center and right (2CR), grommets left and right (2LR), or grommets left, center, and right (3LCR)

8Q	folkstone grey	+\$0
91	white	+\$0
BU	black umber	+\$0
CL	cool grey neutral	+\$0
HF	inner tone light	+\$0
LU	soft white	+\$0
MT	medium tone	+\$0
SG	slate grey	+\$0
WL	sandstone	+\$0
WN	warm grey neutral	+\$0

Extended Curved Corner Desk with Single Pedestal *continued*

Step 16. Lock

For standard pull with painted front (6-), standard pull with recut veneer front (R-), standard pull with wood veneer front (F-), contour pull (5-), or bevel pull (4-)

KD	keyed differently with black lock	+\$0
KC	keyed differently with chrome lock	+\$0
KA	keyed alike	+\$0

For B-pull (X-) or F-pull (Y-)

KD	keyed differently with black lock	+\$0
KA	keyed alike	+\$0

D-Shaped Peninsula

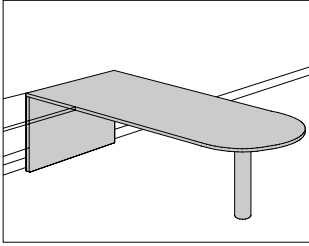

Product Information

Description

This D-shaped peninsula attaches to the side or end of a 5000 Series desk component. It has a laminate top and vinyl edge or a veneer top and edge and a column base. The side-attaching peninsula includes a full end panel and is available with or without grommets. Attachment hardware is included.

Notes

Order optional desk components separately:

- Desk shell
- Desk with single pedestal
- Return shell
- Return with single pedestal

To manage cables under peninsula, order cable management trough separately.

Order optional flipper door unit separately.

For accessory product applications, the following Compatibility Charts are available electronically for viewing and printing in Kiosk and HermanMiller.com: Keyboard Compatibility Charts, Pencil Drawer Compatibility Charts, and Work Organizer Compatibility Chart.

Dimensions

End Attaching

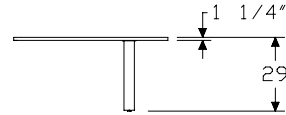
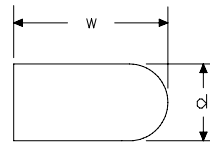

Side Attaching

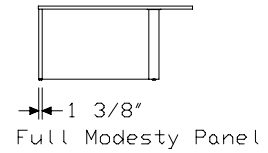
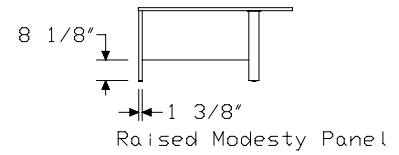
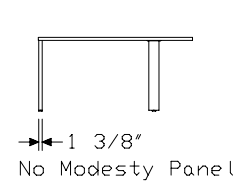
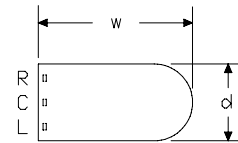

Specification Information		
Step 1.		
5-		
Step 2. Width		
48	48" wide	\$0
60	60" wide	\$0
66	66" wide	\$0
72	72" wide	\$0
Step 3. Depth		
<i>For 48" wide (48)</i>		
30-	30" deep	+\$845
<i>For 60" wide (60)</i>		
30-	30" deep	+\$880
36-	36" deep	+\$908
<i>For 66" wide (66)</i>		
30-	30" deep	+\$934
36-	36" deep	+\$973
<i>For 72" wide (72)</i>		
30-	30" deep	+\$939
36-	36" deep	+\$975
Step 4. Attachment		
ED	end attaching	+\$0
SD	side attaching	+\$172
Step 5. Modesty Panel		
<i>For side attaching (SD)</i>		
NP	no modesty panel	+\$0
SP	raised modesty panel	+\$164
MP	full modesty panel	+\$187
Step 6. Steel Type		
<i>For end attaching (ED)</i>		
SS	smooth paint on smooth steel	+\$0
<i>For side attaching (SD)</i>		
SS	smooth paint on smooth steel	+\$0
TS	smooth paint on textured steel	+\$0

Step 7. Understructure Finish					
<i>See Finish Colors list for paint codes.</i>					
		ED	SD		
Nonmetallic Paint		+\$0	0		
Metallic Paint		+\$15	40		
Step 8. Top					
		48	60	66	72
NT	disposable top	-\$37	-37	-37	-37
TL	laminate top with vinyl edge	+\$0	0	0	0
TR	recut veneer top A	+\$301	336	368	402
TF	wood veneer top A	+\$332	368	407	440
Step 9.					
Top Finish: Solid-Color Laminate					
<i>For laminate top with vinyl edge (TL)</i>					
8Q	folkstone grey			+\$0	
91	white			+\$0	
CL	cool grey neutral			+\$0	
HF	inner tone light			+\$0	
HT	inner tone			+\$0	
LT	light tone			+\$0	
LU	soft white			+\$0	
WL	sandstone			+\$0	
WN	warm grey neutral			+\$0	
Top Finish: Fiber Laminate					
<i>For laminate top with vinyl edge (TL)</i>					
1X	vanilla			+\$0	
2X	wheat			+\$0	
3X	celery			+\$0	
4X	coriander			+\$0	
5X	chamomile			+\$0	
6X	cinnamon			+\$0	
7X	cardamom			+\$0	
8X	kale			+\$0	
Top Finish: Frosted Laminate					
<i>For laminate top with vinyl edge (TL)</i>					
J4	frosted light grey			+\$0	
J5	frosted inner tone light			+\$0	
J6	frosted slate grey			+\$0	
J7	frosted medium tone			+\$0	
J8	frosted black			+\$0	

Top Finish: Wood-Grain Laminate

For laminate top with vinyl edge (TL)

LA	light ash	+\$0
LM	mahogany	+\$0

Top/Edge Finish: Recut Veneer

For recut veneer top (TR)

RA	light ash A	+\$0
RK	mahogany dark A	+\$0
RM	mahogany A	+\$0

Top/Edge Finish: Wood Veneer

For wood veneer top (TF)

V3	cherry A	+\$0
Z3	warm red cherry A	+\$0
Z5	maple A	+\$0
ED	aged cherry A	+\$30
EG	medium brown walnut A	+\$30
EK	medium red walnut A	+\$30
EY	light anigre A	+\$30
UL	natural maple A	+\$30
UQ	light cherry A	+\$30
UV	red cherry A	+\$30
UX	walnut on cherry A	+\$30

Step 10. Edge Finish

For laminate top with vinyl edge (TL)

8Q	folkstone grey	+\$0
91	white	+\$0
BU	black umber	+\$0
CL	cool grey neutral	+\$0
CM	cinnamon	+\$0
CO	chamomile	+\$0
G2	graphite satin	+\$0
HF	inner tone light	+\$0
HT	inner tone	+\$0
LA	light ash	+\$0
LM	mahogany	+\$0
LU	soft white	+\$0
MT	medium tone	+\$0
SG	slate grey	+\$0
WL	sandstone	+\$0
WN	warm grey neutral	+\$0

Step 11. Grommets

For side attaching (SD) with no modesty panel (NP)

NTG	no grommet	+\$0
L	grommet left	+\$27
C	grommet center	+\$27
R	grommet right	+\$27
2LC	grommets left and center	+\$53
2CR	grommets center and right	+\$53
2LR	grommets left and right	+\$53
3LCR	grommets left, center, and right	+\$79

For side attaching (SD) with raised modesty panel (SP) or full modesty panel (MP)

NTG	no grommet	+\$0
L	grommet left	+\$27
R	grommet right	+\$27
2LR	grommets left and right	+\$53

Step 12. Grommet Finish

For grommet left (L), grommet center (C), grommet right (R), grommets left and center (2LC), grommets center and right (2CR), grommets left and right (2LR), or grommets left, center, and right (3LCR)

8Q	folkstone grey	+\$0
91	white	+\$0
BU	black umber	+\$0
CL	cool grey neutral	+\$0
HF	inner tone light	+\$0
LU	soft white	+\$0
MT	medium tone	+\$0
SG	slate grey	+\$0
WL	sandstone	+\$0
WN	warm grey neutral	+\$0

P-Shaped Peninsula

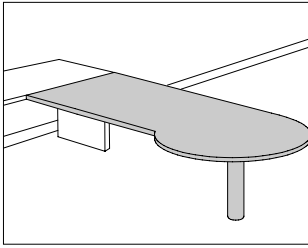

Product Information

Description

This P-shaped peninsula attaches to the side or end of a 5000 Series desk component. It has a laminate top and vinyl edge or a veneer top and edge and a column base. The side-attaching peninsula includes a full end panel and is available with or without grommets. Attachment hardware is included.

Notes

Order optional desk components separately:

- Desk shell
- Desk with single pedestal
- Return shell
- Return with single pedestal

To manage cables under peninsula, order cable management trough separately.

Order optional flipper door unit separately.

For accessory product applications, the following Compatibility Charts are available electronically for viewing and printing in Kiosk and HermanMiller.com: Keyboard Compatibility Charts, Pencil Drawer Compatibility Charts, and Work Organizer Compatibility Chart.

Dimensions

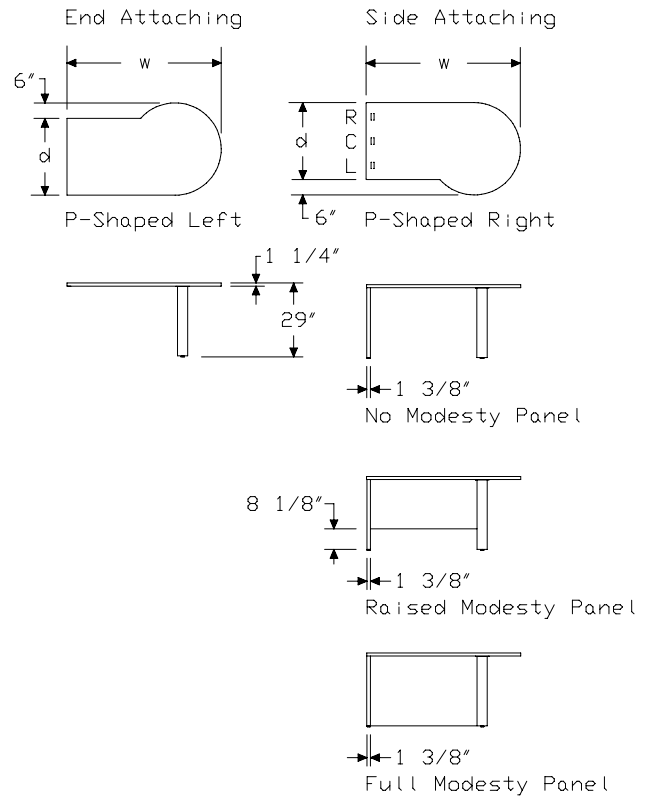

P-Shaped Peninsula *continued*

Specification Information

Step 1.

5-

Step 2. Width

48	48" wide	\$0
60	60" wide	\$0
66	66" wide	\$0
72	72" wide	\$0

Step 3. Depth

For 48" wide (48)

30- 30" deep +\$1028

For 60" wide (60)

30- 30" deep +\$1067

36- 36" deep +\$1123

For 66" wide (66)

30- 30" deep +\$1128

36- 36" deep +\$1196

For 72" wide (72)

30- 30" deep +\$1134

36- 36" deep +\$1204

Step 4. Attachment

EP end attaching +\$0

SP side attaching +\$172

Step 5. Direction

L P-shaped left +\$0

R P-shaped right +\$0

Step 6. Modesty Panel

For side attaching (SP)

NP no modesty panel +\$0

SP raised modesty panel +\$164

MP full modesty panel +\$187

Step 7. Steel Type

For end attaching (EP)

SS smooth paint on smooth steel +\$0

For side attaching (SP)

SS smooth paint on smooth steel +\$0

TS smooth paint on textured steel +\$0

Step 8. Understructure Finish

See *Finish Colors list for paint codes.*

	EP	SP
Nonmetallic Paint	+\$0	0
Metallic Paint	+\$15	40

Step 9. Top

	48	60	66	72
NT disposable top	-\$37	-37	-37	-37
TL laminate top with vinyl edge	+\$0	0	0	0
TR recut veneer top A	+\$361	395	433	469
TF wood veneer top A	+\$395	436	476	515

Step 10.

Top Finish: Solid-Color Laminate

For laminate top with vinyl edge (TL)

8Q folkstone grey	+\$0
91 white	+\$0
CL cool grey neutral	+\$0
HF inner tone light	+\$0
HT inner tone	+\$0
LT light tone	+\$0
LU soft white	+\$0
WL sandstone	+\$0
WN warm grey neutral	+\$0

Top Finish: Fiber Laminate

For laminate top with vinyl edge (TL)

1X vanilla	+\$0
2X wheat	+\$0
3X celery	+\$0
4X coriander	+\$0
5X chamomile	+\$0
6X cinnamon	+\$0
7X cardamom	+\$0
8X kale	+\$0

Top Finish: Frosted Laminate		
<i>For laminate top with vinyl edge (TL)</i>		
J4	frosted light grey	+\$0
J5	frosted inner tone light	+\$0
J6	frosted slate grey	+\$0
J7	frosted medium tone	+\$0
J8	frosted black	+\$0

Top Finish: Wood-Grain Laminate		
<i>For laminate top with vinyl edge (TL)</i>		
LA	light ash	+\$0
LM	mahogany	+\$0

Top/Edge Finish: Recut Veneer		
<i>For recut veneer top (TR)</i>		
RA	light ash <input type="checkbox"/> A	+\$0
RK	mahogany dark <input type="checkbox"/> A	+\$0
RM	mahogany <input type="checkbox"/> A	+\$0

Top/Edge Finish: Wood Veneer		
<i>For wood veneer top (TF)</i>		
V3	cherry <input type="checkbox"/> A	+\$0
Z3	warm red cherry <input type="checkbox"/> A	+\$0
Z5	maple <input type="checkbox"/> A	+\$0
ED	aged cherry <input type="checkbox"/> A	+\$30
EG	medium brown walnut <input type="checkbox"/> A	+\$30
EK	medium red walnut <input type="checkbox"/> A	+\$30
EY	light anigre <input type="checkbox"/> A	+\$30
UL	natural maple <input type="checkbox"/> A	+\$30
UQ	light cherry <input type="checkbox"/> A	+\$30
UV	red cherry <input type="checkbox"/> A	+\$30
UX	walnut on cherry <input type="checkbox"/> A	+\$30

Step 11. Edge Finish		
<i>For laminate top with vinyl edge (TL)</i>		
8Q	folkstone grey	+\$0
91	white	+\$0
BU	black umber	+\$0
CL	cool grey neutral	+\$0
CM	cinnamon	+\$0
CO	chamomile	+\$0
G2	graphite satin	+\$0
HF	inner tone light	+\$0
HT	inner tone	+\$0
LA	light ash	+\$0
LM	mahogany	+\$0
LU	soft white	+\$0
MT	medium tone	+\$0
SG	slate grey	+\$0
WL	sandstone	+\$0
WN	warm grey neutral	+\$0

Step 12. Grommets		
<i>For side attaching (SP) with no modesty panel (NP)</i>		
NTG	no grommet	+\$0
L	grommet left	+\$27
C	grommet center	+\$27
R	grommet right	+\$27
2LC	grommets left and center	+\$53
2CR	grommets center and right	+\$53
2LR	grommets left and right	+\$53
3LCR	grommets left, center, and right	+\$79
<i>For side attaching (SP) with raised modesty panel (SP) or full modesty panel (MP)</i>		
NTG	no grommet	+\$0
L	grommet left	+\$27
R	grommet right	+\$27
2LR	grommets left and right	+\$53

P-Shaped Peninsula *continued*

Step 13. Grommet Finish

For grommet left (L), grommet center (C), grommet right (R), grommets left and center (2LC), grommets center and right (2CR), grommets left and right (2LR), or grommets left, center, and right (3LCR)

8Q	folkstone grey	+\$0
91	white	+\$0
BU	black umber	+\$0
CL	cool grey neutral	+\$0
HF	inner tone light	+\$0
LU	soft white	+\$0
MT	medium tone	+\$0
SG	slate grey	+\$0
WL	sandstone	+\$0
WN	warm grey neutral	+\$0

Return Shell

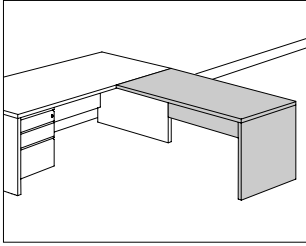

Product Information

Description

This return connects to a 5000 Series desk component for additional workspace. It has a laminate top and vinyl edge or a veneer top and edge and is available with or without grommets. The return has 1 full end panel or 1 10"-deep recessed end panel and 1" adjustable glides. The return with a recessed end panel has a cable management cutout at the back of the panel. Each return has a full, raised, or open back panel. The full back panel extends to the floor; the raised back panel is 8 1/8" from the floor and provides access to electrical components in panel system raceways; the open back panel is used against architectural walls or panel systems and provides maximum access to electrical/data outlets, including those complying with ADA standards. The open back panel includes a horizontal support rail; the bottom of the support rail is 8 1/8" from the floor. Attachment hardware is included.

Notes

Order optional desk components separately:

- Corner desk
- Curved corner desk
- Desk shell
- Desk with single pedestal

To manage cables under return, order cable management trough separately.

Order optional display or storage components separately:

- Desk-mounted tackboard
- Desk-mounted tool rail with tackboard
- End-mounted tackboard
- Flipper door unit

For accessory product applications, the following Compatibility Charts are available electronically for viewing and printing in Kiosk and HermanMiller.com: Keyboard Compatibility Charts, Pencil Drawer Compatibility Charts, and Work Organizer Compatibility Chart.

Dimensions

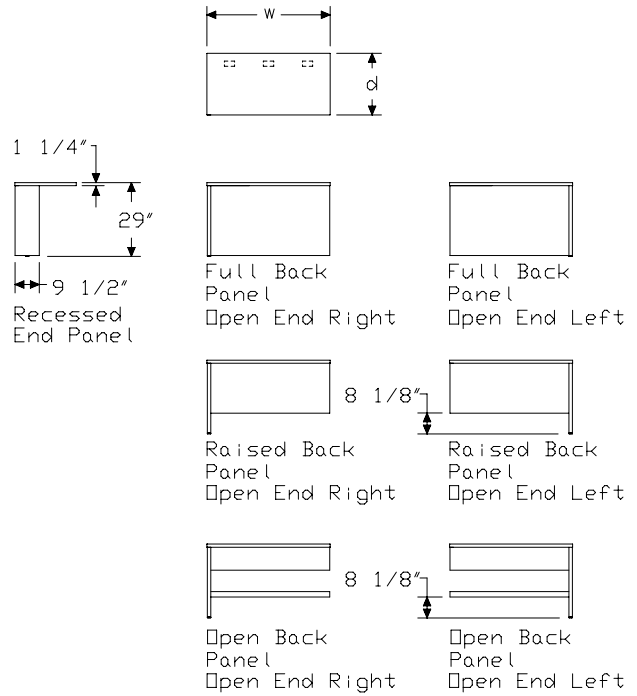

Specification Information

Step 1.

5

Step 2. Back Panel

F0-	full back panel	\$0
R0-	raised back panel	\$0
P0-	open back panel	\$0

Step 3. Width

24	24" wide	+\$0
30	30" wide	+\$0
36	36" wide	+\$0
42	42" wide	+\$0
48	48" wide	+\$0
60	60" wide	+\$0
66	66" wide	+\$0
72	72" wide	+\$0

Step 4. Depth

For 24" wide (24)

20-	20" deep	+\$588
24-	24" deep	+\$603
30-	30" deep	+\$633

For 30" wide (30)

20-	20" deep	+\$603
24-	24" deep	+\$617
30-	30" deep	+\$647

For 36" wide (36)

20-	20" deep	+\$623
24-	24" deep	+\$638
30-	30" deep	+\$669

For 42" wide (42)

20-	20" deep	+\$646
24-	24" deep	+\$659
30-	30" deep	+\$692

For 48" wide (48)

20-	20" deep	+\$666
24-	24" deep	+\$680
30-	30" deep	+\$715

For 60" wide (60)

20-	20" deep	+\$710
24-	24" deep	+\$723
30-	30" deep	+\$761

For 66" wide (66)

20-	20" deep	+\$800
24-	24" deep	+\$816
30-	30" deep	+\$858

For 72" wide (72)

20-	20" deep	+\$842
24-	24" deep	+\$858
30-	30" deep	+\$901

Step 5. End Panel (from User Side)

OSD	open end left, recessed end panel right	+\$0
OLD	open end left, full end panel right	+\$0
SOD	recessed end panel left, open end right	+\$0
LOD	full end panel left, open end right	+\$0

Step 6. Steel Type

SS	smooth paint on smooth steel	+\$0
TS	smooth paint on textured steel	+\$0

Step 7. Understructure Finish

See Finish Colors list for paint codes.

Nonmetallic Paint	+\$0
Metallic Paint	+\$40

Step 8. Top

		24	30	36	42	48
NT	disposable top	-\$37	-37	-37	-37	-37
TL	laminate top with vinyl edge	+\$0	0	0	0	0
TR	recut veneer top A	+\$297	297	313	340	367
TF	wood veneer top A	+\$349	349	368	402	433
			60	66	72	
NT	disposable top		-\$37	-37	-37	
TL	laminate top with vinyl edge		+\$0	0	0	
TR	recut veneer top A		+\$399	412	426	
TF	wood veneer top A		+\$471	486	500	

Step 9.

Top Finish: Solid-Color Laminate
For laminate top with vinyl edge (TL)

8Q	folkstone grey	+\$0
91	white	+\$0
CL	cool grey neutral	+\$0
HF	inner tone light	+\$0
HT	inner tone	+\$0
LT	light tone	+\$0
LU	soft white	+\$0
WL	sandstone	+\$0
WN	warm grey neutral	+\$0

Top Finish: Fiber Laminate
For laminate top with vinyl edge (TL)

1X	vanilla	+\$0
2X	wheat	+\$0
3X	celery	+\$0
4X	coriander	+\$0
5X	chamomile	+\$0
6X	cinnamon	+\$0
7X	cardamom	+\$0
8X	kale	+\$0

Top Finish: Frosted Laminate
For laminate top with vinyl edge (TL)

J4	frosted light grey	+\$0
J5	frosted inner tone light	+\$0
J6	frosted slate grey	+\$0
J7	frosted medium tone	+\$0
J8	frosted black	+\$0

Top Finish: Wood-Grain Laminate
For laminate top with vinyl edge (TL)

LA	light ash	+\$0
LM	mahogany	+\$0

Top/Edge Finish: Recut Veneer
For recut veneer top (TR)

RA	light ash A	+\$0
RK	mahogany dark A	+\$0
RM	mahogany A	+\$0

Top/Edge Finish: Wood Veneer
For wood veneer top (TF)

V3	cherry A	+\$0
Z3	warm red cherry A	+\$0
Z5	maple A	+\$0
ED	aged cherry A	+\$20
EG	medium brown walnut A	+\$20
EK	medium red walnut A	+\$20
EY	light anigre A	+\$20
UL	natural maple A	+\$20
UQ	light cherry A	+\$20
UV	red cherry A	+\$20
UX	walnut on cherry A	+\$20

Step 10. Edge Finish
For laminate top with vinyl edge (TL)

8Q	folkstone grey	+\$0
91	white	+\$0
BU	black umber	+\$0
CL	cool grey neutral	+\$0
CM	cinnamon	+\$0
CO	chamomile	+\$0
G2	graphite satin	+\$0
HF	inner tone light	+\$0
HT	inner tone	+\$0
LA	light ash	+\$0
LM	mahogany	+\$0
LU	soft white	+\$0
MT	medium tone	+\$0
SG	slate grey	+\$0
WL	sandstone	+\$0
WN	warm grey neutral	+\$0

Step 11. Grommets

For 24" wide (24), 30" wide (30), 36" wide (36), 42" wide (42), or 48" wide (48)

NTG	no grommet	+\$0
C	grommet center	+\$27

Return Shell *continued*

For 60" wide (60), 66" wide (66), or 72" wide (72)

NTG	no grommet	+\$0
L	grommet left	+\$27
C	grommet center	+\$27
R	grommet right	+\$27
2LC	grommets left and center	+\$53
2CR	grommets center and right	+\$53
2LR	grommets left and right	+\$53
3LCR	grommets left, center, and right	+\$79

Step 12. Grommet Finish

For grommet left (L), grommet center (C), grommet right (R), grommets left and center (2LC), grommets center and right (2CR), grommets left and right (2LR), or grommets left, center, and right (3LCR)

8Q	folkstone grey	+\$0
91	white	+\$0
BU	black umber	+\$0
CL	cool grey neutral	+\$0
HF	inner tone light	+\$0
LU	soft white	+\$0
MT	medium tone	+\$0
SG	slate grey	+\$0
WL	sandstone	+\$0
WN	warm grey neutral	+\$0

Return with Single Pedestal

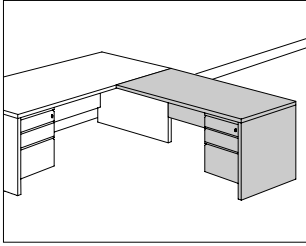

Product Information

Description

This return connects to a 5000 Series desk component for additional workspace. It has 1 lockable pedestal, a choice of pull and front styles (see chart below), 1 full end panel, and 1" adjustable glides. Box drawers have 1 drawer divider. B- and F-pull file drawers hold letter-size front-to-back hanging files; they also include 2 file converters for legal-size filing. Standard-, contour-, and bevel-pull file drawers include 1 file compressor for letter-size front-to-back or side-to-side hanging files or legal-size side-to-side hanging files. File drawers have full-extension steel ball-bearing slides. Attachment hardware is included.

The return has a laminate top and vinyl edge or a veneer top and edge and is available with or without grommets. A grommet is not available on the pedestal side of the return. The return has a full, raised, or open back panel. The full back panel extends to the floor; the raised back panel is 8¹/₈" from the floor and provides access to electrical components in panel system raceways; the open back panel is used against architectural walls or panel systems and provides maximum access to electrical/data outlets, including those complying with ADA standards. The open back panel includes a horizontal support rail; the bottom of the support rail is 8¹/₈" from the floor.

Pull Style—Pull Material—Front Style

Standard—Metal pull—Wood Veneer front

Standard—Metal pull—Recut Veneer front

Standard—Metal pull—Metal front

Bevel—Metal pull—Metal front

Contour—Aluminum or Wood pull—Metal front

F-pull—Plastic pull—Metal front

B-pull—Plastic pull—Plastic front

Notes

B- and F-pull pedestals have a smooth-steel case.

Box/box/file and file/file pedestal combinations with standard, contour, or bevel pulls hang 3³/₄" below raised back panel; box/box/file and file/file pedestal combinations with B and F pulls hang 6" below raised back panel.

Pedestals with standard, bevel, and contour pulls are 3³/₈" wider than pedestals with B and F pulls. Drawer accessories for pedestals with standard, bevel, and contour pulls are not interchangeable with accessories for pedestals with B and F pulls.

Order optional desk components separately:

- Corner desk
- Curved corner desk
- Desk shell
- Desk with single pedestal

To manage cables under return, order cable management trough separately.

Order optional display or storage components separately:

- Desk-mounted tackboard
- Desk-mounted tool rail with tackboard
- End-mounted tackboard
- Flipper door unit

For accessory product applications, the following Compatibility Charts are available electronically for viewing and printing in Kiosk and HermanMiller.com: Keyboard Compatibility Charts, Pencil Drawer Compatibility Charts, and Work Organizer Compatibility Chart.

Pedestal ships with lock plugs keyed differently (KD). For keyed-alike locks on multiple pedestals, specify keyed alike (KA); separate lock plugs are shipped and field installed on each pedestal. See Keyed-Alike Information in Appendices.

Return with Single Pedestal

continued

Dimensions

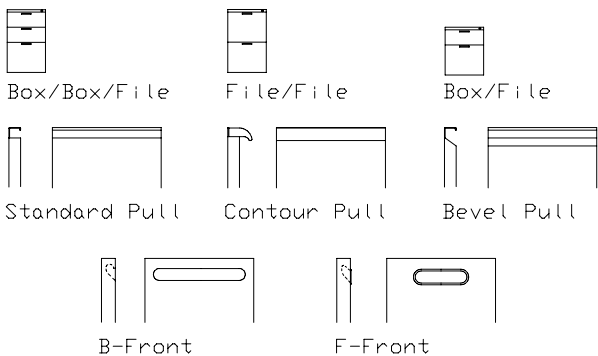
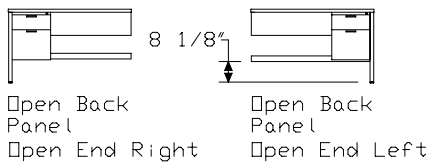
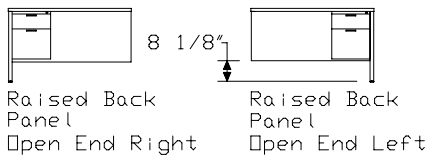
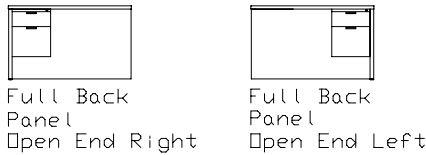

Specification Information

Step 1.		
5		
Step 2. Back Panel		
F	full back panel	\$0
R	raised back panel	\$0
P	open back panel	\$0
Step 3. Pedestal Pull/Front Style		
6-	standard pull with painted front	+\$171
R-	standard pull with recut veneer front A	+\$456
F-	standard pull with wood veneer front A	+\$482
5-	contour pull	+\$300
4-	bevel pull	+\$171
X-	B-pull	+\$146
Y-	F-pull	+\$118
Step 4. Width		
24	24" wide	+\$0
30	30" wide	+\$0
36	36" wide	+\$0
42	42" wide	+\$0
48	48" wide	+\$0
60	60" wide	+\$0
66	66" wide	+\$0
72	72" wide	+\$0
Step 5. Depth		
<i>For standard pull with painted front (6-), standard pull with recut veneer front (R-), standard pull with wood veneer front (F-), contour pull (5-), or bevel pull (4-) with 24" wide (24)</i>		
20-	20" deep	+\$475
24-	24" deep	+\$490
30-	30" deep	+\$541
<i>For standard pull with painted front (6-), standard pull with recut veneer front (R-), standard pull with wood veneer front (F-), contour pull (5-), or bevel pull (4-) with 30" wide (30)</i>		
20-	20" deep	+\$504
24-	24" deep	+\$517
30-	30" deep	+\$567

Return with Single Pedestal

continued

For standard pull with painted front (6-), standard pull with recut veneer front (R-), standard pull with wood veneer front (F-), contour pull (5-), or bevel pull (4-) with 36" wide (36)

20-	20" deep	+\$535
24-	24" deep	+\$546
30-	30" deep	+\$602

For standard pull with painted front (6-), standard pull with recut veneer front (R-), standard pull with wood veneer front (F-), contour pull (5-), or bevel pull (4-) with 42" wide (42)

20-	20" deep	+\$554
24-	24" deep	+\$580
30-	30" deep	+\$635

For standard pull with painted front (6-), standard pull with recut veneer front (R-), standard pull with wood veneer front (F-), contour pull (5-), or bevel pull (4-) with 48" wide (48)

20-	20" deep	+\$585
24-	24" deep	+\$610
30-	30" deep	+\$656

For standard pull with painted front (6-), standard pull with recut veneer front (R-), standard pull with wood veneer front (F-), contour pull (5-), or bevel pull (4-) with 60" wide (60)

20-	20" deep	+\$625
24-	24" deep	+\$679
30-	30" deep	+\$749

For standard pull with painted front (6-), standard pull with recut veneer front (R-), standard pull with wood veneer front (F-), contour pull (5-), or bevel pull (4-) with 66" wide (66)

20-	20" deep	+\$717
24-	24" deep	+\$776
30-	30" deep	+\$838

For standard pull with painted front (6-), standard pull with recut veneer front (R-), standard pull with wood veneer front (F-), contour pull (5-), or bevel pull (4-) with 72" wide (72)

20-	20" deep	+\$828
24-	24" deep	+\$886
30-	30" deep	+\$950

For B-pull (X-) or F-pull (Y-) with 24" wide (24)

24-	24" deep	+\$490
30-	30" deep	+\$541

For B-pull (X-) or F-pull (Y-) with 30" wide (30)

24-	24" deep	+\$517
30-	30" deep	+\$567

For B-pull (X-) or F-pull (Y-) with 36" wide (36)

24-	24" deep	+\$546
30-	30" deep	+\$602

For B-pull (X-) or F-pull (Y-) with 42" wide (42)

24-	24" deep	+\$580
30-	30" deep	+\$635

For B-pull (X-) or F-pull (Y-) with 48" wide (48)

24-	24" deep	+\$610
30-	30" deep	+\$656

For B-pull (X-) or F-pull (Y-) with 60" wide (60)

24-	24" deep	+\$679
30-	30" deep	+\$749

For B-pull (X-) or F-pull (Y-) with 66" wide (66)

24-	24" deep	+\$776
30-	30" deep	+\$838

For B-pull (X-) or F-pull (Y-) with 72" wide (72)

24-	24" deep	+\$886
30-	30" deep	+\$950

Step 6. Configuration (from User Side)

OHD	open end left, box/box/file right	+\$288
OGD	open end left, file/file right	+\$249
OAD	open end left, box/file right	+\$132
HOD	box/box/file left, open end right	+\$288
GOD	file/file left, open end right	+\$249
AOD	box/file left, open end right	+\$132

Step 7. Steel Type

For standard pull with painted front (6-), standard pull with recut veneer front (R-), standard pull with wood veneer front (F-), contour pull (5-), or bevel pull (4-)

SS	smooth paint on smooth steel	+\$0
TS	smooth paint on textured steel	+\$0

For B-pull (X-) or F-pull (Y-)

SS	smooth paint on smooth steel	+\$0
-----------	------------------------------	------

Return with Single Pedestal

continued

Step 8. Understructure Finish
See *Finish Colors* list for paint codes.

For standard pull with painted front (6-), standard pull with recut veneer front (R-), standard pull with wood veneer front (F-), contour pull (5-), or bevel pull (4-)

Nonmetallic Paint	+\$0
Metallic Paint	+\$80

For B-pull (X-)

8Q folkstone grey	+\$0
BU black umber	+\$0
HF inner tone light	+\$0
LT light tone	+\$0
LU soft white	+\$0
MT medium tone	+\$0
SG slate grey	+\$0
WL sandstone	+\$0

For F-pull (Y-)

8Q folkstone grey	+\$0
BU black umber	+\$0
HF inner tone light	+\$0
LT light tone	+\$0
LU soft white	+\$0
MT medium tone	+\$0
SG slate grey	+\$0
WL sandstone	+\$0
CN metallic champagne	+\$80
EH metallic bronze	+\$80
MS metallic silver	+\$80

Step 9. Pull Type

For contour pull (5-)

1P painted	+\$0
1S stained A	+\$0

Step 10. Pull Finish

See *Finish Colors* list for paint codes.

For painted (1P)

Nonmetallic Paint	+\$0
Metallic Paint	+\$0

Solid Woods

For stained (1S)

V3 cherry A	+\$0
Z3 warm red cherry A	+\$0
Z5 maple A	+\$0
ED aged cherry A	+\$10
EG medium brown walnut A	+\$10
EK medium red walnut A	+\$10
EY light anigre A	+\$10
UL natural maple A	+\$10
UQ light cherry A	+\$10
UV red cherry A	+\$10
UX walnut on cherry A	+\$10

Step 11. Top

For standard pull with painted front (6-), contour pull (5-), bevel pull (4-), B-pull (X-), or F-pull (Y-)

		24	30	36	42	48
NT disposable top		-\$37	-37	-37	-37	-37
TL laminate top with vinyl edge		+\$0	0	0	0	0
TR recut veneer top A		+\$297	297	313	340	367
TF wood veneer top A		+\$349	349	368	402	433
				60	66	72
NT disposable top			-\$37	-37	-37	
TL laminate top with vinyl edge			+\$0	0	0	
TR recut veneer top A			+\$399	412	426	
TF wood veneer top A			+\$471	486	500	

For standard pull with recut veneer front (R-)

		24	30	36	42	48
TR recut veneer top A		+\$297	297	313	340	367
				60	66	72
TR recut veneer top A			+\$399	412	426	

For standard pull with wood veneer front (F-)

		24	30	36	42	48
TF wood veneer top A		+\$349	349	368	402	433
				60	66	72
TF wood veneer top A			+\$471	486	500	

Return with Single Pedestal

continued

Step 12.

Top Finish: Solid-Color Laminate

For laminate top with vinyl edge (TL)

8Q	folkstone grey	+\$0
91	white	+\$0
CL	cool grey neutral	+\$0
HF	inner tone light	+\$0
HT	inner tone	+\$0
LT	light tone	+\$0
LU	soft white	+\$0
WL	sandstone	+\$0
WN	warm grey neutral	+\$0

Top Finish: Fiber Laminate

For laminate top with vinyl edge (TL)

1X	vanilla	+\$0
2X	wheat	+\$0
3X	celery	+\$0
4X	coriander	+\$0
5X	chamomile	+\$0
6X	cinnamon	+\$0
7X	cardamom	+\$0
8X	kale	+\$0

Top Finish: Frosted Laminate

For laminate top with vinyl edge (TL)

J4	frosted light grey	+\$0
J5	frosted inner tone light	+\$0
J6	frosted slate grey	+\$0
J7	frosted medium tone	+\$0
J8	frosted black	+\$0

Top Finish: Wood-Grain Laminate

For laminate top with vinyl edge (TL)

LA	light ash	+\$0
LM	mahogany	+\$0

Top/Edge Finish: Recut Veneer

For standard pull with painted front (6-), contour pull (5-), bevel pull (4-), B-pull (X-), or F-pull (Y-) with recut veneer top (TR)

RA	light ash <input type="checkbox"/>	+\$0
RK	mahogany dark <input type="checkbox"/>	+\$0
RM	mahogany <input type="checkbox"/>	+\$0

Top/Edge Finish: Wood Veneer

For standard pull with painted front (6-), bevel pull (4-), B-pull (X-), or F-pull (Y-) with wood veneer top (TF)

V3	cherry <input type="checkbox"/>	+\$0
Z3	warm red cherry <input type="checkbox"/>	+\$0
Z5	maple <input type="checkbox"/>	+\$0
ED	aged cherry <input type="checkbox"/>	+\$20
EG	medium brown walnut <input type="checkbox"/>	+\$20
EK	medium red walnut <input type="checkbox"/>	+\$20
EY	light anigre <input type="checkbox"/>	+\$20
UL	natural maple <input type="checkbox"/>	+\$20
UQ	light cherry <input type="checkbox"/>	+\$20
UV	red cherry <input type="checkbox"/>	+\$20
UX	walnut on cherry <input type="checkbox"/>	+\$20

Front/Top/Edge Finish: Recut Veneer

For standard pull with recut veneer front (R-) with recut veneer top (TR)

RA	light ash <input type="checkbox"/>	+\$0
RK	mahogany dark <input type="checkbox"/>	+\$0
RM	mahogany <input type="checkbox"/>	+\$0

Front/Top/Edge Finish: Wood Veneer

For standard pull with wood veneer front (F-) with wood veneer top (TF)

V3	cherry <input type="checkbox"/>	+\$0
Z3	warm red cherry <input type="checkbox"/>	+\$0
Z5	maple <input type="checkbox"/>	+\$0
ED	aged cherry <input type="checkbox"/>	+\$50
EG	medium brown walnut <input type="checkbox"/>	+\$50
EK	medium red walnut <input type="checkbox"/>	+\$50
EY	light anigre <input type="checkbox"/>	+\$50
UL	natural maple <input type="checkbox"/>	+\$50
UQ	light cherry <input type="checkbox"/>	+\$50
UV	red cherry <input type="checkbox"/>	+\$50
UX	walnut on cherry <input type="checkbox"/>	+\$50

Top/Edge Finish: Wood Veneer

For contour pull (5-) with wood veneer top (TF)

V3	cherry <input type="checkbox"/>	+\$0
Z3	warm red cherry <input type="checkbox"/>	+\$0
Z5	maple <input type="checkbox"/>	+\$0

Return with Single Pedestal

continued

5000 Series Work Surfaces

Step 13. Edge Finish

For laminate top with vinyl edge (TL)

8Q	folkstone grey	+\$0
91	white	+\$0
BU	black umber	+\$0
CL	cool grey neutral	+\$0
CM	cinnamon	+\$0
CO	chamomile	+\$0
G2	graphite satin	+\$0
HF	inner tone light	+\$0
HT	inner tone	+\$0
LA	light ash	+\$0
LM	mahogany	+\$0
LU	soft white	+\$0
MT	medium tone	+\$0
SG	slate grey	+\$0
WL	sandstone	+\$0
WN	warm grey neutral	+\$0

Step 14. Grommets

For 24" wide (24) or 30" wide (30)

NTG	no grommet	+\$0
------------	------------	------

For 36" wide (36), 42" wide (42), or 48" wide (48)

NTG	no grommet	+\$0
C	grommet center	+\$27

For 60" wide (60) with open end left, box/box/file right (OHD), open end left, file/file right (OGD) or open end left, box/file right (OAD); 66" wide (66) with open end left, box/box/file right (OHD), open end left, file/file right (OGD) or open end left, box/file right (OAD); 72" wide (72) with open end left, box/box/file right (OHD), open end left, file/file right (OGD) or open end left, box/file right (OAD)

NTG	no grommet	+\$0
L	grommet left	+\$27
C	grommet center	+\$27
2LC	grommets left and center	+\$53

For 60" wide (60) with box/box/file left, open end right (HOD), file/file left, open end right (GOD) or box/file left, open end right (AOD); 66" wide (66) with box/box/file left, open end right (HOD), file/file left, open end right (GOD) or box/file left, open end right (AOD); 72" wide (72) with box/box/file left, open end right (HOD), file/file left, open end right (GOD) or box/file left, open end right (AOD)

NTG	no grommet	+\$0
R	grommet right	+\$27
C	grommet center	+\$27
2CR	grommets center and right	+\$53

Step 15. Grommet Finish

For grommet left (L), grommet right (R), grommet center (C), grommets center and right (2CR), or grommets left and center (2LC)

8Q	folkstone grey	+\$0
91	white	+\$0
BU	black umber	+\$0
CL	cool grey neutral	+\$0
HF	inner tone light	+\$0
LU	soft white	+\$0
MT	medium tone	+\$0
SG	slate grey	+\$0
WL	sandstone	+\$0
WN	warm grey neutral	+\$0

Step 16. Lock

For standard pull with painted front (6-), standard pull with recut veneer front (R-), standard pull with wood veneer front (F-), contour pull (5-), or bevel pull (4-)

KD	keyed differently with black lock	+\$0
KC	keyed differently with chrome lock	+\$0
KA	keyed alike	+\$0

For B-pull (X-) or F-pull (Y-)

KD	keyed differently with black lock	+\$0
KA	keyed alike	+\$0

Corner Return Shell

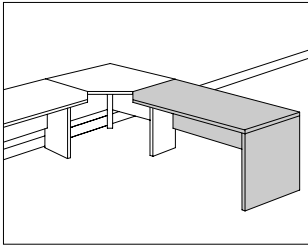

Product Information

Description

This return connects to a 5000 Series corner desk for additional workspace. It has a laminate top and vinyl edge or a veneer top and edge and is available with or without grommets. The return has 1 full end panel or 1 10"-deep recessed end panel and 1" adjustable glides. The return with a recessed end panel has a cable management cutout at the back of the panel. The 24"-deep return has a 4" front corner cut; the 30"-deep return has a 6" front corner cut. Each return is available with a full, raised, or open back panel. The full back panel extends to the floor; the raised back panel is 8 1/8" from the floor and provides access to electrical components in panel system raceways; the open back panel is used against architectural walls or panel systems and provides maximum access to electrical/data outlets, including those complying with ADA standards. The open back panel includes a horizontal support rail; the bottom of the support rail is 8 1/8" from the floor. Attachment hardware is included.

Notes

For aesthetic reasons, corner return should not attach to curved corner desk.

To connect corner return to straight-edged corner desk and maximize work surface space, use following guidelines:

- 24"-deep return with 4" front corner cut connects to 20"-deep corner desk
- 30"-deep return with 6" front corner cut connects to 24"-deep corner desk

To manage cables under corner return, order cable management trough separately.

Order optional display or storage components separately:

- Desk-mounted tackboard
- Desk-mounted tool rail with tackboard
- End-mounted tackboard
- Flipper door unit

For accessory product applications, the following Compatibility Charts are available electronically for viewing and printing in Kiosk and HermanMiller.com: Keyboard Compatibility Charts, Pencil Drawer Compatibility Charts, and Work Organizer Compatibility Chart.

Dimensions

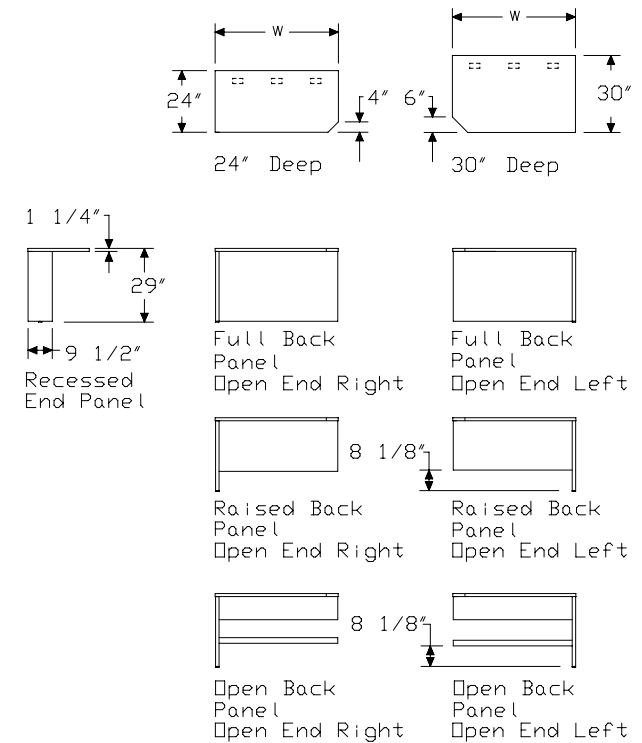

Specification Information

Step 1.

5

Step 2. Back Panel

F0-	full back panel	\$0
R0-	raised back panel	\$0
P0-	open back panel	\$0

Step 3. Width

30	30" wide	+\$0
36	36" wide	+\$0
42	42" wide	+\$0
48	48" wide	+\$0
60	60" wide	+\$0
66	66" wide	+\$0
72	72" wide	+\$0

Step 4. Depth

For 30" wide (30)

24C-	24" deep	+\$674
30C-	30" deep	+\$703

For 36" wide (36)

24C-	24" deep	+\$692
30C-	30" deep	+\$726

For 42" wide (42)

24C-	24" deep	+\$716
30C-	30" deep	+\$749

For 48" wide (48)

24C-	24" deep	+\$737
30C-	30" deep	+\$771

For 60" wide (60)

24C-	24" deep	+\$781
30C-	30" deep	+\$818

For 66" wide (66)

24C-	24" deep	+\$869
30C-	30" deep	+\$910

For 72" wide (72)

24C-	24" deep	+\$910
30C-	30" deep	+\$953

Step 5. End Panel (from User Side)

OSD	open end left, recessed end panel right	+\$0
OLD	open end left, full end panel right	+\$0
SOD	recessed end panel left, open end right	+\$0
LOD	full end panel left, open end right	+\$0

Step 6. Steel Type

SS	smooth paint on smooth steel	+\$0
TS	smooth paint on textured steel	+\$0

Step 7. Understructure Finish

See Finish Colors list for paint codes.

Nonmetallic Paint	+\$0
Metallic Paint	+\$40

Step 8. Top

		30	36	42	48	60
NT	disposable top	-\$37	-37	-37	-37	-37
TL	laminate top with vinyl edge	+\$0	0	0	0	0
TR	recut veneer top A	+\$297	313	340	367	399
TF	wood veneer top A	+\$349	368	402	433	471
					66	72
NT	disposable top				-\$37	-37
TL	laminate top with vinyl edge				+\$0	0
TR	recut veneer top A				+\$412	426
TF	wood veneer top A				+\$486	500

Step 9.

Top Finish: Solid-Color Laminate

For laminate top with vinyl edge (TL)

8Q	folkstone grey	+\$0
91	white	+\$0
CL	cool grey neutral	+\$0
HF	inner tone light	+\$0
HT	inner tone	+\$0
LT	light tone	+\$0
LU	soft white	+\$0
WL	sandstone	+\$0
WN	warm grey neutral	+\$0

Top Finish: Fiber Laminate		
<i>For laminate top with vinyl edge (TL)</i>		
1X	vanilla	+\$0
2X	wheat	+\$0
3X	celery	+\$0
4X	coriander	+\$0
5X	chamomile	+\$0
6X	cinnamon	+\$0
7X	cardamom	+\$0
8X	kale	+\$0

Top Finish: Frosted Laminate		
<i>For laminate top with vinyl edge (TL)</i>		
J4	frosted light grey	+\$0
J5	frosted inner tone light	+\$0
J6	frosted slate grey	+\$0
J7	frosted medium tone	+\$0
J8	frosted black	+\$0

Top Finish: Wood-Grain Laminate		
<i>For laminate top with vinyl edge (TL)</i>		
LA	light ash	+\$0
LM	mahogany	+\$0

Top/Edge Finish: Recut Veneer		
<i>For recut veneer top (TR)</i>		
RA	light ash A	+\$0
RK	mahogany dark A	+\$0
RM	mahogany A	+\$0

Top/Edge Finish: Wood Veneer		
<i>For wood veneer top (TF)</i>		
V3	cherry A	+\$0
Z3	warm red cherry A	+\$0
Z5	maple A	+\$0
ED	aged cherry A	+\$20
EG	medium brown walnut A	+\$20
EK	medium red walnut A	+\$20
EY	light anigre A	+\$20
UL	natural maple A	+\$20
UQ	light cherry A	+\$20
UV	red cherry A	+\$20
UX	walnut on cherry A	+\$20

Step 10. Edge Finish		
<i>For laminate top with vinyl edge (TL)</i>		
8Q	folkstone grey	+\$0
91	white	+\$0
BU	black umber	+\$0
CL	cool grey neutral	+\$0
CM	cinnamon	+\$0
CO	chamomile	+\$0
G2	graphite satin	+\$0
HF	inner tone light	+\$0
HT	inner tone	+\$0
LA	light ash	+\$0
LM	mahogany	+\$0
LU	soft white	+\$0
MT	medium tone	+\$0
SG	slate grey	+\$0
WL	sandstone	+\$0
WN	warm grey neutral	+\$0

Step 11. Grommets		
<i>For 30" wide (30), 36" wide (36), 42" wide (42), or 48" wide (48)</i>		
NTG	no grommet	+\$0
C	grommet center	+\$27

<i>For 60" wide (60), 66" wide (66), or 72" wide (72)</i>		
NTG	no grommet	+\$0
L	grommet left	+\$27
C	grommet center	+\$27
R	grommet right	+\$27
2LC	grommets left and center	+\$53
2CR	grommets center and right	+\$53
2LR	grommets left and right	+\$53
3LCR	grommets left, center, and right	+\$79

Corner Return Shell *continued*

5000 Series Work Surfaces

Step 12. Grommet Finish		
<i>For grommet left (L), grommet center (C), grommet right (R), grommets left and center (2LC), grommets center and right (2CR), grommets left and right (2LR), or grommets left, center, and right (3LCR)</i>		
8Q	folkstone grey	+\$0
91	white	+\$0
BU	black umber	+\$0
CL	cool grey neutral	+\$0
HF	inner tone light	+\$0
LU	soft white	+\$0
MT	medium tone	+\$0
SG	slate grey	+\$0
WL	sandstone	+\$0
WN	warm grey neutral	+\$0

Corner Return with Single Pedestal

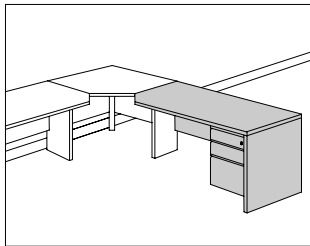

Product Information

Description

This return connects to a 5000 Series corner desk for additional workspace. It has 1 lockable pedestal and a choice of pull and front styles (see chart below). Box drawers have 1 drawer divider. B- and F-pull file drawers hold letter-size front-to-back hanging files; they also include 2 file converters for legal-size filing. Standard-, contour-, and bevel-pull file drawers include 1 file compressor for letter-size front-to-back or side-to-side hanging files or legal-size side-to-side hanging files. File drawers have full-extension steel ball-bearing slides.

The return has a laminate top and vinyl edge or a veneer top and edge and is available with or without grommets. A grommet is not available on the pedestal side of the return. The return has 1 full end panel and 1" adjustable glides. The 24"-deep return has a 4" cut at the front corner; the 30"-deep return has a 6" cut at the front corner. It is available with a full, raised, or open back panel. The full back panel extends to the floor; the raised back panel is 8¹/₈" from the floor and provides access to electrical components in panel system raceways; the open back panel is used against architectural walls or panel systems and provides maximum access to electrical/data outlets, including those complying with ADA standards. The open back panel includes a horizontal support rail; the bottom of the support rail is 8¹/₈" from the floor.

Pull Style—Pull Material—Front Style

Standard—Metal pull—Wood Veneer front

Standard—Metal pull—Recut Veneer front

Standard—Metal pull—Metal front

Bevel—Metal pull—Metal front

Contour—Aluminum or Wood pull—Metal front

F-pull—Plastic pull—Metal front

B-pull—Plastic pull—Plastic front

Notes

For aesthetic reasons, corner return with single pedestal should not attach to curved corner desk.

To connect corner return to straight-edged corner desk and maximize work surface space, use following guidelines:

- 24"-deep return with 4" front corner cut connects to 20"-deep corner desk
- 30"-deep return with 6" front corner cut connects to 24"-deep corner desk

B- and F-pull pedestals have a smooth-steel case.

Box/box/file and file/file pedestal combinations with standard, contour, or bevel pulls hang 3³/₄" below raised back panel; box/box/file and file/file pedestal combinations with B and F pulls hang 6" below raised back panel.

Pedestals with standard, bevel, and contour pulls are ³/₈" wider than pedestals with B and F pulls. Drawer accessories for pedestals with standard, bevel, and contour pulls are not interchangeable with accessories for pedestals with B and F pulls.

To manage cables under corner return, order cable management trough separately.

Order optional display or storage components separately:

- Corner desk-mounted tackboard
- Flipper door unit

For accessory product applications, the following Compatibility Charts are available electronically for viewing and printing in Kiosk and HermanMiller.com: Keyboard Compatibility Charts, Pencil Drawer Compatibility Charts, and Work Organizer Compatibility Chart.

Pedestal ships with lock plugs keyed differently (KD). For keyed-alike locks on multiple pedestals, specify keyed alike (KA); separate lock plugs are shipped and field installed on each pedestal. See Keyed-Alike Information in Appendices.

Corner Return with Single Pedestal *continued*

Dimensions

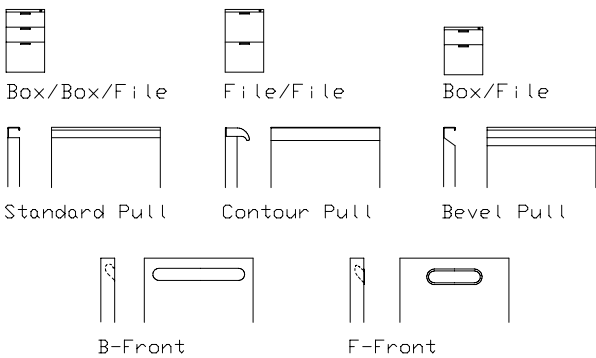
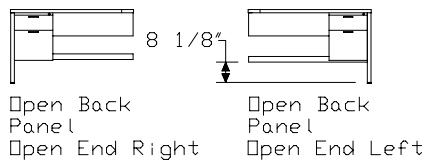
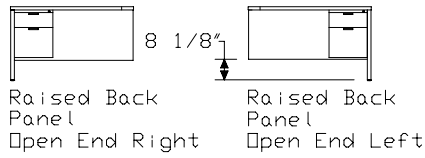
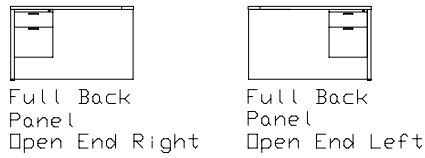
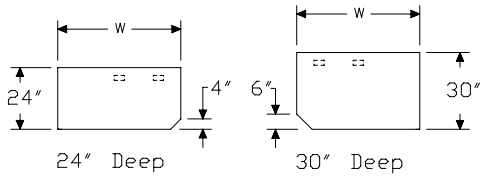

Specification Information

Step 1.		
5		
Step 2. Back Panel		
F	full back panel	\$0
R	raised back panel	\$0
P	open back panel	\$0
Step 3. Pedestal Pull/Front Style		
6-	standard pull with painted front	+\$162
R-	standard pull with recut veneer front A	+\$432
F-	standard pull with wood veneer front A	+\$456
5-	contour pull	+\$285
4-	bevel pull	+\$162
X-	B-pull	+\$137
Y-	F-pull	+\$112
Step 4. Width		
30	30" wide	+\$0
36	36" wide	+\$0
42	42" wide	+\$0
48	48" wide	+\$0
60	60" wide	+\$0
66	66" wide	+\$0
72	72" wide	+\$0
Step 5. Depth		
<i>For 30" wide (30)</i>		
24C-	24" deep	+\$575
30C-	30" deep	+\$621
<i>For 36" wide (36)</i>		
24C-	24" deep	+\$600
30C-	30" deep	+\$648
<i>For 42" wide (42)</i>		
24C-	24" deep	+\$627
30C-	30" deep	+\$681
<i>For 48" wide (48)</i>		
24C-	24" deep	+\$662
30C-	30" deep	+\$716

Corner Return with Single Pedestal *continued*

<i>For 60" wide (60)</i>		
24C-	24" deep	+\$716
30C-	30" deep	+\$770

<i>For 66" wide (66)</i>		
24C-	24" deep	+\$820
30C-	30" deep	+\$878

<i>For 72" wide (72)</i>		
24C-	24" deep	+\$934
30C-	30" deep	+\$1001

Step 6. Configuration (from User Side)		
OHD	open end left, box/box/file right	+\$288
OGD	open end left, file/file right	+\$249
OAD	open end left, box/file right	+\$238
HOD	box/box/file left, open end right	+\$288
GOD	file/file left, open end right	+\$249
AOD	box/file left, open end right	+\$238

Step 7. Steel Type		
<i>For standard pull with painted front (6-), standard pull with recut veneer front (R-), standard pull with wood veneer front (F-), contour pull (5-), or bevel pull (4-)</i>		
SS	smooth paint on smooth steel	+\$0
TS	smooth paint on textured steel	+\$0

<i>For B-pull (X-) or F-pull (Y-)</i>		
SS	smooth paint on smooth steel	+\$0

Step 8. Understructure Finish		
<i>See Finish Colors list for paint codes.</i>		
<i>For standard pull with painted front (6-), standard pull with recut veneer front (R-), standard pull with wood veneer front (F-), contour pull (5-), or bevel pull (4-)</i>		
	Nonmetallic Paint	+\$0
	Metallic Paint	+\$80

<i>For B-pull (X-)</i>		
8Q	folkstone grey	+\$0
BU	black umber	+\$0
HF	inner tone light	+\$0
LT	light tone	+\$0
LU	soft white	+\$0
MT	medium tone	+\$0
SG	slate grey	+\$0
WL	sandstone	+\$0

<i>For F-pull (Y-)</i>		
8Q	folkstone grey	+\$0
BU	black umber	+\$0
HF	inner tone light	+\$0
LT	light tone	+\$0
LU	soft white	+\$0
MT	medium tone	+\$0
SG	slate grey	+\$0
WL	sandstone	+\$0
CN	metallic champagne	+\$80
EH	metallic bronze	+\$80
MS	metallic silver	+\$80

Step 9. Pull Type		
<i>For contour pull (5-)</i>		
1P	painted	+\$0
1S	stained A	+\$0

Step 10. Pull Finish		
<i>See Finish Colors list for paint codes.</i>		
<i>For painted (1P)</i>		
	Nonmetallic Paint	+\$0
	Metallic Paint	+\$0

Corner Return with Single Pedestal *continued*

Solid Woods		
<i>For stained (1S)</i>		
V3	cherry A	+\$0
Z3	warm red cherry A	+\$0
Z5	maple A	+\$0
ED	aged cherry A	+\$10
EG	medium brown walnut A	+\$10
EK	medium red walnut A	+\$10
EY	light anigre A	+\$10
UL	natural maple A	+\$10
UQ	light cherry A	+\$10
UV	red cherry A	+\$10
UX	walnut on cherry A	+\$10

Step 11. Top

For standard pull with painted front (6-), contour pull (5-), bevel pull (4-), B-pull (X-), or F-pull (Y-)

		30	36	42	48	60
NT	disposable top	-\$37	-37	-37	-37	-37
TL	laminate top with vinyl edge	+\$0	0	0	0	0
TR	recut veneer top A	+\$297	313	340	367	399
TF	wood veneer top A	+\$349	368	402	433	471
				66	72	

NT	disposable top				-\$37	-37
TL	laminate top with vinyl edge				+\$0	0
TR	recut veneer top A				+\$412	426
TF	wood veneer top A				+\$486	500

For standard pull with recut veneer front (R-)

		30	36	42	48	60
TR	recut veneer top A	+\$297	313	340	367	399
				66	72	
TR	recut veneer top A				+\$412	426

For standard pull with wood veneer front (F-)

		30	36	42	48	60
TF	wood veneer top A	+\$349	368	402	433	471
				66	72	
TF	wood veneer top A				+\$486	500

Step 12.

Top Finish: Solid-Color Laminate

For laminate top with vinyl edge (TL)

8Q	folkstone grey	+\$0
91	white	+\$0
CL	cool grey neutral	+\$0
HF	inner tone light	+\$0
HT	inner tone	+\$0
LT	light tone	+\$0
LU	soft white	+\$0
WL	sandstone	+\$0
WN	warm grey neutral	+\$0

Top Finish: Fiber Laminate

For laminate top with vinyl edge (TL)

1X	vanilla	+\$0
2X	wheat	+\$0
3X	celery	+\$0
4X	coriander	+\$0
5X	chamomile	+\$0
6X	cinnamon	+\$0
7X	cardamom	+\$0
8X	kale	+\$0

Top Finish: Frosted Laminate

For laminate top with vinyl edge (TL)

J4	frosted light grey	+\$0
J5	frosted inner tone light	+\$0
J6	frosted slate grey	+\$0
J7	frosted medium tone	+\$0
J8	frosted black	+\$0

Top Finish: Wood-Grain Laminate

For laminate top with vinyl edge (TL)

LA	light ash	+\$0
LM	mahogany	+\$0

Top/Edge Finish: Recut Veneer

For standard pull with painted front (6-), contour pull (5-), bevel pull (4-), B-pull (X-), or F-pull (Y-) with recut veneer top (TR)

RA	light ash A	+\$0
RK	mahogany dark A	+\$0
RM	mahogany A	+\$0

Corner Return with Single Pedestal *continued*

Top/Edge Finish: Wood Veneer

For standard pull with painted front (6-), bevel pull (4-), B-pull (X-), or F-pull (Y-) with wood veneer top (TF)

V3	cherry <input type="checkbox"/>	+\$0
Z3	warm red cherry <input type="checkbox"/>	+\$0
Z5	maple <input type="checkbox"/>	+\$0
ED	aged cherry <input type="checkbox"/>	+\$20
EG	medium brown walnut <input type="checkbox"/>	+\$20
EK	medium red walnut <input type="checkbox"/>	+\$20
EY	light anigre <input type="checkbox"/>	+\$20
UL	natural maple <input type="checkbox"/>	+\$20
UQ	light cherry <input type="checkbox"/>	+\$20
UV	red cherry <input type="checkbox"/>	+\$20
UX	walnut on cherry <input type="checkbox"/>	+\$20

Front/Top/Edge Finish: Recut Veneer

For standard pull with recut veneer front (R-) with recut veneer top (TR)

RA	light ash <input type="checkbox"/>	+\$0
RK	mahogany dark <input type="checkbox"/>	+\$0
RM	mahogany <input type="checkbox"/>	+\$0

Front/Top/Edge Finish: Wood Veneer

For standard pull with wood veneer front (F-) with wood veneer top (TF)

V3	cherry <input type="checkbox"/>	+\$0
Z3	warm red cherry <input type="checkbox"/>	+\$0
Z5	maple <input type="checkbox"/>	+\$0
ED	aged cherry <input type="checkbox"/>	+\$50
EG	medium brown walnut <input type="checkbox"/>	+\$50
EK	medium red walnut <input type="checkbox"/>	+\$50
EY	light anigre <input type="checkbox"/>	+\$50
UL	natural maple <input type="checkbox"/>	+\$50
UQ	light cherry <input type="checkbox"/>	+\$50
UV	red cherry <input type="checkbox"/>	+\$50
UX	walnut on cherry <input type="checkbox"/>	+\$50

Top/Edge Finish: Wood Veneer

For contour pull (5-) with wood veneer top (TF)

V3	cherry <input type="checkbox"/>	+\$0
Z3	warm red cherry <input type="checkbox"/>	+\$0
Z5	maple <input type="checkbox"/>	+\$0

Step 13. Edge Finish

For laminate top with vinyl edge (TL)

8Q	folkstone grey	+\$0
91	white	+\$0
BU	black umber	+\$0
CL	cool grey neutral	+\$0
CM	cinnamon	+\$0
CO	chamomile	+\$0
G2	graphite satin	+\$0
HF	inner tone light	+\$0
HT	inner tone	+\$0
LA	light ash	+\$0
LM	mahogany	+\$0
LU	soft white	+\$0
MT	medium tone	+\$0
SG	slate grey	+\$0
WL	sandstone	+\$0
WN	warm grey neutral	+\$0

Step 14. Grommets

For 30" wide (30)

NTG	no grommet	+\$0
------------	------------	------

For 36" wide (36), 42" wide (42), or 48" wide (48)

NTG	no grommet	+\$0
C	grommet center	+\$27

For 60" wide (60) with open end left, box/box/file right (OHD), open end left, file/file right (OGD) or open end left, box/file right (OAD); 66" wide (66) with open end left, box/box/file right (OHD), open end left, file/file right (OGD) or open end left, box/file right (OAD); 72" wide (72) with open end left, box/box/file right (OHD), open end left, file/file right (OGD) or open end left, box/file right (OAD)

NTG	no grommet	+\$0
L	grommet left	+\$27
C	grommet center	+\$27
2LC	grommets left and center	+\$53

Corner Return with Single Pedestal *continued*

For 60" wide (60) with box/box/file left, open end right (HOD), file/file left, open end right (GOD) or box/file left, open end right (AOD); 66" wide (66) with box/box/file left, open end right (HOD), file/file left, open end right (GOD) or box/file left, open end right (AOD); 72" wide (72) with box/box/file left, open end right (HOD), file/file left, open end right (GOD) or box/file left, open end right (AOD)

NTG	no grommet	+\$0
R	grommet right	+\$27
C	grommet center	+\$27
2CR	grommets center and right	+\$53

Step 15. Grommet Finish

For grommet left (L), grommet right (R), grommet center (C), grommets center and right (2CR), or grommets left and center (2LC)

8Q	folkstone grey	+\$0
91	white	+\$0
BU	black umber	+\$0
CL	cool grey neutral	+\$0
HF	inner tone light	+\$0
LU	soft white	+\$0
MT	medium tone	+\$0
SG	slate grey	+\$0
WL	sandstone	+\$0
WN	warm grey neutral	+\$0

Step 16. Lock

For standard pull with painted front (6-), standard pull with recut veneer front (R-), standard pull with wood veneer front (F-), contour pull (5-), or bevel pull (4-)

KD	keyed differently with black lock	+\$0
KC	keyed differently with chrome lock	+\$0
KA	keyed alike	+\$0

For B-pull (X-) or F-pull (Y-)

KD	keyed differently with black lock	+\$0
KA	keyed alike	+\$0

Bridge

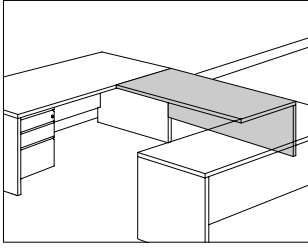

Product Information

Description

This bridge connects two 5000 Series components to provide a continuous work surface. It has a laminate top and vinyl edge or a veneer top and edge and is available with or without grommets. The bridge has a full, raised, or open back panel. The full back panel extends to the floor; the raised back panel is $8\frac{1}{8}$ " from the floor and provides access to electrical components in panel system raceways; the open back panel is used against architectural walls or panel systems and provides maximum access to electrical/data outlets, including those complying with ADA standards. The open back panel includes a horizontal support rail; the bottom of the support rail is $8\frac{1}{8}$ " from the floor. Attachment hardware is included.

Notes

Order optional desk components separately:

- Corner desk
- Curved corner desk
- Desk shell
- Desk with single pedestal

To manage cables under bridge, order cable management trough separately.

Order optional display or storage components separately:

- Desk-mounted tackboard
- Desk-mounted tool rail with tackboard
- End-mounted tackboard
- Flipper door unit

For accessory product applications, the following Compatibility Charts are available electronically for viewing and printing in Kiosk and HermanMiller.com: Keyboard Compatibility Charts, Pencil Drawer Compatibility Charts, and Work Organizer Compatibility Chart.

Dimensions

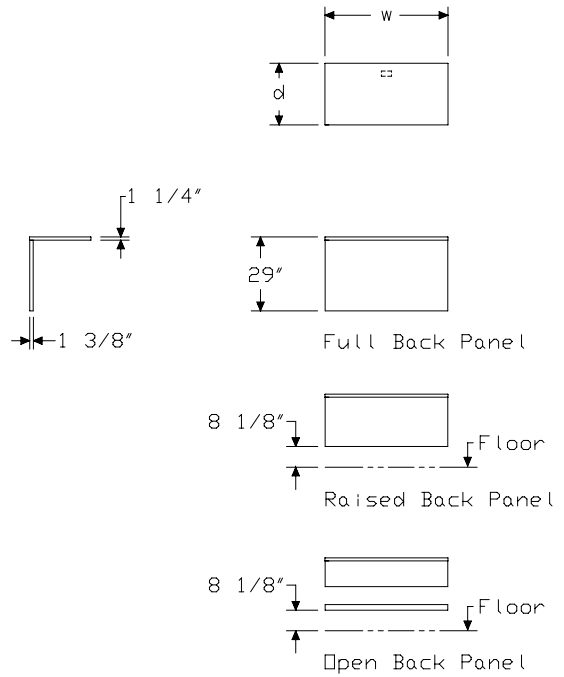

Specification Information		
Step 1.		
5		
Step 2. Back Panel		
F0-	full back panel	\$0
R0-	raised back panel	\$0
P0-	open back panel	\$0
Step 3. Width		
24	24" wide	+\$0
30	30" wide	+\$0
36	36" wide	+\$0
42	42" wide	+\$0
48	48" wide	+\$0
Step 4. Depth		
<i>For 24" wide (24)</i>		
20-D	20" deep	+\$327
24-D	24" deep	+\$339
<i>For 30" wide (30)</i>		
20-D	20" deep	+\$343
24-D	24" deep	+\$357
<i>For 36" wide (36)</i>		
20-D	20" deep	+\$360
24-D	24" deep	+\$374
30-D	30" deep	+\$393
<i>For 42" wide (42)</i>		
20-D	20" deep	+\$390
24-D	24" deep	+\$403
30-D	30" deep	+\$422
<i>For 48" wide (48)</i>		
20-D	20" deep	+\$431
24-D	24" deep	+\$445
30-D	30" deep	+\$467
Step 5. Steel Type		
SS	smooth paint on smooth steel	+\$0
TS	smooth paint on textured steel	+\$0

Step 6. Understructure Finish						
<i>See Finish Colors list for paint codes.</i>						
Nonmetallic Paint					+\$0	
Metallic Paint					+\$15	
Step 7. Top						
		24	30	36	42	48
NT	disposable top	-\$37	-37	-37	-37	-37
TL	laminate top with vinyl edge	+\$0	0	0	0	0
TR	recut veneer top A	+\$297	297	313	340	367
TF	wood veneer top A	+\$349	349	368	402	433
Step 8.						
Top Finish: Solid-Color Laminate						
<i>For laminate top with vinyl edge (TL)</i>						
8Q	folkstone grey					+\$0
91	white					+\$0
CL	cool grey neutral					+\$0
HF	inner tone light					+\$0
HT	inner tone					+\$0
LT	light tone					+\$0
LU	soft white					+\$0
WL	sandstone					+\$0
WN	warm grey neutral					+\$0
Top Finish: Fiber Laminate						
<i>For laminate top with vinyl edge (TL)</i>						
1X	vanilla					+\$0
2X	wheat					+\$0
3X	celery					+\$0
4X	coriander					+\$0
5X	chamomile					+\$0
6X	cinnamon					+\$0
7X	cardamom					+\$0
8X	kale					+\$0
Top Finish: Frosted Laminate						
<i>For laminate top with vinyl edge (TL)</i>						
J4	frosted light grey					+\$0
J5	frosted inner tone light					+\$0
J6	frosted slate grey					+\$0
J7	frosted medium tone					+\$0
J8	frosted black					+\$0

Top Finish: Wood-Grain Laminate
For laminate top with vinyl edge (TL)

LA	light ash	+\$0
LM	mahogany	+\$0

Top/Edge Finish: Recut Veneer
For recut veneer top (TR)

RA	light ash <input type="checkbox"/> A	+\$0
RK	mahogany dark <input type="checkbox"/> A	+\$0
RM	mahogany <input type="checkbox"/> A	+\$0

Top/Edge Finish: Wood Veneer
For wood veneer top (TF)

V3	cherry <input type="checkbox"/> A	+\$0
Z3	warm red cherry <input type="checkbox"/> A	+\$0
Z5	maple <input type="checkbox"/> A	+\$0
ED	aged cherry <input type="checkbox"/> A	+\$20
EG	medium brown walnut <input type="checkbox"/> A	+\$20
EK	medium red walnut <input type="checkbox"/> A	+\$20
EY	light anigre <input type="checkbox"/> A	+\$20
UL	natural maple <input type="checkbox"/> A	+\$20
UQ	light cherry <input type="checkbox"/> A	+\$20
UV	red cherry <input type="checkbox"/> A	+\$20
UX	walnut on cherry <input type="checkbox"/> A	+\$20

Step 9. Edge Finish
For laminate top with vinyl edge (TL)

8Q	folkstone grey	+\$0
91	white	+\$0
BU	black umber	+\$0
CL	cool grey neutral	+\$0
CM	cinnamon	+\$0
CO	chamomile	+\$0
G2	graphite satin	+\$0
HF	inner tone light	+\$0
HT	inner tone	+\$0
LA	light ash	+\$0
LM	mahogany	+\$0
LU	soft white	+\$0
MT	medium tone	+\$0
SG	slate grey	+\$0
WL	sandstone	+\$0
WN	warm grey neutral	+\$0

Step 10. Grommets

NTG	no grommet	+\$0
C	grommet center	+\$27

Step 11. Grommet Finish
For grommet center (C)

8Q	folkstone grey	+\$0
91	white	+\$0
BU	black umber	+\$0
CL	cool grey neutral	+\$0
HF	inner tone light	+\$0
LU	soft white	+\$0
MT	medium tone	+\$0
SG	slate grey	+\$0
WL	sandstone	+\$0
WN	warm grey neutral	+\$0

Corner Bridge

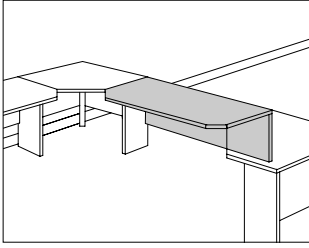

Product Information

Description

This corner bridge connects to a 5000 Series corner desk with a straight edge to provide a continuous work surface. It has a laminate top and vinyl edge or a veneer top and edge and is available with or without grommets. The bridge has one or two 4" or 6" diagonal cuts at the front corner to maximize workspace and minimize corner interference. It is available with a full, raised, or open back panel. The full back panel extends to the floor; the raised back panel is 8 1/8" from the floor and provides access to electrical components in panel system raceways; the open back panel is used against architectural walls or panel systems and provides maximum access to electrical/data outlets, including those complying with ADA standards. The open back panel includes a horizontal support rail; the bottom of the support rail is 8 1/8" from the floor. Attachment hardware is included.

Notes

For aesthetic reasons, corner bridge should not attach to curved corner desk.

To connect corner bridge to straight-edged corner desk and maximize work surface space, use following guidelines:

- 24"-deep bridge with 4" front corner cut connects to 20"-deep corner desk
- 30"-deep bridge with 6" front corner cut connects to 24"-deep corner desk

To manage cables under corner bridge, order cable management trough separately.

Order optional corner desk-mounted tackboard separately.

For accessory product applications, the following Compatibility Charts are available electronically for viewing and printing in Kiosk and HermanMiller.com: Keyboard Compatibility Charts, Pencil Drawer Compatibility Charts, and Work Organizer Compatibility Chart.

Dimensions

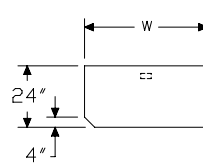

24" Deep
Corner Cut Left

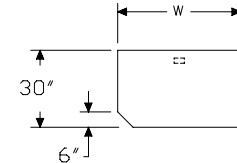

30" Deep
Corner Cut Left

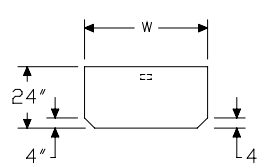

24" Deep
Double Corner Cut

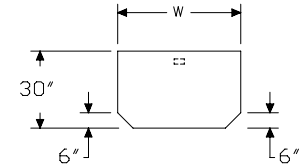

30" Deep
Double Corner Cut

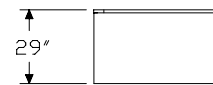
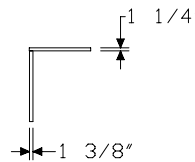

Full Back Panel

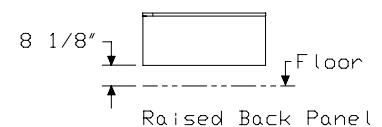

Raised Back Panel

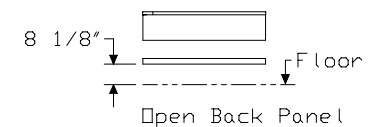

Open Back Panel

Specification Information

Step 1.	
5	

Step 2. Back Panel

F0-	full back panel	\$0
R0-	raised back panel	\$0
P0-	open back panel	\$0

Step 3. Width

24	24" wide	+\$0
30	30" wide	+\$0
36	36" wide	+\$0
42	42" wide	+\$0
48	48" wide	+\$0

Step 4. Depth

<i>For 24" wide (24)</i>		
24	24" deep	+\$339
30	30" deep	+\$359

<i>For 30" wide (30)</i>		
24	24" deep	+\$357
30	30" deep	+\$376

<i>For 36" wide (36)</i>		
24	24" deep	+\$374
30	30" deep	+\$393

<i>For 42" wide (42)</i>		
24	24" deep	+\$403
30	30" deep	+\$422

<i>For 48" wide (48)</i>		
24	24" deep	+\$445
30	30" deep	+\$467

Step 5. Corner Cut (from User Side)

<i>For 24" wide (24), 30" wide (30), or 36" wide (36)</i>		
L-D	corner cut left	+\$76
R-D	corner cut right	+\$76
D-D	double corner cut	+\$150

<i>For 42" wide (42) or 48" wide (48)</i>		
D-D	double corner cut	+\$150

Step 6. Steel Type		
SS	smooth paint on smooth steel	+\$0
TS	smooth paint on textured steel	+\$0

Step 7. Understructure Finish		
<i>See Finish Colors list for paint codes.</i>		
Nonmetallic Paint		+\$0
Metallic Paint		+\$15

Step 8. Top						
		24	30	36	42	48
NT	disposable top	-\$37	-37	-37	-37	-37
TL	laminate top with vinyl edge	+\$0	0	0	0	0
TR	recut veneer top <input type="checkbox"/> A	+\$297	297	313	340	367
TF	wood veneer top <input type="checkbox"/> A	+\$349	349	368	402	433

Step 9.

Top Finish: Solid-Color Laminate		
<i>For laminate top with vinyl edge (TL)</i>		
8Q	folkstone grey	+\$0
91	white	+\$0
CL	cool grey neutral	+\$0
HF	inner tone light	+\$0
HT	inner tone	+\$0
LT	light tone	+\$0
LU	soft white	+\$0
WL	sandstone	+\$0
WN	warm grey neutral	+\$0

Top Finish: Fiber Laminate		
<i>For laminate top with vinyl edge (TL)</i>		
1X	vanilla	+\$0
2X	wheat	+\$0
3X	celery	+\$0
4X	coriander	+\$0
5X	chamomile	+\$0
6X	cinnamon	+\$0
7X	cardamom	+\$0
8X	kale	+\$0

Top Finish: Frosted Laminate

For laminate top with vinyl edge (TL)

J4	frosted light grey	+\$0
J5	frosted inner tone light	+\$0
J6	frosted slate grey	+\$0
J7	frosted medium tone	+\$0
J8	frosted black	+\$0

Top Finish: Wood-Grain Laminate

For laminate top with vinyl edge (TL)

LA	light ash	+\$0
LM	mahogany	+\$0

Top/Edge Finish: Recut Veneer

For recut veneer top (TR)

RA	light ash A	+\$0
RK	mahogany dark A	+\$0
RM	mahogany A	+\$0

Top/Edge Finish: Wood Veneer

For wood veneer top (TF)

V3	cherry A	+\$0
Z3	warm red cherry A	+\$0
Z5	maple A	+\$0
ED	aged cherry A	+\$20
EG	medium brown walnut A	+\$20
EK	medium red walnut A	+\$20
EY	light anigre A	+\$20
UL	natural maple A	+\$20
UQ	light cherry A	+\$20
UV	red cherry A	+\$20
UX	walnut on cherry A	+\$20

Step 10. Edge Finish

For laminate top with vinyl edge (TL)

8Q	folkstone grey	+\$0
91	white	+\$0
BU	black umber	+\$0
CL	cool grey neutral	+\$0
CM	cinnamon	+\$0
CO	chamomile	+\$0
G2	graphite satin	+\$0
HF	inner tone light	+\$0
HT	inner tone	+\$0
LA	light ash	+\$0
LM	mahogany	+\$0
LU	soft white	+\$0
MT	medium tone	+\$0
SG	slate grey	+\$0
WL	sandstone	+\$0
WN	warm grey neutral	+\$0

Step 11. Grommets

NTG	no grommet	+\$0
C	grommet center	+\$27

Step 12. Grommet Finish

For grommet center (C)

8Q	folkstone grey	+\$0
91	white	+\$0
BU	black umber	+\$0
CL	cool grey neutral	+\$0
HF	inner tone light	+\$0
LU	soft white	+\$0
MT	medium tone	+\$0
SG	slate grey	+\$0
WL	sandstone	+\$0
WN	warm grey neutral	+\$0

Cable Management Trough

WM-67

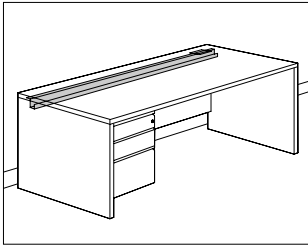

Product Information

Description

This 67"-long vinyl trough attaches under a 5000 Series work surface to manage cables. It holds 24 category 5 cables and has pre-punched mounting holes. The trough can be field cut to the appropriate length. Finish is black umber.

Dimensions

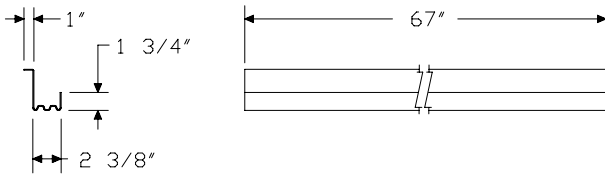

Specification Information

Step 1.

WM-67

\$45

5000 Series Work Surfaces

Electrical Distributor, Multi-Outlet

NP289

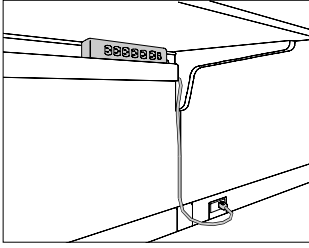

5000 Series Work Surfaces

Product Information

Description

This electrical distributor attaches to an Action Office® or Prospects® panel-suspended cable management trough or to a 5000 Series cable management trough. It also fits into an Abak® beam-attached cable channel. The electrical distributor provides additional receptacles at work surface height and has 6 standard, 3-prong receptacles with a 15-amp circuit breaker. It is UL listed and CSA certified. Finish is black umber.

Notes

For use with Action Office or Prospects products, order panel-suspended cable management trough (AO381.) separately.

For use with 5000 Series desk, order cable management trough (WM-67) separately.

For use with Abak products, order beam-attached cable channel (AK242.) separately.

Dimensions

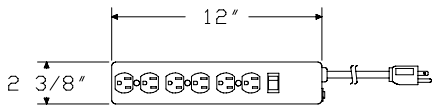

Specification Information

Step 1.

NP289

\$81

Credenza

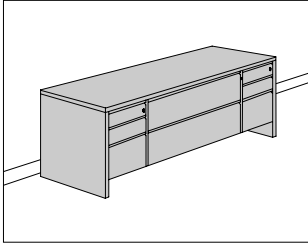

Product Information

Description

This freestanding 24"-deep credenza has painted front storage components with standard pulls, a laminate top and vinyl edge or a veneer top and edge, a full back panel, and 1" adjustable glides. It stores documents, binders, and books. The credenza has a lateral file/pedestal combination or a hinged-door storage cabinet/pedestal combination. The lateral file's interior (9P) holds front-to-back hanging files.

Notes

For keyed-alike credenzas, specify keyed alike (KA or KQ); separate lock plugs are shipped and field installed on each pedestal, lateral file, or door.

For keyed differently locks on each storage unit in the same credenza, contact Customer Care.

Dimensions

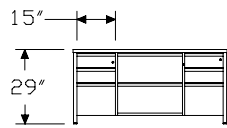
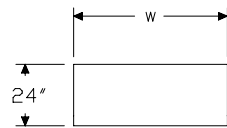

Lateral File
Full Back Panel

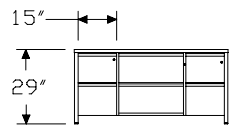

Lateral File
Full Back Panel

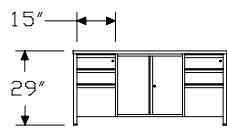

Storage Cabinet
Full Back Panel

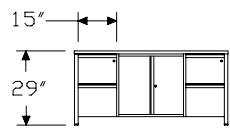

Storage Cabinet
Full Back Panel

Specification Information

Step 1.

5F6-

Step 2. Width

6324-	63" wide	\$1323
6924-	69" wide	\$1366
7524-	75" wide	\$1405

Step 3. Configuration

HNNH	box/box/file, lateral file, box/box/file	+\$1082
GNGG	file/file, lateral file, file/file	+\$1007
HSTH	box/box/file, storage cabinet, box/box/file	+\$1580
GSTG	file/file, storage cabinet, file/file	+\$1507

Step 4. Steel Type

SS	smooth paint on smooth steel	+\$0
TS	smooth paint on textured steel	+\$0

Step 5. Understructure Finish

See *Finish Colors list for paint codes.*

Nonmetallic Paint	+\$0
Metallic Paint	+\$140

Step 6. Top

		6324-	6924-	7524-
NT	disposable top	-\$37	-37	-37
TL	laminate top with vinyl edge	+\$0	0	0
TR	recut veneer top <input type="checkbox"/> A	+\$432	443	478
TF	wood veneer top <input type="checkbox"/> A	+\$513	525	536

Step 7.

Top Finish: Solid-Color Laminate

For *laminate top with vinyl edge (TL)*

8Q	folkstone grey	+\$0
91	white	+\$0
CL	cool grey neutral	+\$0
HF	inner tone light	+\$0
HT	inner tone	+\$0
LT	light tone	+\$0
LU	soft white	+\$0
WL	sandstone	+\$0
WN	warm grey neutral	+\$0

Top Finish: Fiber Laminate		
<i>For laminate top with vinyl edge (TL)</i>		
1X	vanilla	+\$0
2X	wheat	+\$0
3X	celery	+\$0
4X	coriander	+\$0
5X	chamomile	+\$0
6X	cinnamon	+\$0
7X	cardamom	+\$0
8X	kale	+\$0

Top Finish: Frosted Laminate		
<i>For laminate top with vinyl edge (TL)</i>		
J4	frosted light grey	+\$0
J5	frosted inner tone light	+\$0
J6	frosted slate grey	+\$0
J7	frosted medium tone	+\$0
J8	frosted black	+\$0

Top Finish: Wood-Grain Laminate		
<i>For laminate top with vinyl edge (TL)</i>		
LA	light ash	+\$0
LM	mahogany	+\$0

Top/Edge Finish: Recut Veneer		
<i>For recut veneer top (TR)</i>		
RA	light ash <input type="checkbox"/> A	+\$0
RK	mahogany dark <input type="checkbox"/> A	+\$0
RM	mahogany <input type="checkbox"/> A	+\$0

Top/Edge Finish: Wood Veneer		
<i>For wood veneer top (TF)</i>		
V3	cherry <input type="checkbox"/> A	+\$0
Z3	warm red cherry <input type="checkbox"/> A	+\$0
Z5	maple <input type="checkbox"/> A	+\$0
ED	aged cherry <input type="checkbox"/> A	+\$20
EG	medium brown walnut <input type="checkbox"/> A	+\$20
EK	medium red walnut <input type="checkbox"/> A	+\$20
EY	light anigre <input type="checkbox"/> A	+\$20
UL	natural maple <input type="checkbox"/> A	+\$20
UQ	light cherry <input type="checkbox"/> A	+\$20
UV	red cherry <input type="checkbox"/> A	+\$20
UX	walnut on cherry <input type="checkbox"/> A	+\$20

Step 8. Edge Finish		
<i>For laminate top with vinyl edge (TL)</i>		
8Q	folkstone grey	+\$0
91	white	+\$0
BU	black umber	+\$0
CL	cool grey neutral	+\$0
CM	cinnamon	+\$0
CO	chamomile	+\$0
G2	graphite satin	+\$0
HF	inner tone light	+\$0
HT	inner tone	+\$0
LA	light ash	+\$0
LM	mahogany	+\$0
LU	soft white	+\$0
MT	medium tone	+\$0
SG	slate grey	+\$0
WL	sandstone	+\$0
WN	warm grey neutral	+\$0

Step 9. Lock		
<i>For box/box/file, lateral file, box/box/file (HNNH) or file/file, lateral file, file/file (GNNG)</i>		
KD	keyed differently with black lock	+\$0
KC	keyed differently with chrome lock	+\$0
KA	keyed alike	+\$0

<i>For box/box/file, storage cabinet, box/box/file (HSTH) or file/file, storage cabinet, file/file (GSTG)</i>		
KD	keyed differently with black lock	+\$0
KC	keyed differently with chrome lock	+\$0
KA	keyed alike with black lock	+\$0
KQ	keyed alike with chrome lock	+\$0

Flipper Door Unit

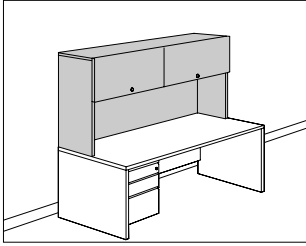

Product Information

Description

This lockable storage unit hangs from 2 straight-end panels at each end of a 5000 Series desk component. It includes a flipper door to enclose binders, files, and other items. The underside of the unit accepts a task light. The flipper door unit has a painted, fabric-covered, or veneer front. It is available with an open or closed back. The closed back unit has a tackboard or a tool rail with an 8¹/₂"-high tackboard on top. Attachment hardware is included.

Notes

When flipper door is open, it sits on top of storage unit.

Flipper door units wider than 48" have 2 doors.

Tool rail has same paint color as flipper door unit. For different color options, contact Customer Care.

Order optional task light separately:

- Performance task light (G6114.)
- Utility task light (G6136.)

For accessory product applications, the following Compatibility Charts are available electronically for viewing and printing in Kiosk and HermanMiller.com: Keyboard Compatibility Charts, Pencil Drawer Compatibility Charts, and Work Organizer Compatibility Chart.

Fabric-covered flipper door, tackboard, and tool rail/tackboard accept Customer's Own Material (COM). Yardage is estimated for directional, 54"-wide fabrics.

Flipper Door:

Width—Yardage

30" — 1¹/₈

36" — 1¹/₄

42" — 1³/₈

48" — 1³/₅

60" — 1¹/₂

66" — 1¹/₂

72" — 1¹/₂

Tackboard (T):

Width—Yardage

30" — 1¹/₈

36" — 1¹/₄

42" — 1¹/₂

48" — 1³/₅

60" — 2¹/₄

66" — 2¹/₂

72" — 2¹/₂

Tool Rail/Tackboard (R):

Width—Yardage

30" — 1¹/₈

36" — 1¹/₄

42" — 1¹/₂

48" — 1³/₅

60" — 2¹/₄

66" — 2¹/₂

72" — 2¹/₂

For information on multiple quantities or directional fabrics, contact COM Department. See Order Information in Appendices.

For keyed-alike flipper door units, specify keyed alike (KA or KQ); separate lock plugs are shipped and field installed on each flipper door unit.

Flipper Door Unit *continued*

Dimensions

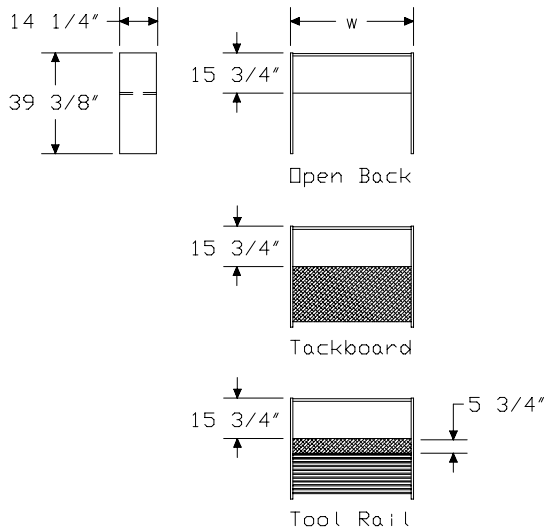

Specification Information

Step 1.

Step 2. Door Material	
-	painting door \$0
F-	fabric door \$173
WR-	recut veneer door <input type="checkbox"/> A \$268
WF-	wood veneer door <input type="checkbox"/> A \$293

Step 3. Width

For painting door (-) or fabric door (F-)	
3039-OD	30" wide +\$863
3639-OD	36" wide +\$922
4239-OD	42" wide +\$976
4839-OD	48" wide +\$1026
6039-OD	60" wide +\$1175
6639-OD	66" wide +\$1228
7239-OD	72" wide +\$1292

For recut veneer door (WR-) or wood veneer door (WF-)	
3039-OD	30" wide <input type="checkbox"/> A +\$863
3639-OD	36" wide <input type="checkbox"/> A +\$922
4239-OD	42" wide <input type="checkbox"/> A +\$976
4839-OD	48" wide <input type="checkbox"/> A +\$1026
6039-OD	60" wide <input type="checkbox"/> A +\$1391
6639-OD	66" wide <input type="checkbox"/> A +\$1441
7239-OD	72" wide <input type="checkbox"/> A +\$1507

Step 4. Back

O	open back +\$0
T	tackboard +\$223
R	tool rail +\$371

Flipper Door Unit *continued*

Step 5. Door Finish

See application chart and textiles list for fabric usage and numbers. First 2 digits of number indicate fabric line; remaining digit(s) indicate fabric color.

For fabric door (F-)

Price Category 1	+\$0
Price Category 2	+\$10
Price Category 3	+\$15
Price Category 4	+\$25
Price Category B	+\$39
Price Category C	+\$59
Price Category D	+\$78
Price Category E	+\$98
Price Category F	+\$135

Recut Veneer

For recut veneer door (WR-)

RA light ash <input type="checkbox"/>	+\$0
RK mahogany dark <input type="checkbox"/>	+\$0
RM mahogany <input type="checkbox"/>	+\$0

Wood Veneer

For wood veneer door (WF-)

V3 cherry <input type="checkbox"/>	+\$0
Z3 warm red cherry <input type="checkbox"/>	+\$0
Z5 maple <input type="checkbox"/>	+\$0
ED aged cherry <input type="checkbox"/>	+\$25
EG medium brown walnut <input type="checkbox"/>	+\$25
EK medium red walnut <input type="checkbox"/>	+\$25
EY light anigre <input type="checkbox"/>	+\$25
UL natural maple <input type="checkbox"/>	+\$25
UQ light cherry <input type="checkbox"/>	+\$25
UV red cherry <input type="checkbox"/>	+\$25
UX walnut on cherry <input type="checkbox"/>	+\$25

Step 6. Steel Type

SS smooth paint on smooth steel	+\$0
TS smooth paint on textured steel	+\$0

Step 7. Case/End Panel/Door/Tool Rail Finish

See Finish Colors list for paint codes.

Nonmetallic Paint	+\$0
Metallic Paint	+\$30

Step 8. Tackboard Fabric

See application chart and textiles list for fabric usage and numbers. First 2 digits of number indicate fabric line; remaining digit(s) indicate fabric color.

	T	R
Price Category 1	+\$0	0
Price Category 2	+\$10	5
Price Category 3	+\$50	25
Price Category 4	+\$79	40
Price Category B	+\$59	32
Price Category C	+\$88	47
Price Category D	+\$117	63
Price Category E	+\$147	78
Price Category F	+\$203	108

Step 9. Lock

KD keyed differently with black lock	+\$0
KC keyed differently with chrome lock	+\$0
KA keyed alike with black lock	+\$0
KQ keyed alike with chrome lock	+\$0

Shelf Divider

6-5-D

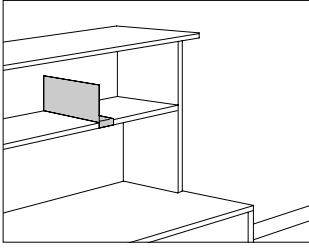

Product Information

Description

This divider attaches to a 5000 Series shelf to vertically divide books and binders. Finish is black umber.

Dimensions

Specification Information

Step 1.

6-5-D

\$27

5000 Series Storage

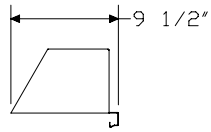
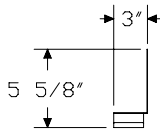

Pencil Drawer

72-20
72-21

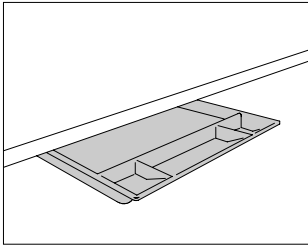

Product Information

Description

This plastic or metal pencil drawer mounts under a freestanding 5000 Series work surface to store pencils and other small items. Mounting hardware is included.

Notes

Plastic pencil drawer is available in black umber (BU) only.

Dimensions

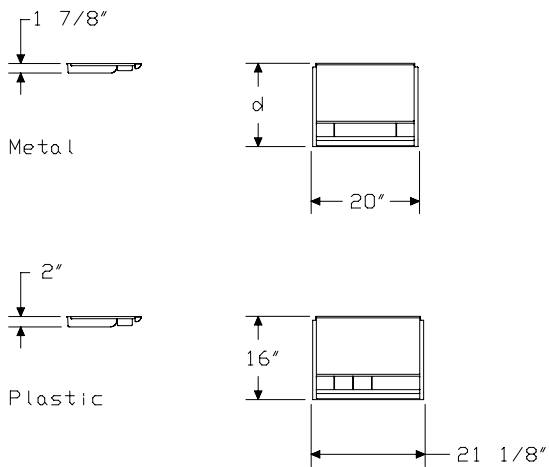

Specification Information

Step 1.

72-

Step 2. Material/Usage

2013-SP	metal for 20"-deep work surfaces	\$115
2016-SP	metal for 24", 30", or 36"-deep work surfaces	\$115
2116-2	plastic (available in black only)	\$91

Step 3. Finish

For metal for 20"-deep work surfaces (2013-SP) or metal for 24", 30", or 36"-deep work surfaces (2016-SP)

See Finish Colors list for paint codes.

Nonmetallic Paint	+\$0
Metallic Paint	+\$5

5000 Series Storage

Suspended Pedestal with Standard, Contour, or Bevel Pull

R-4-1
R-5-1
R-6-1
R-F-1
R-R-1

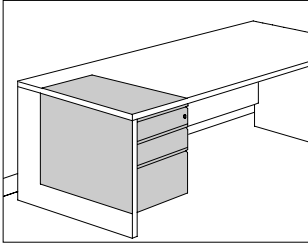

Product Information

Description

This lockable suspended pedestal mounts under a 5000 Series desk component and has a choice of pull and front styles (see chart below). Box drawers have 1 drawer divider; file drawers include 1 file compressor for letter-size front-to-back or side-to-side hanging files or legal-size side-to-side hanging files. All drawers have full-extension steel ball-bearing slides.

Pull Style—Pull Material—Front Style

Standard—Metal pull—Wood Veneer front

Standard—Metal pull—Recut Veneer front

Standard—Metal pull—Metal front

Bevel—Metal pull—Metal front

Contour—Aluminum or Wood pull—Metal front

Notes

Pedestals on each side of desk should be the same height.

Pedestals with standard, bevel, and contour pulls are $\frac{3}{8}$ " wider than pedestals with B and F pulls. Drawer accessories for pedestals with standard, bevel, and contour pulls are not interchangeable with accessories for pedestals with B and F pulls.

To determine pedestal size that fits under desk surface, refer to following chart:

Surface Depth—Pedestal Depth

20"—18"

24"—18" or 22"

30" return—18", 22", or 28"

30" desk—18" or 22"

36" desk—18", 22", or 28"

Pedestal ships with lock plugs keyed differently (KD). For keyed-alike locks on multiple pedestals, specify keyed alike (KA); separate lock plugs are shipped and field installed on each pedestal. See Keyed-Alike Information in Appendices.

Dimensions

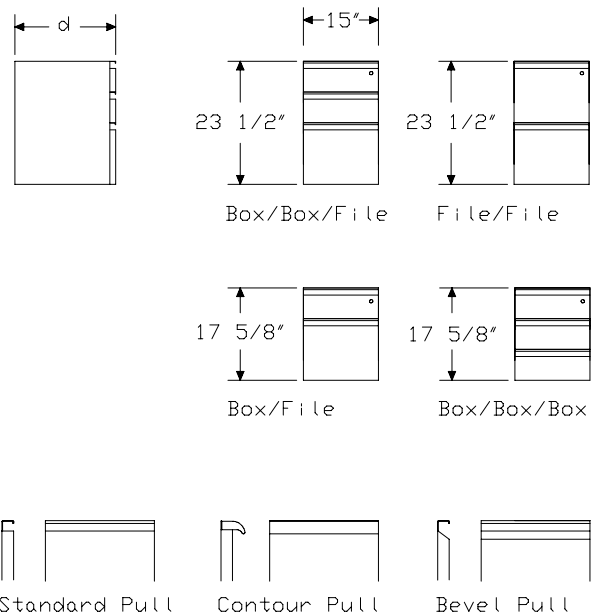

Suspended Pedestal with Standard, Contour, or Bevel Pull

continued

5000 Series Storage

Specification Information

Step 1.

R-

Step 2. Pull/Front Style

6-15	standard pull with painted front	
R-15	standard pull with recut veneer front	A
F-15	standard pull with wood veneer front	A
5-15	contour pull	
4-15	bevel pull	

Step 3. Depth

18-	18" deep
22-	22" deep
28-	28" deep

Step 4. Configuration

H	box/box/file
G	file/file
A	box/file
B	box/box/box

Prices for Steps 1-4.

		H	G	A	B
R-6-15	18-	\$576	548	456	561
	22-	\$591	563	464	575
	28-	\$606	578	479	585
R-R-15	18-	\$822	795	658	764
	22-	\$837	810	669	778
	28-	\$853	825	682	789
R-F-15	18-	\$833	807	671	778
	22-	\$850	823	681	789
	28-	\$866	836	695	802
R-5-15	18-	\$699	639	540	685
	22-	\$714	655	552	697
	28-	\$734	673	564	707
R-4-15	18-	\$576	548	456	561
	22-	\$591	563	464	575
	28-	\$606	578	479	585

Step 5. Steel Type

SS	smooth paint on smooth steel	+\$0
TS	smooth paint on textured steel	+\$0

Step 6. Surface Finish

See Finish Colors list for paint codes.

Nonmetallic Paint	+\$0
Metallic Paint	+\$40

Step 7. Pull Type

For contour pull (5-15)

1P	painted	+\$0
1S	stained A	+\$0

Step 8. Pull Finish

See Finish Colors list for paint codes.

For painted (1P)

Nonmetallic Paint	+\$0
Metallic Paint	+\$0

Solid Woods

For stained (1S)

V3	cherry A	+\$0
Z3	warm red cherry A	+\$0
Z5	maple A	+\$0
ED	aged cherry A	+\$10
EG	medium brown walnut A	+\$10
EK	medium red walnut A	+\$10
EY	light anigre A	+\$10
UL	natural maple A	+\$10
UQ	light cherry A	+\$10
UV	red cherry A	+\$10
UX	walnut on cherry A	+\$10

Step 9. Front Finish

Recut Veneer

For standard pull with recut veneer front (R-15)

RA	light ash A	+\$0
RK	mahogany dark A	+\$0
RM	mahogany A	+\$0

Suspended Pedestal with Standard, Contour, or Bevel Pull

continued

5000 Series Storage

Wood Veneer

For standard pull with wood veneer front (F-15)

V3	cherry <input type="checkbox"/> A	+\$0
Z3	warm red cherry <input type="checkbox"/> A	+\$0
Z5	maple <input type="checkbox"/> A	+\$0
ED	aged cherry <input type="checkbox"/> A	+\$35
EG	medium brown walnut <input type="checkbox"/> A	+\$35
EK	medium red walnut <input type="checkbox"/> A	+\$35
EY	light anigre <input type="checkbox"/> A	+\$35
UL	natural maple <input type="checkbox"/> A	+\$35
UQ	light cherry <input type="checkbox"/> A	+\$35
UV	red cherry <input type="checkbox"/> A	+\$35
UX	walnut on cherry <input type="checkbox"/> A	+\$35

Step 10. Lock

KD	keyed differently with black lock	+\$0
KC	keyed differently with chrome lock	+\$0
KA	keyed alike	+\$0

Suspended Pedestal with B- or F-Pull

R-X-1
R-Y-1

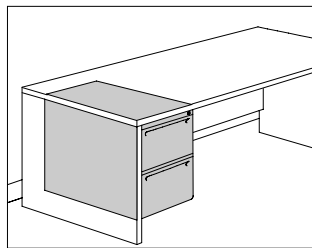

Product Information

Description

This lockable suspended pedestal mounts under a 5000 Series desk component and has a choice of pull and front styles (see chart below). Box drawers have 1 drawer divider. File drawers hold letter-size front-to-back hanging files; they also include 2 file converters for legal-size hanging files. The pedestal has a B or F pull. B-pull box drawers have full-extension steel ball-bearing slides; F-pull box drawers have 3/4-extension roller slides. File drawers have full-extension steel ball-bearing slides.

Pull Style—Pull Material—Front Style

F-pull—Plastic pull—Metal front

B-pull—Plastic pull—Plastic front

Notes

Pedestals on each side of desk should be the same height.

Pedestals with standard, bevel, and contour pulls are 3/8" wider than pedestals with B and F pulls. Drawer accessories for pedestals with standard, bevel, and contour pulls are not interchangeable with accessories for pedestals with B and F pulls.

To determine pedestal size that fits under desk surface, refer to following chart:

Surface Depth—Pedestal Depth

24" return—20"

30" return—20", 24", or 28"

30" desk—20" or 24"

36" desk—20", 24", or 28"

Pedestal ships with lock plugs keyed differently (KD). For keyed-alike locks on multiple pedestals, specify keyed alike (KA); separate lock plugs are shipped and field installed on each pedestal. See Keyed-Alike Information in Appendices.

Dimensions

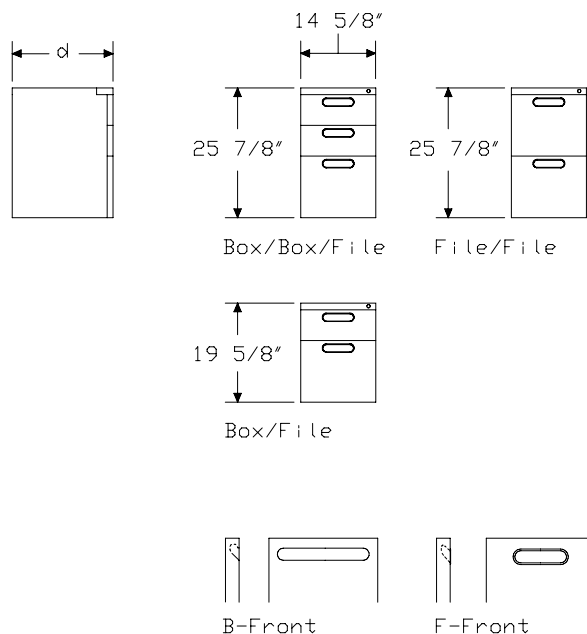

5000 Series Storage

Suspended Pedestal with B- or F-Pull *continued*

5000 Series Storage

Specification Information

Step 1.

R-

Step 2. Pull/Front Style

X-15 B-pull

Y-15 F-pull

Step 3. Depth

20- 20" deep

24- 24" deep

28- 28" deep

Step 4. Configuration

H box/box/file

G file/file

A box/file

Prices for Steps 1-4.

	H	G	A
R-X-15 20-	\$530	505	419
24-	\$544	519	429
28-	\$559	532	440

R-Y-15 20-	\$473	451	374
24-	\$484	462	382
28-	\$499	475	392

Step 5. Steel Type

SS smooth paint on smooth steel +\$0

Step 6. Surface Finish

For B-pull (X-15)

8Q folkstone grey +\$0

BU black umber +\$0

HF inner tone light +\$0

LT light tone +\$0

LU soft white +\$0

MT medium tone +\$0

SG slate grey +\$0

WL sandstone +\$0

For F-pull (Y-15)

8Q folkstone grey +\$0

BU black umber +\$0

HF inner tone light +\$0

LT light tone +\$0

LU soft white +\$0

MT medium tone +\$0

SG slate grey +\$0

WL sandstone +\$0

CN metallic champagne +\$40

EH metallic bronze +\$40

MS metallic silver +\$40

Step 7. Lock

KD keyed differently with black lock +\$0

KA keyed alike +\$0

Drawer Divider for Box Drawer,
Meridian® Pedestal

73-15
73-18

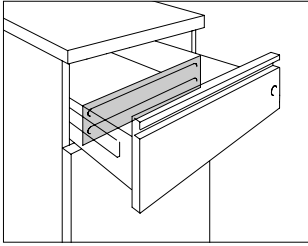

Product Information

Description

This adjustable divider is used in a box drawer. The 12"-wide divider fits in a 15"-wide box drawer; the 15"-wide divider fits in an 18"-wide box drawer. Finish is black umber.

Notes

Drawer divider cannot be used in Tu™ pedestals or Quadrant® pedestals. For 5000 Series furniture, drawer divider can be used in standard-, bevel-, or contour-pull pedestals.

Dimensions

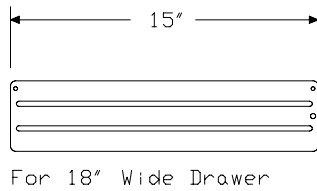
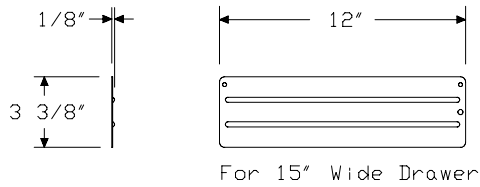

Specification Information

Step 1.

73-

Step 2. Width

1567-D for 15"-wide drawer (for Meridian® pedestals and 5000 Series furniture)

1867-D for 18"-wide drawer (for Meridian pedestals)

Prices for Steps 1-2.

73-1567-D	\$12
73-1867-D	\$15

5000 Series Storage

Stationery Tray for Box Drawer,
Meridian® Pedestal

73-70

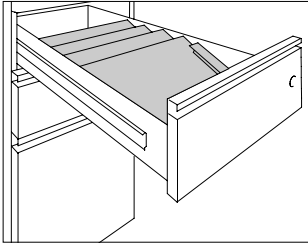

5000 Series Storage

Product Information

Description

This sectioned tray stores envelopes, stationery, and forms in a box drawer. The 12"-wide tray fits in a 15"-wide box drawer; the 15"-wide tray fits in an 18"-wide box drawer. Finish is black umber.

Notes

Stationery tray cannot be used in Tu™ pedestals or Quadrant® pedestals. For 5000 Series furniture, stationery tray can be used in standard-, bevel-, or contour-pull pedestals.

Dimensions

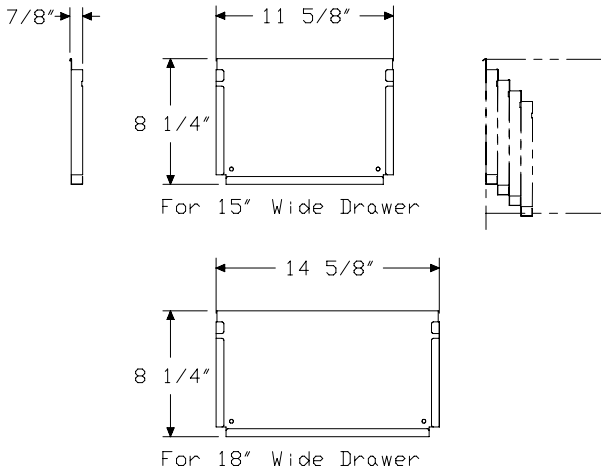

Specification Information

Step 1.

73-7082-

Step 2. Width

SST for 15"-wide drawer (for Meridian® pedestals and 5000 Series furniture)

SST-SP for 18"-wide drawer (for Meridian pedestals)

Prices for Steps 1-2.

73-7082- SST	\$75
SST-SP	\$85

Pencil Tray for Box Drawer,
Meridian® Pedestal

73-15
73-18

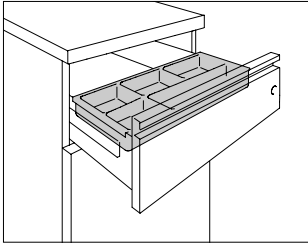

Product Information

Description

This plastic drawer stores pencils and other small items in a box drawer. The 12"-wide pencil tray fits in a 15"-wide box drawer; the 15"-wide pencil tray fits in an 18"-wide box drawer. Finish is black umber.

Notes

Pencil tray cannot be used in Tu™ pedestals or Quadrant® pedestals. For 5000 Series furniture, pencil tray can be used in standard-, bevel-, or contour-pull pedestals.

Dimensions

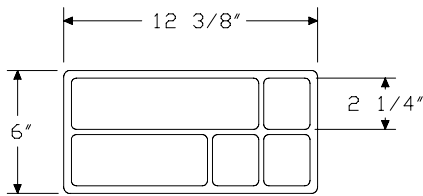
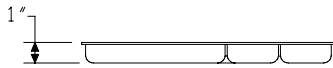

For 15" Wide Drawers

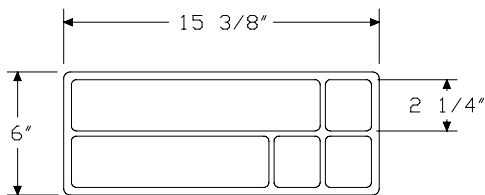

For 18" Wide Drawers

Specification Information

Step 1.

73-

Step 2. Width

1516-PT for 15"-wide drawer (for Meridian® pedestals and 5000 Series furniture)

1816-PT for 18"-wide drawer (for Meridian pedestals)

Prices for Steps 1-2.

73-1516-PT	\$19
73-1816-PT	\$22

File Drawer Organizer, Meridian® 73-98
Pedestal

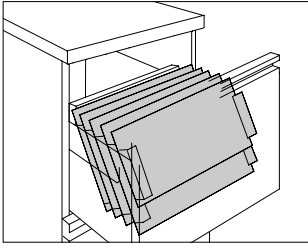

5000 Series Storage

Product Information

Description

This sectioned organizer stores letter-size stationery and papers in a file drawer. The 12"-wide organizer fits in a 15"-wide file drawer; the 15"-wide organizer fits in an 18"-wide file drawer. Finish is black umber.

Notes

File drawer organizer cannot be used in Tu™ pedestals or Quadrant® pedestals.

For 5000 Series furniture, file drawer organizer can be used in standard-, bevel-, or contour-pull pedestals.

Dimensions

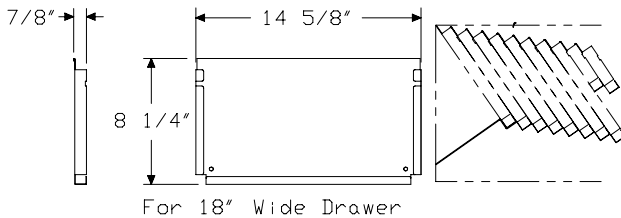
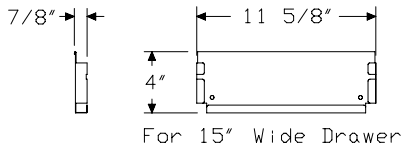

Specification Information

Step 1.

73-9874-

Step 2. Width

FDO for 15"-wide drawer (for Meridian® pedestals and 5000 Series furniture)

FDO-SP for 18"-wide drawer (for Meridian pedestals)

Prices for Steps 1-2.

73-9874-	FDO	\$135
	FDO-SP	\$163

File Drawer Organizer

LG901

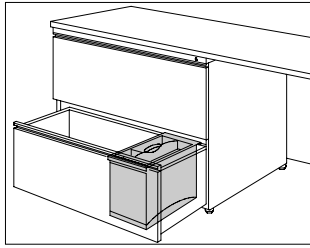

Product Information

Description

This 2-sectioned organizer fits into any file drawer arranged for letter-size filing. The removable top section stores computer disks and other small items. The bottom section stores larger items or can be divided into 3 compartments; it includes 2 vertical dividers. Finish is black umber.

Dimensions

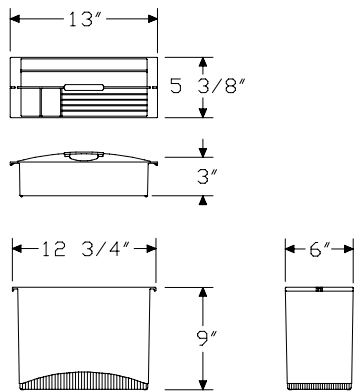

Specification Information

Step 1.

LG901

\$62

5000 Series Storage

Drawer Divider, Tu™ Pedestal

LG903.

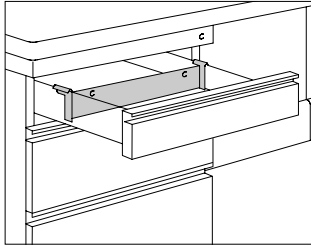

5000 Series Storage

Product Information

Description

This adjustable divider is used in a pencil or box drawer. Finish is black umber.

Notes

Divider can be used in the following products:

- 5000 Series furniture with B- and F-pull pedestals
- Tu™ Q-, R-, T-, V-, and W-pull pedestals
- Tu storage towers

Dimensions

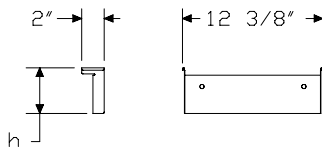

Specification Information

Step 1.

LG903.

Step 2. Usage

- 3** for pencil drawer
- 6** for box drawer

Prices for Steps 1-2.

LG903. 3	\$11
6	\$12

Stationery Divider, Tu™ Pedestal LG905

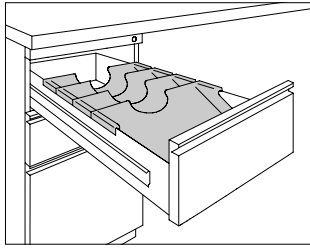

Product Information

Description

These 4 removable dividers are used in box drawers. Finish is black umber.

Notes

Dividers can be used in the following products:

- 5000 Series furniture with B- and F-pull pedestals
- Tu™ Q-, R-, T-, V-, and W-pull pedestals
- Tu storage towers

Dimensions

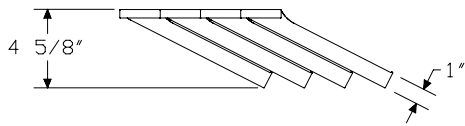

Specification Information

Step 1.

LG905

\$39

Utility Tray, Tu™ Pedestal

LG906

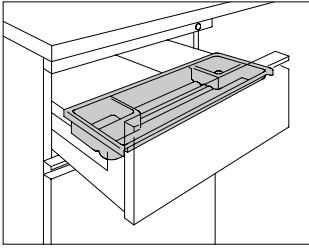

Product Information

Description

This sectioned tray stores pencils and small items in a pencil or box drawer. Finish is black umber.

Notes

Tray can be used in the following products:

- 5000 Series furniture with B- and F-pull pedestals
- Tu™ Q-, R-, T-, V-, and W-pull pedestals
- Tu storage towers

Dimensions

Specification Information

Step 1.

LG906

\$16

5000 Series Storage

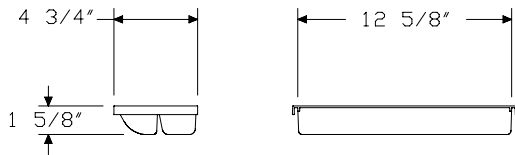

File Converter, Tu™ Pedestal

LG907

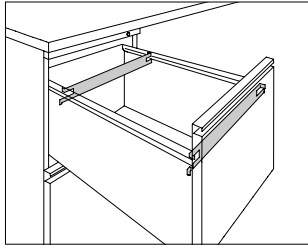

Product Information

Description

These black umber bars convert a file drawer to hold letter-, legal-, and A4-size side-to-side hanging files. 2 converters are used per drawer. Package contains 4.

Notes

- Converters can be used in the following products:
- 5000 Series furniture with B- and F-pull pedestals
 - Tu™ Q-, R-, T-, V-, and W-pull pedestals
 - Tu storage towers

Dimensions

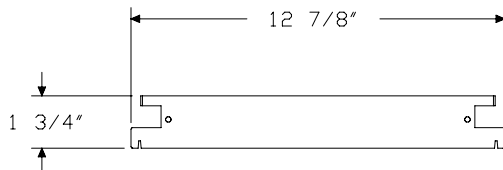

Specification Information

Step 1.

LG907

\$24

5000 Series Storage

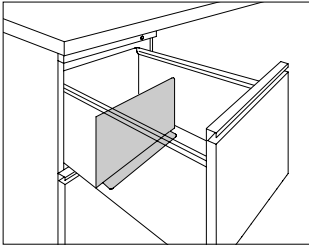

5000 Series Storage

Product Information

Description

These compressors lock into slots in the bottom of a pedestal file drawer to divide non-hanging files. Finish is black umber. Package contains 4.

Notes

Compressors can be used in the following products:

- 5000 Series furniture with B- and F-pull pedestals
- Tu™ Q-, R-, T-, V-, and W-pull pedestals
- Tu storage towers

Dimensions

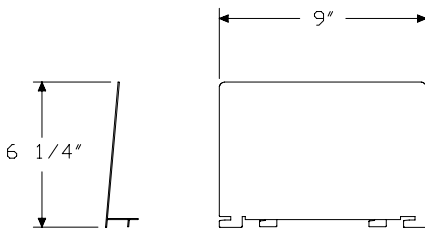

Specification Information

Step 1.

LG908

\$39

File Drawer Organizer

LG901

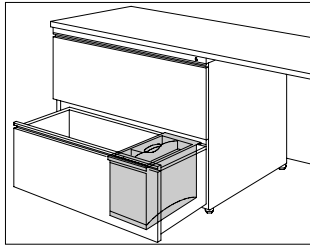

Product Information

Description

This 2-sectioned organizer fits into any file drawer arranged for letter-size filing. The removable top section stores computer disks and other small items. The bottom section stores larger items or can be divided into 3 compartments; it includes 2 vertical dividers. Finish is black umber.

Dimensions

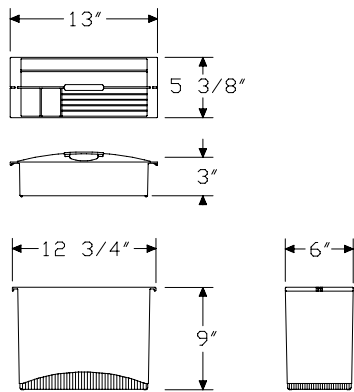

Specification Information

Step 1.

LG901

\$62

5000 Series Storage

Desk-Mounted Tackboard

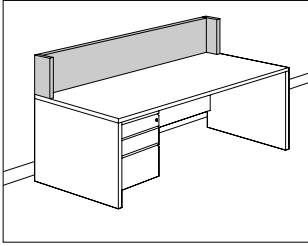

5000 Series Display Components

Product Information

Description

This 24"-high tackboard attaches to the back of a 5000 Series desk to display notes, photographs, or art. It has a fabric surface, steel end panels, and a steel back panel. Attachment hardware is included.

Notes

Fabric-covered tackboard accepts Customer's Own Material (COM). Yardage is estimated for directional, 54"-wide fabrics.

Width—Yardage

24" — 1
30" — 1 ¹ / ₈
36" — 1 ¹ / ₄
42" — 1 ¹ / ₂
48" — 1 ³ / ₅
60" — 2 ¹ / ₄
66" — 2 ¹ / ₂
72" — 2 ¹ / ₂

For information on multiple quantities or directional fabrics, contact COM Department. See Order Information in Appendices.

Dimensions

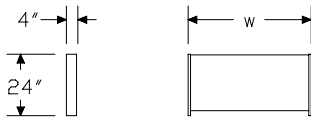

Specification Information

Step 1.

5-

Step 2. Width

2424-DMT 24" wide	\$338
3024-DMT 30" wide	\$364
3624-DMT 36" wide	\$392
4224-DMT 42" wide	\$418
4824-DMT 48" wide	\$445
6024-DMT 60" wide	\$485
6624-DMT 66" wide	\$514
7224-DMT 72" wide	\$540

Step 3. Steel Type

SS smooth paint on smooth steel	+\$0
TS smooth paint on textured steel	+\$0

Step 4. End/Back Panel Finish

See *Finish Colors list for paint codes.*

Nonmetallic Paint	+\$0
Metallic Paint	+\$15

Step 5. Fabric

See *application chart and textiles list for fabric usage and numbers. First 2 digits of number indicate fabric line; remaining digit(s) indicate fabric color.*

Price Category 1	+\$0
Price Category 2	+\$10
Price Category 3	+\$50
Price Category 4	+\$79
Price Category B	+\$59
Price Category C	+\$88
Price Category D	+\$117
Price Category E	+\$147
Price Category F	+\$203

Desk-Mounted Tool Rail with Tackboard

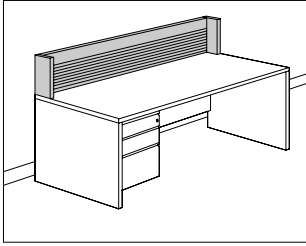

Product Information

Description

This 24"-high tool rail with tackboard attaches to a 5000 Series desk to hold work tools. It has steel end panels and a steel back panel and includes a 5³/₄"-high fabric tackboard at the top.

Notes

For accessory product applications, the following Compatibility Charts are available electronically for viewing and printing in Kiosk and HermanMiller.com: Keyboard Compatibility Charts, Pencil Drawer Compatibility Charts, and Work Organizer Compatibility Chart.

Fabric-covered tackboard accepts Customer's Own Material (COM).

Yardage is estimated for directional, 54"-wide fabrics.

Width—Yardage

30" — 1¹/₈

36" — 1¹/₄

42" — 1¹/₂

48" — 1³/₅

60" — 2¹/₄

66" — 2¹/₂

72" — 2¹/₂

For information on multiple quantities or directional fabrics, contact COM Department. See Order Information in Appendices.

Dimensions

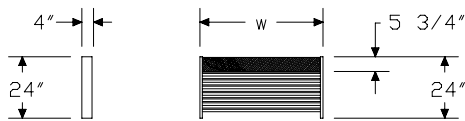

Specification Information

Step 1.

5-

Step 2. Width

3024-DMR	30" wide	\$505
3624-DMR	36" wide	\$552
4224-DMR	42" wide	\$583
4824-DMR	48" wide	\$615
6024-DMR	60" wide	\$685
6624-DMR	66" wide	\$719
7224-DMR	72" wide	\$763

Step 3. Steel Type

SS	smooth paint on smooth steel	+\$0
TS	smooth paint on textured steel	+\$0

Step 4. End/Back Panel/Door/Tool Rail Finish

See *Finish Colors list* for paint codes.

Nonmetallic Paint	+\$0
Metallic Paint	+\$35

Step 5. Tackboard Fabric

See *application chart and textiles list* for fabric usage and numbers. First 2 digits of number indicate fabric line; remaining digit(s) indicate fabric color.

Price Category 1	+\$0
Price Category 2	+\$5
Price Category 3	+\$25
Price Category 4	+\$40
Price Category B	+\$32
Price Category C	+\$47
Price Category D	+\$63
Price Category E	+\$78
Price Category F	+\$108

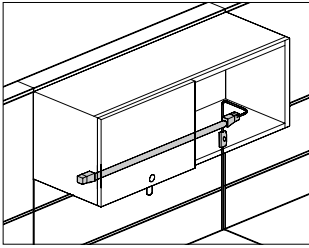

Product Information

Description
 This light mounts under a flipper door unit, storage unit, shelf or any other surface to light the work area. It has an aluminum extruded housing, poly-carbonate lens, and 2 linear light-emitting diodes (LED). The light can be rotated 45 degrees forward and backward by the user to direct light where desired. The LEDs consume 9.5 watts of power. The light has an 11' cord and is UL listed, UL Canada listed, and CSA certified. Attachment hardware and adhesive cord clips included.

Notes

Specify magnetic attachment option (M) for attaching the light to any metal surface. Specify bracket attachment option (B) for attaching the light to a wood or wood composite surface.
 Starter unit (B) is designed for use as a daisy chain with up to 3 add-on units (C).
 Multiple lights can be specified for use under 48"- and 60"-wide storage units/shelves.
 Light meets local codes for Canada, New York City, and Chicago.

Dimensions

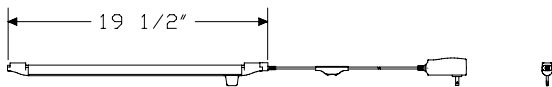

Specification Information

Step 1.

G6160. A

Step 2. Type

- A** single unit A
- B** starter unit A
- C** add-on unit A

Step 3. Attachment Method

- M** magnet attachment A
- B** bracket attachment A

Prices for Steps 1-3.

	M	B
G6160. A	\$369	369
B	\$445	445
C	\$320	320

Performance Task Light

G6114.
G6115.
G6116.
G6117.

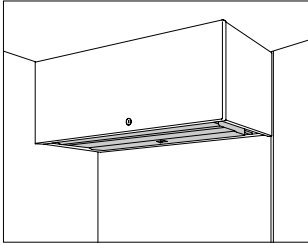

Product Information

Description

This light mounts under a flipper door unit, sliding door storage unit, shelf, transaction surface, or Corian® counter top to light the work area. It has a normal-power-factor electronic ballast or a high-power-factor electronic ballast, T5 lamp with a 3500° Kelvin color temperature, and a K-25 batwing lens. All lights are UL listed for USA and Canada. Mounting hardware and 3 cord management clips are included.

The 60"-wide light can be specified only with a 60"-wide flipper door unit or shelf; smaller lights cannot mount under 60"-wide storage products.

The task light has the following widths:

Width—Actual Width—Application

24"—13"—24"-wide storage

30"—24"—30"- or 36"-wide storage

42"—35"—42"- or 48"-wide storage

60"—46"—60"-wide storage

The daisy-chain system allows a run of lights to be operated from a single power source. A series of add-on lights is plugged into 1 starter light to operate up to 10 lights from a single outlet; each light has an independent on/off switch.

The daisy-chain add-on lights have the following cord lengths:

Light Width—Cord Length

24", 30", and 42"—42"

60"—78"

Notes

24"-wide light has a T5 lamp with a 4100° Kelvin color temperature.

For 5000 Series product applications, order cable manager (part # UMLo2F) separately.

Dimensions

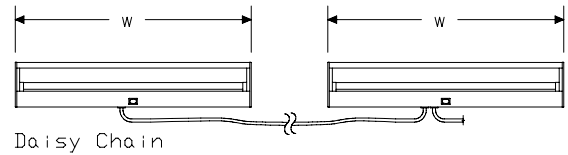
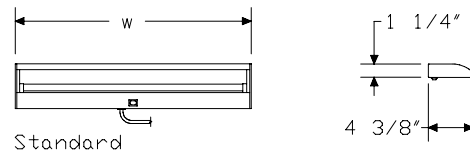

Performance Task Light *continued*

Specification Information

Step 1.

G611

Step 2. Type/Code Requirements

- 4. standard and meets local codes including Canada and New York City
- 5. standard and meets Chicago codes
- 6. daisy chain starter and meets local codes including Canada
- 7. daisy chain add-on and meets local codes including Canada

Step 3. Width

- 24** 24" wide
- 30** 30" wide
- 42** 42" wide
- 60** 60" wide

Step 4. Ballast

For 24" wide (24)

- E** normal-power-factor ballast

For 30" wide (30), 42" wide (42), or 60" wide (60)

- E** normal-power-factor ballast
- H** high-power-factor ballast

Step 5. Dimmer

- N** no dimmer

Step 6. Attachment Bracket

For standard and meets local codes including Canada and New York City (4.) or standard and meets Chicago codes (5.)

- S** for Action Office®, Prospects®, or Ethospace® Systems or Vivo® Interiors
- Q** for C-style storage or E3234.
- P** for Passage® Desking System
- F** for 5000 Series Furniture
- T** for transaction surface/counter top

For daisy chain starter and meets local codes including Canada (6.) or daisy chain add-on and meets local codes including Canada (7.)

- S** for Action Office®, Prospects®, or Ethospace® Systems or Vivo® Interiors
- Q** for C-style storage or E3234.
- P** for Passage® Desking System
- F** for 5000 Series Furniture

Prices for Steps 1-6.

	NS	NQ	NP	NF	NT
G6114. 24 E	\$260	260	260	260	260
30 E	\$270	270	270	270	270
H	\$388	388	388	388	388
42 E	\$291	291	291	291	291
H	\$418	418	418	418	418
60 E	\$323	323	323	323	323
H	\$457	457	457	457	457
G6115. 24 E	\$298	298	298	298	298
30 E	\$312	312	312	312	312
H	\$436	436	436	436	436
42 E	\$328	328	328	328	328
H	\$475	475	475	475	475
60 E	\$366	366	366	366	366
H	\$512	512	512	512	512
G6116. 24 E	\$386	386	386	386	—
30 E	\$405	405	405	405	—
H	\$524	524	524	524	—
42 E	\$442	442	442	442	—
H	\$555	555	555	555	—
60 E	\$477	477	477	477	—
H	\$593	593	593	593	—
G6117. 24 E	\$345	345	345	345	—
30 E	\$356	356	356	356	—
H	\$492	492	492	492	—
42 E	\$393	393	393	393	—
H	\$511	511	511	511	—
60 E	\$429	429	429	429	—
H	\$559	559	559	559	—

Performance Task Light *continued*

Step 7. Surface Finish

91	white	+\$0
BU	black umber	+\$0
CL	cool grey neutral	+\$0
G1	graphite	+\$0
HF	inner tone light	+\$0
LT	light tone	+\$0
LU	soft white	+\$0
MT	medium tone	+\$0
SG	slate grey	+\$0
WN	warm grey neutral	+\$0
CN	metallic champagne	+\$15
EH	metallic bronze	+\$15
MS	metallic silver	+\$15

Utility Task Light

G6136.
G6137.

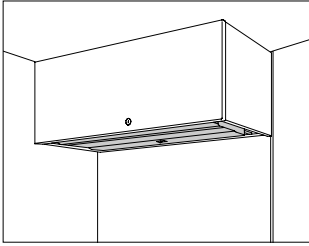

5000 Series Lighting

Product Information

Description

This light mounts under a flipper door unit, sliding door storage unit, shelf, transaction surface, or Corian® counter top to light the work area. It has a normal-power-factor electronic ballast, T5 lamp with a 3500° Kelvin color temperature, and prismatic lens. All lights are UL listed for USA and Canada. Mounting hardware and 3 cord management clips are included. Finish is black.

The 60"-wide light can be specified only with a 60"-wide flipper door unit or shelf; smaller lights cannot mount under 60"-wide storage products.

The task light has the following unit widths:

Width—Actual Width—Application

24"—13"—24"-wide storage

30"—24"—30"- or 36"-wide storage

42"—35"—42"- or 48"-wide storage

60"—46"—60"-wide storage

Notes

24"-wide light has a T5 lamp with a 4100° Kelvin color temperature.

For 5000 Series product applications, order cable manager (part # UMLo2F) separately.

Dimensions

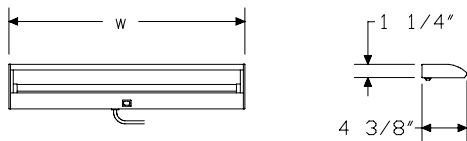

Specification Information

Step 1.

G613

Step 2. Code Requirements

- 6. meets local codes including Canada and New York City
- 7. meets Chicago codes

Step 3. Width

- 24 24" wide
- 30 30" wide
- 42 42" wide
- 60 60" wide

Step 4. Attachment Bracket

- S** for Action Office®, Prospects®, or Ethospace® Systems or Vivo® Interiors
- Q** for C-style storage or E3234.
- P** for Passage® Desking System
- F** for 5000 Series Furniture
- T** for transaction surface/counter top

Prices for Steps 1-4.

	S	Q	P	F	T
G6136. 24	\$188	188	188	188	188
30	\$191	191	191	191	191
42	\$211	211	211	211	211
60	\$234	234	234	234	234
G6137. 24	\$253	253	253	253	253
30	\$257	257	257	257	257
42	\$276	276	276	276	276
60	\$301	301	301	301	301

Desk with Single Pedestal, L Style

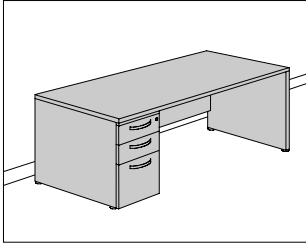

Product Information

Description

This desk connects to a 5000 Series L-style desk component or stands alone. It has 1 lockable support pedestal with 1" adjustable glides, Q pulls, and a choice of front styles. Box drawers have 1 drawer divider and full-extension steel ball-bearing slides. File drawers hold letter-size front-to-back hanging files and include 2 file converters for legal-size filing. File drawers have full-extension steel ball-bearing slides.

The desk has a laminate top and vinyl edge or a veneer top and edge and is available with or without grommets. A grommet is not available on the pedestal side of the desk. The desk has full or 10"-deep recessed end panels and 1" adjustable glides. 24"-deep desks with recessed end panels have a cable management cutout at the back of the panel. The desk is available with a raised or open back panel. The raised back panel is 8 1/8" from the floor and provides access to electrical components in panel system raceways; the open back panel is used against architectural walls or panel systems and provides maximum access to electrical/data outlets, including those complying with ADA standards. The open back panel includes a horizontal support rail; the bottom of the support rail is 8 1/8" from the floor.

The 24"-deep desk has a 24"-deep pedestal; the 30"-deep desk has a 24"- or 28"-deep pedestal; and the 36"-deep desk has a 28"-deep pedestal.

Actual desk depths are:

Depth—Actual

24" — 23.65"

30" — 28.15"

36" — 32.40"

Notes

36"-deep desks and 30"-deep desks with 24"-deep pedestals have back panel recessed 4 1/2" from visitor's side.

To use desk freestanding, order with full end panels. To connect desk to a 5000 Series L-style component, 1 recessed end panel may be required.

Order optional desk components separately:

- L-style bridge
- L-style return with single pedestal

To manage cables under desk, order cable management trough separately.

Order optional display or storage components separately:

- Desk-mounted tackboard
- Desk-mounted tool rail with tackboard
- End-mounted tackboard
- Flipper door unit

For accessory product applications, the following Compatibility Charts are available electronically for viewing and printing in Kiosk and HermanMiller.com: Keyboard Compatibility Charts, Pencil Drawer Compatibility Charts, and Work Organizer Compatibility Chart.

Pedestal ships with lock plugs keyed differently (KD). For keyed-alike locks on multiple pedestals, specify keyed alike (KA); separate lock plugs are shipped and field installed on each pedestal. See Keyed-Alike Information in Appendices.

Dimensions

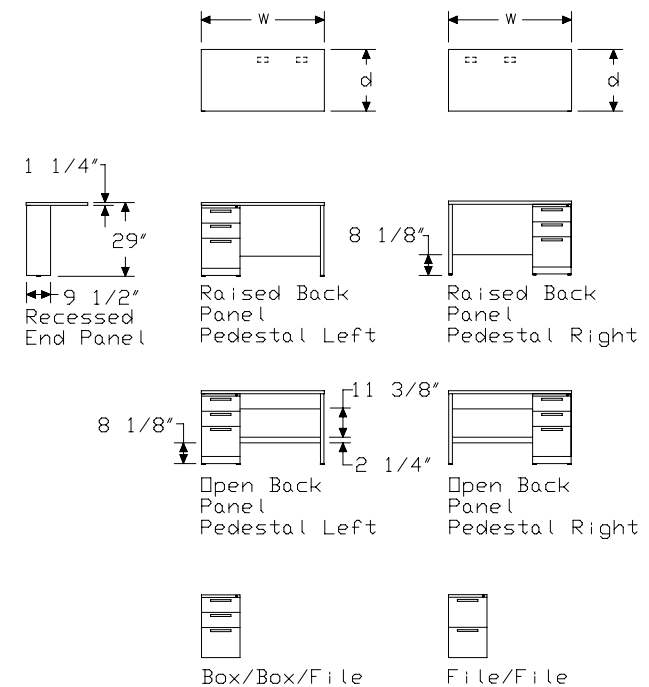

5000 Series L-Style Products

Desk with Single Pedestal, L Style

continued

5000 Series L-Style Products

Specification Information		
Step 1.		
5L		
Step 2. Back Panel		
P	open back panel	\$0
R	raised back panel	\$0
Step 3. Pedestal Pull/Front Style		
Q-	Q-pull	+\$100
Step 4. Width		
60	60" wide	+\$0
66	66" wide	+\$0
72	72" wide	+\$0
Step 5. Depth		
<i>For 60" wide (60)</i>		
2424-	24" deep with 24" deep pedestal	+\$729
3024-	30" deep with 24" deep pedestal	+\$748
3028-	30" deep with 28" deep pedestal	+\$773
3628-	36" deep with 28" deep pedestal	+\$824
<i>For 66" wide (66)</i>		
2424-	24" deep with 24" deep pedestal	+\$763
3024-	30" deep with 24" deep pedestal	+\$774
3028-	30" deep with 28" deep pedestal	+\$824
3628-	36" deep with 28" deep pedestal	+\$886
<i>For 72" wide (72)</i>		
2424-	24" deep with 24" deep pedestal	+\$797
3024-	30" deep with 24" deep pedestal	+\$836
3028-	30" deep with 28" deep pedestal	+\$886
3628-	36" deep with 28" deep pedestal	+\$999
Step 6. Configuration (from User Side)		
GL	file/file left, full end panel right	+\$165
GS	file/file left, recessed end panel right	+\$165
LG	full end panel left, file/file right	+\$165
SG	recessed end panel left, file/file right	+\$165
HL	box/box/file left, full end panel right	+\$175
HS	box/box/file left, recessed end panel right	+\$175
LH	full end panel left, box/box/file right	+\$175
SH	recessed end panel left, box/box/file right	+\$175

Step 7. Paint/Steel Type		
SS	smooth paint on smooth steel	+\$0

Step 8. Understructure Finish		
8Q	folkstone grey	+\$0
BU	black umber	+\$0
HF	inner tone light	+\$0
LT	light tone	+\$0
LU	soft white	+\$0
MT	medium tone	+\$0
SG	slate grey	+\$0
WL	sandstone	+\$0
CN	metallic champagne	+\$90
EH	metallic bronze	+\$90
MS	metallic silver	+\$90

Step 9. Pull Finish		
BW	warm bronze	+\$0
NH	brushed nickel	+\$0
NK	black nickel	+\$0

Step 10. Top				
		60	66	72
TL	lamine top with vinyl edge	+\$0	0	0
TR	recut veneer top <input type="checkbox"/> A	+\$378	390	403
TF	wood veneer top <input type="checkbox"/> A	+\$446	460	473

Step 11.		
----------	--	--

Top Finish: Solid-Color Laminate		
<i>For laminate top with vinyl edge (TL)</i>		
8Q	folkstone grey	+\$0
91	white	+\$0
CL	cool grey neutral	+\$0
HF	inner tone light	+\$0
HT	inner tone	+\$0
LT	light tone	+\$0
LU	soft white	+\$0
WL	sandstone	+\$0
WN	warm grey neutral	+\$0

Desk with Single Pedestal, L Style

continued

Top Finish: Fiber Laminate

For laminate top with vinyl edge (TL)

1X	vanilla	+\$0
2X	wheat	+\$0
3X	celery	+\$0
4X	coriander	+\$0
5X	chamomile	+\$0
6X	cinnamon	+\$0
7X	cardamom	+\$0
8X	kale	+\$0

Top Finish: Frosted Laminate

For laminate top with vinyl edge (TL)

J4	frosted light grey	+\$0
J5	frosted inner tone light	+\$0
J6	frosted slate grey	+\$0
J7	frosted medium tone	+\$0
J8	frosted black	+\$0

Top/Edge Finish: Recut Veneer

For recut veneer top (TR)

RA	light ash <input type="checkbox"/>	+\$0
RK	mahogany dark <input type="checkbox"/>	+\$0
RM	mahogany <input type="checkbox"/>	+\$0

Top/Edge Finish: Wood Veneer

For wood veneer top (TF)

V3	cherry <input type="checkbox"/>	+\$0
Z3	warm red cherry <input type="checkbox"/>	+\$0
Z5	maple <input type="checkbox"/>	+\$0
ED	aged cherry <input type="checkbox"/>	+\$20
UL	natural maple <input type="checkbox"/>	+\$20
UQ	light cherry <input type="checkbox"/>	+\$20
UV	red cherry <input type="checkbox"/>	+\$20
UX	walnut on cherry <input type="checkbox"/>	+\$20

Step 12. Edge Finish

For laminate top with vinyl edge (TL)

8Q	folkstone grey	+\$0
91	white	+\$0
BU	black umber	+\$0
CL	cool grey neutral	+\$0
CM	cinnamon	+\$0
CO	chamomile	+\$0
G2	graphite satin	+\$0
HF	inner tone light	+\$0
HT	inner tone	+\$0
LU	soft white	+\$0
MT	medium tone	+\$0
SG	slate grey	+\$0
WL	sandstone	+\$0
WN	warm grey neutral	+\$0

Step 13. Grommets

For file/file left, full end panel right (GL), file/file left, recessed end panel right (GS), box/box/file left, full end panel right (HL), or box/box/file left, recessed end panel right (HS)

NTG	no grommet	+\$0
C	grommet center	+\$27
R	grommet right	+\$27
2CR	grommets center and right	+\$53

For full end panel left, file/file right (LG), recessed end panel left, file/file right (SG), full end panel left, box/box/file right (LH), or recessed end panel left, box/box/file right (SH)

NTG	no grommet	+\$0
C	grommet center	+\$27
L	grommet left	+\$27
2LC	grommets left and center	+\$53

5000 Series L-Style Products

Desk with Single Pedestal, L Style

continued

Step 14. Grommet Finish

For grommet center (C), grommet left (L), grommet right (R), grommets center and right (2CR), or grommets left and center (2LC)

8Q	folkstone grey	+\$0
91	white	+\$0
BU	black umber	+\$0
CL	cool grey neutral	+\$0
HF	inner tone light	+\$0
LU	soft white	+\$0
MT	medium tone	+\$0
SG	slate grey	+\$0
WL	sandstone	+\$0
WN	warm grey neutral	+\$0

Step 15. Lock

KA	keyed alike	+\$0
KC	keyed differently, chrome	+\$0
KD	keyed differently, black	+\$0

Desk with Double Pedestal, L Style

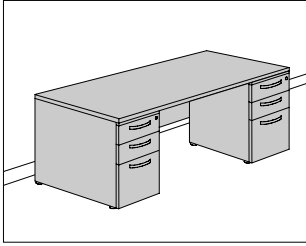

Product Information

Description

This freestanding desk has 2 lockable support pedestals with 1" adjustable glides, Q pulls, and a choice of front styles. Box drawers have 1 drawer divider and full-extension steel ball-bearing slides. File drawers hold letter-size front-to-back hanging files and include 2 file converters for legal-size filing. File drawers have full-extension steel ball-bearing slides.

The desk has a laminate top and vinyl edge or a veneer top and edge and is available with a center grommet or no grommet. It is available with a raised or open back panel. The raised back panel is 8 1/8" from the floor and provides access to electrical components in panel system raceways; the open back panel is used against architectural walls and provides maximum access to electrical/data outlets, including those complying with ADA standards. The open back panel includes a horizontal support rail; the bottom of the support rail is 8 1/8" from the floor.

The 24"-deep desk has 24"-deep pedestals; the 30"-deep desk has 24"- or 28"-deep pedestals; and the 36"-deep desk has 28"-deep pedestals.

Actual desk depths are:

Depth—Actual

24" — 23.65"

30" — 28.15"

36" — 32.40"

Notes

36"-deep desks and 30"-deep desks with 24"-deep pedestals have back panel recessed 4 1/2" from visitor's side.

To manage cables under desk, order cable management trough separately.

Order optional display or storage components separately:

- Desk-mounted tackboard
- Desk-mounted tool rail with tackboard
- End-mounted tackboard
- Flipper door unit

For accessory product applications, the following Compatibility Charts are available electronically for viewing and printing in Kiosk and HermanMiller.com: Keyboard Compatibility Charts, Pencil Drawer Compatibility Charts, and Work Organizer Compatibility Chart.

For keyed-alike desks, specify keyed alike (KA); separate lock plugs are shipped and field installed on each pedestal. See Keyed-Alike Information in Appendices.

For keyed differently locks on each pedestal in the same desk, contact Customer Care.

Dimensions

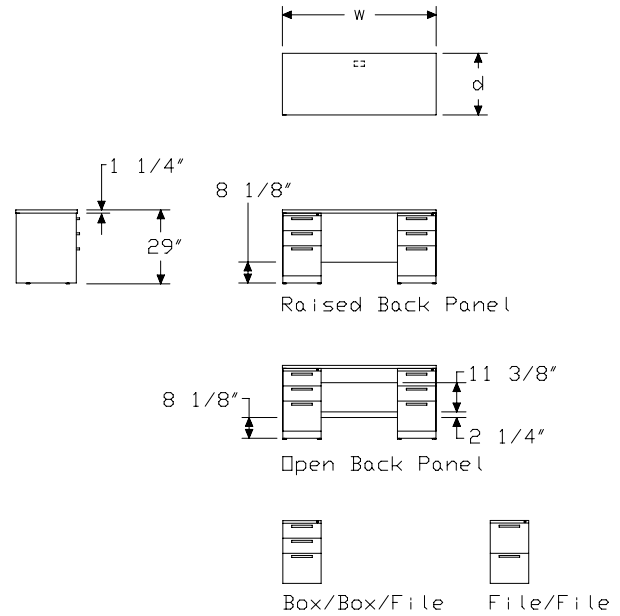

Desk with Double Pedestal, L Style *continued*

Specification Information		
Step 1.		
5L		
Step 2. Back Panel		
P	open back panel	\$0
R	raised back panel	\$0
Step 3. Pedestal Pull/Front Style		
Q-	Q-pull	+\$200
Step 4. Width		
60	60" wide	+\$0
66	66" wide	+\$0
72	72" wide	+\$0
Step 5. Depth		
<i>For 60" wide (60)</i>		
2424-	24" deep with 24" deep pedestal	+\$605
3024-	30" deep with 24" deep pedestal	+\$649
3028-	30" deep with 28" deep pedestal	+\$674
3628-	36" deep with 28" deep pedestal	+\$723
<i>For 66" wide (66)</i>		
2424-	24" deep with 24" deep pedestal	+\$649
3024-	30" deep with 24" deep pedestal	+\$688
3028-	30" deep with 28" deep pedestal	+\$713
3628-	36" deep with 28" deep pedestal	+\$787
<i>For 72" wide (72)</i>		
2424-	24" deep with 24" deep pedestal	+\$687
3024-	30" deep with 24" deep pedestal	+\$749
3028-	30" deep with 28" deep pedestal	+\$774
3628-	36" deep with 28" deep pedestal	+\$935
Step 6. Configuration (from User Side)		
GG	file/file left, file/file right	+\$330
GH	file/file left, box/box/file right	+\$340
HG	box/box/file left, file/file right	+\$340
HH	box/box/file left, box/box/file right	+\$350
Step 7. Paint/Steel Type		
SS	smooth paint on smooth steel	+\$0

Step 8. Understructure Finish		
8Q	folkstone grey	+\$0
BU	black umber	+\$0
HF	inner tone light	+\$0
LT	light tone	+\$0
LU	soft white	+\$0
MT	medium tone	+\$0
SG	slate grey	+\$0
WL	sandstone	+\$0
CN	metallic champagne	+\$120
EH	metallic bronze	+\$120
MS	metallic silver	+\$120

Step 9. Pull Finish		
BW	warm bronze	+\$0
NH	brushed nickel	+\$0
NK	black nickel	+\$0

Step 10. Top				
		60	66	72
TL	laminated top with vinyl edge	+\$0	0	0
TR	recut veneer top A	+\$378	390	403
TF	wood veneer top A	+\$446	460	473

Step 11.		
Top Finish: Solid-Color Laminate		
<i>For laminate top with vinyl edge (TL)</i>		
8Q	folkstone grey	+\$0
91	white	+\$0
CL	cool grey neutral	+\$0
HF	inner tone light	+\$0
HT	inner tone	+\$0
LT	light tone	+\$0
LU	soft white	+\$0
WL	sandstone	+\$0
WN	warm grey neutral	+\$0

Desk with Double Pedestal, L

Style *continued*

Top Finish: Fiber Laminate

For laminate top with vinyl edge (TL)

1X	vanilla	+\$0
2X	wheat	+\$0
3X	celery	+\$0
4X	coriander	+\$0
5X	chamomile	+\$0
6X	cinnamon	+\$0
7X	cardamom	+\$0
8X	kale	+\$0

Top Finish: Frosted Laminate

For laminate top with vinyl edge (TL)

J4	frosted light grey	+\$0
J5	frosted inner tone light	+\$0
J6	frosted slate grey	+\$0
J7	frosted medium tone	+\$0
J8	frosted black	+\$0

Top/Edge Finish: Recut Veneer

For recut veneer top (TR)

RA	light ash A	+\$0
RK	mahogany dark A	+\$0
RM	mahogany A	+\$0

Top/Edge Finish: Wood Veneer

For wood veneer top (TF)

V3	cherry A	+\$0
Z3	warm red cherry A	+\$0
Z5	maple A	+\$0
ED	aged cherry A	+\$20
UL	natural maple A	+\$20
UQ	light cherry A	+\$20
UV	red cherry A	+\$20
UX	walnut on cherry A	+\$20

Step 12. Edge Finish

For laminate top with vinyl edge (TL)

8Q	folkstone grey	+\$0
91	white	+\$0
BU	black umber	+\$0
CL	cool grey neutral	+\$0
CM	cinnamon	+\$0
CO	chamomile	+\$0
G2	graphite satin	+\$0
HF	inner tone light	+\$0
HT	inner tone	+\$0
LU	soft white	+\$0
MT	medium tone	+\$0
SG	slate grey	+\$0
WL	sandstone	+\$0
WN	warm grey neutral	+\$0

Step 13. Grommets

NTG	no grommet	+\$0
C	grommet center	+\$27

Step 14. Grommet Finish

For grommet center (C)

8Q	folkstone grey	+\$0
91	white	+\$0
BU	black umber	+\$0
CL	cool grey neutral	+\$0
HF	inner tone light	+\$0
LU	soft white	+\$0
MT	medium tone	+\$0
SG	slate grey	+\$0
WL	sandstone	+\$0
WN	warm grey neutral	+\$0

Step 15. Lock

KA	keyed alike	+\$0
KC	keyed differently, chrome	+\$0
KD	keyed differently, black	+\$0

Corner Desk, L Style

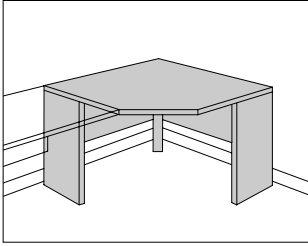

Product Information

Description

This straight-edged 90° corner desk connects to a 5000 Series L-style component or stands alone. It has a laminate top and vinyl edge or a veneer top and edge and is available with a center grommet or no grommet. The desk has full or 10"-deep recessed end panels and 1" adjustable glides. Desks with recessed end panels have a cable management cutout at the back of the panel. The desk is available with a raised or open back panel. The raised back panel is 8 1/8" from the floor and provides access to electrical components in panel system raceways; the open back panel is used against architectural walls or panel systems and provides maximum access to electrical/data outlets, including those complying with ADA standards. The open back panel includes a horizontal support rail; the bottom of the support rail is 8 1/8" from the floor.

Notes

To use corner desk at end of furniture run, specify full end panel.

Order optional desk components separately:

- L-style bridge
- L-style return with single pedestal

To manage cables under corner desk, order cable management trough separately.

Order optional display or storage components separately:

- Corner desk-mounted tackboard
- Flipper door unit

For accessory product applications, the following Compatibility Charts are available electronically for viewing and printing in Kiosk and HermanMiller.com: Keyboard Compatibility Charts, Pencil Drawer Compatibility Charts, and Work Organizer Compatibility Chart.

Dimensions

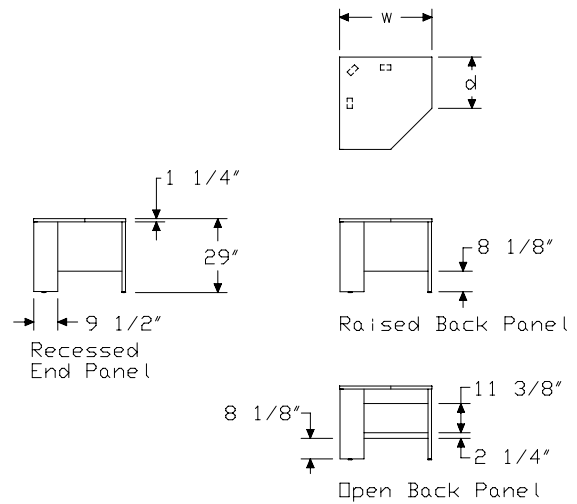

Corner Desk, L Style *continued*

Specification Information		
Step 1.		
5L		
Step 2. Back Panel		
P0-	open back panel	\$0
R0-	raised back panel	\$0
Step 3. Width/Depth		
424224-	42" wide x 24" deep	+\$887
Step 4. End Panels (from User Side)		
SS	recessed end panel left, recessed end panel right	+\$0
Step 5. Paint/Steel Type		
SS	smooth paint on smooth steel	+\$0
Step 6. Understructure Finish		
8Q	folkstone grey	+\$0
BU	black umber	+\$0
HF	inner tone laminate	+\$0
LT	light tone	+\$0
LU	soft white	+\$0
MT	medium tone	+\$0
SG	slate grey	+\$0
WL	sandstone	+\$0
CN	metallic champagne	+\$60
EH	metallic bronze	+\$60
MS	metallic silver	+\$60
Step 7. Top		
TL	laminate top with vinyl edge	+\$0
TR	recut veneer top <input type="checkbox"/> A	+\$329
TF	wood veneer top <input type="checkbox"/> A	+\$388

Step 8.		
Top Finish: Solid-Color Laminate		
<i>For laminate top with vinyl edge (TL)</i>		
8Q	folkstone grey	+\$0
91	white	+\$0
CL	cool grey neutral	+\$0
HF	inner tone laminate	+\$0
HT	inner tone	+\$0
LT	light tone	+\$0
LU	soft white	+\$0
WL	sandstone	+\$0
WN	warm grey neutral	+\$0
Top Finish: Fiber Laminate		
<i>For laminate top with vinyl edge (TL)</i>		
1X	vanilla	+\$0
2X	wheat	+\$0
3X	celery	+\$0
4X	coriander	+\$0
5X	chamomile	+\$0
6X	cinnamon	+\$0
7X	cardamom	+\$0
8X	kale	+\$0
Top Finish: Frosted Laminate		
<i>For laminate top with vinyl edge (TL)</i>		
J4	frosted light grey	+\$0
J5	frosted inner tone light	+\$0
J6	frosted slate grey	+\$0
J7	frosted medium tone	+\$0
J8	frosted black	+\$0
Top/Edge Finish: Recut Veneer		
<i>For recut veneer top (TR)</i>		
RA	light ash <input type="checkbox"/> A	+\$0
RK	mahogany dark <input type="checkbox"/> A	+\$0
RM	mahogany <input type="checkbox"/> A	+\$0

Corner Desk, L Style *continued*

5000 Series L-Style Products

Top/Edge Finish: Wood Veneer

For wood veneer top (TF)

V3	cherry <input type="checkbox"/> A	+\$0
Z3	warm red cherry <input type="checkbox"/> A	+\$0
Z5	maple <input type="checkbox"/> A	+\$0
ED	aged cherry <input type="checkbox"/> A	+\$30
UL	natural maple <input type="checkbox"/> A	+\$30
UQ	light cherry <input type="checkbox"/> A	+\$30
UV	red cherry <input type="checkbox"/> A	+\$30
UX	walnut on cherry <input type="checkbox"/> A	+\$30

Step 9. Edge Finish

For laminate top with vinyl edge (TL)

8Q	folkstone grey	+\$0
91	white	+\$0
BU	black umber	+\$0
CL	cool grey neutral	+\$0
CM	cinnamon	+\$0
CO	chamomile	+\$0
G2	graphite satin	+\$0
HF	inner tone laminate	+\$0
HT	inner tone	+\$0
LU	soft white	+\$0
MT	medium tone	+\$0
SG	slate grey	+\$0
WL	sandstone	+\$0
WN	warm grey neutral	+\$0

Step 10. Grommets

NTG	no grommet	+\$0
C	grommet center	+\$27

Step 11. Grommet Finish

For grommet center (C)

8Q	folkstone grey	+\$0
91	white	+\$0
BU	black umber	+\$0
CL	cool grey neutral	+\$0
HF	inner tone laminate	+\$0
LU	soft white	+\$0
MT	medium tone	+\$0
SG	slate grey	+\$0
WL	sandstone	+\$0
WN	warm grey neutral	+\$0

Curved Corner Desk, L Style

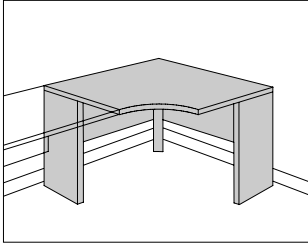

Product Information

Description

This 90° curved corner desk connects to a 5000 Series L-style component or stands alone. It has a laminate top and vinyl edge or a veneer top and edge and is available with a center grommet or no grommet. The desk has full or 10"-deep recessed end panels and 1" adjustable glides. Desks with recessed end panels have a cable management cutout at the back of the panel. The desk is available with a raised or open back panel. The raised back panel is 8¹/₈" from the floor and provides access to electrical components in panel system raceways; the open back panel is used against architectural walls and provides maximum access to electrical/data outlets, including those complying with ADA standards. The open back panel includes a horizontal support rail; the bottom of the support rail is 8¹/₈" from the floor.

Notes

To use curved corner desk at end of furniture run, specify full end panel.

Order optional desk components separately:

- L-style bridge
- L-style return with single pedestal

To manage cables under desk, order cable management trough separately.

Order optional display or storage components separately:

- Corner desk-mounted tackboard
- Flipper door unit

For accessory product applications, the following Compatibility Charts are available electronically for viewing and printing in Kiosk and HermanMiller.com: Keyboard Compatibility Charts, Pencil Drawer Compatibility Charts, and Work Organizer Compatibility Chart.

Dimensions

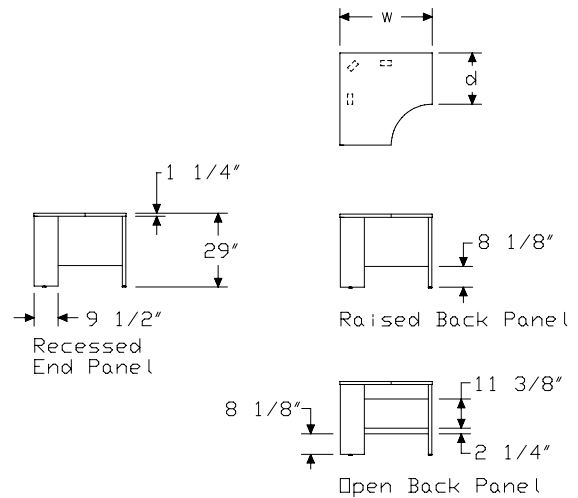

Curved Corner Desk, L Style

continued

5000 Series L-Style Products

Specification Information		
Step 1.		
5L		
Step 2. Back Panel		
P0-	open back panel	\$0
R0-	raised back panel	\$0
Step 3. Width/Depth		
424224-C	42" wide x 24" deep	+\$887
Step 4. End Panels (from User Side)		
SS	recessed end panel left, recessed end panel right	+\$0
Step 5. Paint/Steel Type		
SS	smooth paint on smooth steel	+\$0
Step 6. Understructure Finish		
8Q	folkstone grey	+\$0
BU	black umber	+\$0
HF	inner tone laminate	+\$0
LT	light tone	+\$0
LU	soft white	+\$0
MT	medium tone	+\$0
SG	slate grey	+\$0
WL	sandstone	+\$0
CN	metallic champagne	+\$60
EH	metallic bronze	+\$60
MS	metallic silver	+\$60
Step 7. Top		
TL	laminate top with vinyl edge	+\$0
TR	recut veneer top <input type="checkbox"/> A	+\$329
TF	wood veneer top <input type="checkbox"/> A	+\$388

Step 8.		
Top Finish: Solid-Color Laminate		
<i>For laminate top with vinyl edge (TL)</i>		
8Q	folkstone grey	+\$0
91	white	+\$0
CL	cool grey neutral	+\$0
HF	inner tone laminate	+\$0
HT	inner tone	+\$0
LT	light tone	+\$0
LU	soft white	+\$0
WL	sandstone	+\$0
WN	warm grey neutral	+\$0
Top Finish: Fiber Laminate		
<i>For laminate top with vinyl edge (TL)</i>		
1X	vanilla	+\$0
2X	wheat	+\$0
3X	celery	+\$0
4X	coriander	+\$0
5X	chamomile	+\$0
6X	cinnamon	+\$0
7X	cardamom	+\$0
8X	kale	+\$0
Top Finish: Frosted Laminate		
<i>For laminate top with vinyl edge (TL)</i>		
J4	frosted light grey	+\$0
J5	frosted inner tone light	+\$0
J6	frosted slate grey	+\$0
J7	frosted medium tone	+\$0
J8	frosted black	+\$0
Top/Edge Finish: Recut Veneer		
<i>For recut veneer top (TR)</i>		
RA	light ash <input type="checkbox"/> A	+\$0
RK	mahogany dark <input type="checkbox"/> A	+\$0
RM	mahogany <input type="checkbox"/> A	+\$0

Curved Corner Desk, L Style

continued

Top/Edge Finish: Wood Veneer

For wood veneer top (TF)

V3	cherry <input type="checkbox"/>	+\$0
Z3	warm red cherry <input type="checkbox"/>	+\$0
Z5	maple <input type="checkbox"/>	+\$0
ED	aged cherry <input type="checkbox"/>	+\$30
UL	natural maple <input type="checkbox"/>	+\$30
UQ	light cherry <input type="checkbox"/>	+\$30
UV	red cherry <input type="checkbox"/>	+\$30
UX	walnut on cherry <input type="checkbox"/>	+\$30

Step 9. Edge Finish

For laminate top with vinyl edge (TL)

8Q	folkstone grey	+\$0
91	white	+\$0
BU	black umber	+\$0
CL	cool grey neutral	+\$0
CM	cinnamon	+\$0
CO	chamomile	+\$0
G2	graphite satin	+\$0
HF	inner tone laminate	+\$0
HT	inner tone	+\$0
LU	soft white	+\$0
MT	medium tone	+\$0
SG	slate grey	+\$0
WL	sandstone	+\$0
WN	warm grey neutral	+\$0

Step 10. Grommets

NTG	no grommet	+\$0
C	grommet center	+\$27

Step 11. Grommet Finish

For grommet center (C)

8Q	folkstone grey	+\$0
91	white	+\$0
BU	black umber	+\$0
CL	cool grey neutral	+\$0
HF	inner tone laminate	+\$0
LU	soft white	+\$0
MT	medium tone	+\$0
SG	slate grey	+\$0
WL	sandstone	+\$0
WN	warm grey neutral	+\$0

D-Shaped Peninsula

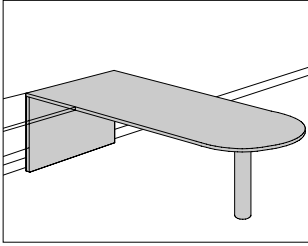

Product Information

Description

This D-shaped peninsula attaches to the side or end of a 5000 Series desk component. It has a laminate top and vinyl edge or a veneer top and edge and a column base. The side-attaching peninsula includes a full end panel and is available with or without grommets. Attachment hardware is included.

Notes

Order optional desk components separately:

- Desk shell
- Desk with single pedestal
- Return shell
- Return with single pedestal

To manage cables under peninsula, order cable management trough separately.

Order optional flipper door unit separately.

For accessory product applications, the following Compatibility Charts are available electronically for viewing and printing in Kiosk and HermanMiller.com: Keyboard Compatibility Charts, Pencil Drawer Compatibility Charts, and Work Organizer Compatibility Chart.

5000 Series L-Style Products

Dimensions

End Attaching

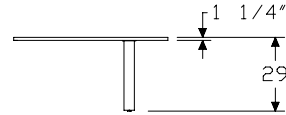
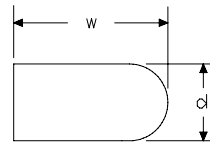

Side Attaching

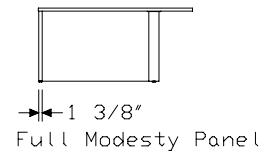
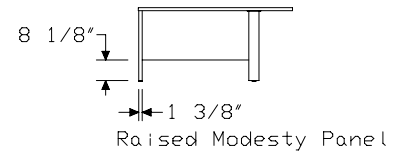
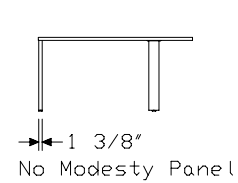
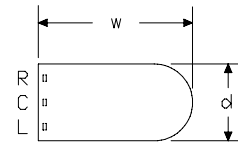

D-Shaped Peninsula *continued*

Specification Information

Step 1.

5-

Step 2. Width

48	48" wide	\$0
60	60" wide	\$0
66	66" wide	\$0
72	72" wide	\$0

Step 3. Depth

For 48" wide (48)

30-	30" deep	+\$845
------------	----------	--------

For 60" wide (60)

30-	30" deep	+\$880
36-	36" deep	+\$908

For 66" wide (66)

30-	30" deep	+\$934
36-	36" deep	+\$973

For 72" wide (72)

30-	30" deep	+\$939
36-	36" deep	+\$975

Step 4. Attachment

ED	end attaching	+\$0
SD	side attaching	+\$172

Step 5. Modesty Panel

For side attaching (SD)

NP	no modesty panel	+\$0
SP	raised modesty panel	+\$164
MP	full modesty panel	+\$187

Step 6. Steel Type

For end attaching (ED)

SS	smooth paint on smooth steel	+\$0
-----------	------------------------------	------

For side attaching (SD)

SS	smooth paint on smooth steel	+\$0
TS	smooth paint on textured steel	+\$0

Step 7. Understructure Finish

See Finish Colors list for paint codes.

	ED	SD
Nonmetallic Paint	+\$0	0
Metallic Paint	+\$15	40

Step 8. Top

	48	60	66	72	
NT	disposable top	-\$37	-37	-37	-37
TL	laminate top with vinyl edge	+\$0	0	0	0
TR	recut veneer top A	+\$301	336	368	402
TF	wood veneer top A	+\$332	368	407	440

Step 9.

Top Finish: Solid-Color Laminate

For laminate top with vinyl edge (TL)

8Q	folkstone grey	+\$0
91	white	+\$0
CL	cool grey neutral	+\$0
HF	inner tone light	+\$0
HT	inner tone	+\$0
LT	light tone	+\$0
LU	soft white	+\$0
WL	sandstone	+\$0
WN	warm grey neutral	+\$0

Top Finish: Fiber Laminate

For laminate top with vinyl edge (TL)

1X	vanilla	+\$0
2X	wheat	+\$0
3X	celery	+\$0
4X	coriander	+\$0
5X	chamomile	+\$0
6X	cinnamon	+\$0
7X	cardamom	+\$0
8X	kale	+\$0

Top Finish: Frosted Laminate

For laminate top with vinyl edge (TL)

J4	frosted light grey	+\$0
J5	frosted inner tone light	+\$0
J6	frosted slate grey	+\$0
J7	frosted medium tone	+\$0
J8	frosted black	+\$0

5000 Series L-Style Products

D-Shaped Peninsula *continued*

Top Finish: Wood-Grain Laminate		
<i>For laminate top with vinyl edge (TL)</i>		
LA	light ash	+\$0
LM	mahogany	+\$0

Top/Edge Finish: Recut Veneer		
<i>For recut veneer top (TR)</i>		
RA	light ash A	+\$0
RK	mahogany dark A	+\$0
RM	mahogany A	+\$0

Top/Edge Finish: Wood Veneer		
<i>For wood veneer top (TF)</i>		
V3	cherry A	+\$0
Z3	warm red cherry A	+\$0
Z5	maple A	+\$0
ED	aged cherry A	+\$30
EG	medium brown walnut A	+\$30
EK	medium red walnut A	+\$30
EY	light anigre A	+\$30
UL	natural maple A	+\$30
UQ	light cherry A	+\$30
UV	red cherry A	+\$30
UX	walnut on cherry A	+\$30

Step 10. Edge Finish		
<i>For laminate top with vinyl edge (TL)</i>		
8Q	folkstone grey	+\$0
91	white	+\$0
BU	black umber	+\$0
CL	cool grey neutral	+\$0
CM	cinnamon	+\$0
CO	chamomile	+\$0
G2	graphite satin	+\$0
HF	inner tone light	+\$0
HT	inner tone	+\$0
LA	light ash	+\$0
LM	mahogany	+\$0
LU	soft white	+\$0
MT	medium tone	+\$0
SG	slate grey	+\$0
WL	sandstone	+\$0
WN	warm grey neutral	+\$0

Step 11. Grommets		
<i>For side attaching (SD) with no modesty panel (NP)</i>		
NTG	no grommet	+\$0
L	grommet left	+\$27
C	grommet center	+\$27
R	grommet right	+\$27
2LC	grommets left and center	+\$53
2CR	grommets center and right	+\$53
2LR	grommets left and right	+\$53
3LCR	grommets left, center, and right	+\$79

<i>For side attaching (SD) with raised modesty panel (SP) or full modesty panel (MP)</i>		
NTG	no grommet	+\$0
L	grommet left	+\$27
R	grommet right	+\$27
2LR	grommets left and right	+\$53

Step 12. Grommet Finish		
<i>For grommet left (L), grommet center (C), grommet right (R), grommets left and center (2LC), grommets center and right (2CR), grommets left and right (2LR), or grommets left, center, and right (3LCR)</i>		
8Q	folkstone grey	+\$0
91	white	+\$0
BU	black umber	+\$0
CL	cool grey neutral	+\$0
HF	inner tone light	+\$0
LU	soft white	+\$0
MT	medium tone	+\$0
SG	slate grey	+\$0
WL	sandstone	+\$0
WN	warm grey neutral	+\$0

P-Shaped Peninsula

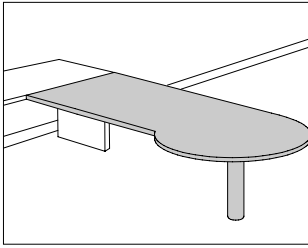

Product Information

Description

This P-shaped peninsula attaches to the side or end of a 5000 Series desk component. It has a laminate top and vinyl edge or a veneer top and edge and a column base. The side-attaching peninsula includes a full end panel and is available with or without grommets. Attachment hardware is included.

Notes

Order optional desk components separately:

- Desk shell
- Desk with single pedestal
- Return shell
- Return with single pedestal

To manage cables under peninsula, order cable management trough separately.

Order optional flipper door unit separately.

For accessory product applications, the following Compatibility Charts are available electronically for viewing and printing in Kiosk and HermanMiller.com: Keyboard Compatibility Charts, Pencil Drawer Compatibility Charts, and Work Organizer Compatibility Chart.

Dimensions

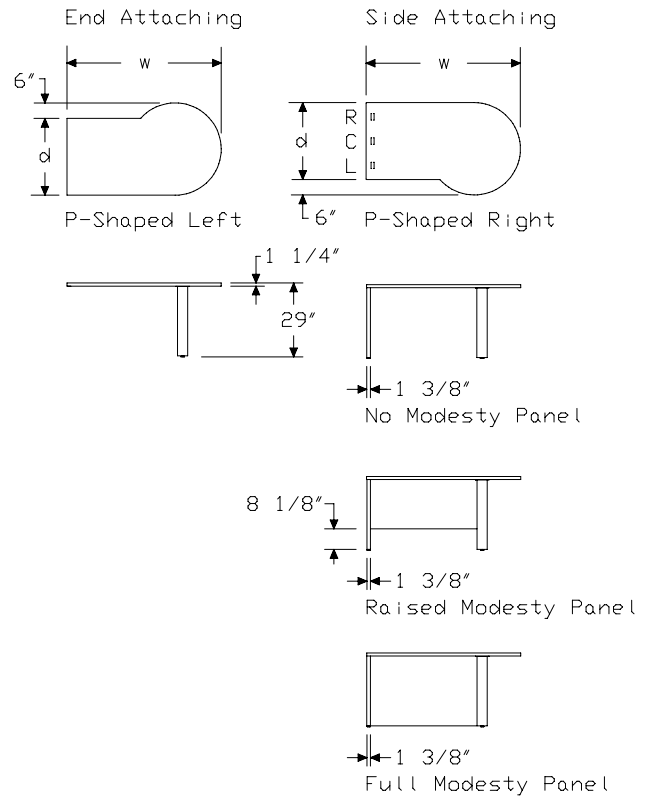

P-Shaped Peninsula *continued*

Specification Information		
Step 1.		
5-		
Step 2. Width		
48	48" wide	\$0
60	60" wide	\$0
66	66" wide	\$0
72	72" wide	\$0
Step 3. Depth		
<i>For 48" wide (48)</i>		
30-	30" deep	+\$1028
<i>For 60" wide (60)</i>		
30-	30" deep	+\$1067
36-	36" deep	+\$1123
<i>For 66" wide (66)</i>		
30-	30" deep	+\$1128
36-	36" deep	+\$1196
<i>For 72" wide (72)</i>		
30-	30" deep	+\$1134
36-	36" deep	+\$1204
Step 4. Attachment		
EP	end attaching	+\$0
SP	side attaching	+\$172
Step 5. Direction		
L	P-shaped left	+\$0
R	P-shaped right	+\$0
Step 6. Modesty Panel		
<i>For side attaching (SP)</i>		
NP	no modesty panel	+\$0
SP	raised modesty panel	+\$164
MP	full modesty panel	+\$187
Step 7. Steel Type		
<i>For end attaching (EP)</i>		
SS	smooth paint on smooth steel	+\$0

<i>For side attaching (SP)</i>		
SS	smooth paint on smooth steel	+\$0
TS	smooth paint on textured steel	+\$0

Step 8. Understructure Finish		
<i>See Finish Colors list for paint codes.</i>		
	EP	SP
Nonmetallic Paint	+\$0	0
Metallic Paint	+\$15	40

Step 9. Top					
		48	60	66	72
NT	disposable top	-\$37	-37	-37	-37
TL	laminate top with vinyl edge	+\$0	0	0	0
TR	recut veneer top A	+\$361	395	433	469
TF	wood veneer top A	+\$395	436	476	515

Step 10.		
Top Finish: Solid-Color Laminate		
<i>For laminate top with vinyl edge (TL)</i>		
8Q	folkstone grey	+\$0
91	white	+\$0
CL	cool grey neutral	+\$0
HF	inner tone light	+\$0
HT	inner tone	+\$0
LT	light tone	+\$0
LU	soft white	+\$0
WL	sandstone	+\$0
WN	warm grey neutral	+\$0

Top Finish: Fiber Laminate		
<i>For laminate top with vinyl edge (TL)</i>		
1X	vanilla	+\$0
2X	wheat	+\$0
3X	celery	+\$0
4X	coriander	+\$0
5X	chamomile	+\$0
6X	cinnamon	+\$0
7X	cardamom	+\$0
8X	kale	+\$0

Top Finish: Frosted Laminate		
<i>For laminate top with vinyl edge (TL)</i>		
J4	frosted light grey	+\$0
J5	frosted inner tone light	+\$0
J6	frosted slate grey	+\$0
J7	frosted medium tone	+\$0
J8	frosted black	+\$0

Top Finish: Wood-Grain Laminate		
<i>For laminate top with vinyl edge (TL)</i>		
LA	light ash	+\$0
LM	mahogany	+\$0

Top/Edge Finish: Recut Veneer		
<i>For recut veneer top (TR)</i>		
RA	light ash A	+\$0
RK	mahogany dark A	+\$0
RM	mahogany A	+\$0

Top/Edge Finish: Wood Veneer		
<i>For wood veneer top (TF)</i>		
V3	cherry A	+\$0
Z3	warm red cherry A	+\$0
Z5	maple A	+\$0
ED	aged cherry A	+\$30
EG	medium brown walnut A	+\$30
EK	medium red walnut A	+\$30
EY	light anigre A	+\$30
UL	natural maple A	+\$30
UQ	light cherry A	+\$30
UV	red cherry A	+\$30
UX	walnut on cherry A	+\$30

Step 11. Edge Finish		
<i>For laminate top with vinyl edge (TL)</i>		
8Q	folkstone grey	+\$0
91	white	+\$0
BU	black umber	+\$0
CL	cool grey neutral	+\$0
CM	cinnamon	+\$0
CO	chamomile	+\$0
G2	graphite satin	+\$0
HF	inner tone light	+\$0
HT	inner tone	+\$0
LA	light ash	+\$0
LM	mahogany	+\$0
LU	soft white	+\$0
MT	medium tone	+\$0
SG	slate grey	+\$0
WL	sandstone	+\$0
WN	warm grey neutral	+\$0

Step 12. Grommets		
<i>For side attaching (SP) with no modesty panel (NP)</i>		
NTG	no grommet	+\$0
L	grommet left	+\$27
C	grommet center	+\$27
R	grommet right	+\$27
2LC	grommets left and center	+\$53
2CR	grommets center and right	+\$53
2LR	grommets left and right	+\$53
3LCR	grommets left, center, and right	+\$79

<i>For side attaching (SP) with raised modesty panel (SP) or full modesty panel (MP)</i>		
NTG	no grommet	+\$0
L	grommet left	+\$27
R	grommet right	+\$27
2LR	grommets left and right	+\$53

P-Shaped Peninsula *continued*

Step 13. Grommet Finish

For grommet left (L), grommet center (C), grommet right (R), grommets left and center (2LC), grommets center and right (2CR), grommets left and right (2LR), or grommets left, center, and right (3LCR)

8Q	folkstone grey	+\$0
91	white	+\$0
BU	black umber	+\$0
CL	cool grey neutral	+\$0
HF	inner tone light	+\$0
LU	soft white	+\$0
MT	medium tone	+\$0
SG	slate grey	+\$0
WL	sandstone	+\$0
WN	warm grey neutral	+\$0

Return with Single Pedestal, L Style

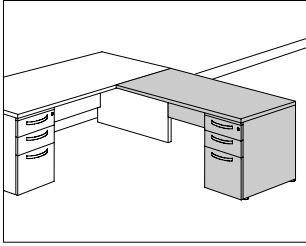

Product Information

Description

This return connects to a 5000 Series L-style desk component for additional workspace. It has 1 lockable support pedestal with 1" adjustable glides, Q pulls, and a choice of front styles. Box drawers have 1 drawer divider and full-extension steel ball-bearing slides. File drawers hold letter-size front-to-back hanging files and include 2 file converters for legal-size filing. File drawers have full-extension steel ball-bearing slides. Attachment hardware is included.

The return has a laminate top and vinyl edge or a veneer top and edge and is available with a center grommet or no grommet. The return has a raised or open back panel. The raised back panel is 8 1/8" from the floor and provides access to electrical components in panel system raceways; the open back panel is used against architectural walls or panel systems and provides maximum access to electrical/data outlets, including those complying with ADA standards. The open back panel includes a horizontal support rail; the bottom of the support rail is 8 1/8" from the floor.

Notes

Order optional desk components separately:

- L-style corner desk
- L-style curved corner desk
- L-style desk with single pedestal

To manage cables under return, order cable management trough separately.

Order optional display or storage components separately:

- Desk-mounted tackboard
- Desk-mounted tool rail with tackboard
- End-mounted tackboard
- Flipper door unit

For accessory product applications, the following Compatibility Charts are available electronically for viewing and printing in Kiosk and HermanMiller.com: Keyboard Compatibility Charts, Pencil Drawer Compatibility Charts, and Work Organizer Compatibility Chart.

Pedestal ships with lock plugs keyed differently (KD). For keyed-alike locks on multiple pedestals, specify keyed alike (KA); separate lock plugs are shipped and field installed on each pedestal. See Keyed-Alike Information in Appendices.

Dimensions

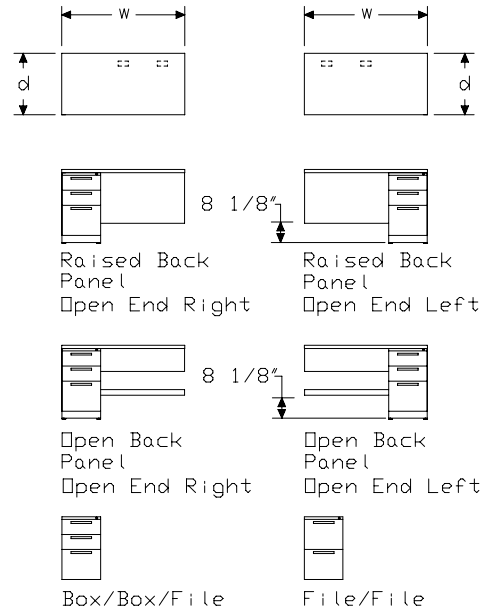

Return with Single Pedestal, L Style *continued*

Specification Information		
Step 1.		
5L		
Step 2. Back Panel		
P	open back panel	\$0
R	raised back panel	\$0
Step 3. Pedestal Pull/Front Style		
Q-	Q-pull	+\$100
Step 4. Width/Depth		
3624-	36" wide x 24" deep	+\$465
4224-	42" wide x 24" deep	+\$497
4824-	48" wide x 24" deep	+\$525
6024-	60" wide x 24" deep	+\$590
Step 5. Configuration (from User Side)		
GOD	file/file left, open end right	+\$165
OGD	open end left, file/file right	+\$165
HOD	box/box/file left, open end right	+\$175
OHD	open end left, box/box/file right	+\$175
Step 6. Paint/Steel Type		
SS	smooth paint on smooth steel	+\$0
Step 7. Understructure Finish		
8Q	folkstone grey	+\$0
BU	black umber	+\$0
HF	inner tone light	+\$0
LT	light tone	+\$0
LU	soft white	+\$0
MT	medium tone	+\$0
SG	slate grey	+\$0
WL	sandstone	+\$0
CN	metallic champagne	+\$80
EH	metallic bronze	+\$80
MS	metallic silver	+\$80
Step 8. Pull Finish		
BW	warm bronze	+\$0
NH	brushed nickel	+\$0
NK	black nickel	+\$0

Step 9. Top					
		3624-	4224-	4824-	6024-
TL	laminate top with vinyl edge	+\$0	0	0	0
TR	recut veneer top <input type="checkbox"/> A	+\$313	340	367	399
TF	wood veneer top <input type="checkbox"/> A	+\$368	402	433	471

Step 10.		
Top Finish: Solid-Color Laminate		
<i>For laminate top with vinyl edge (TL)</i>		
8Q	folkstone grey	+\$0
91	white	+\$0
CL	cool grey neutral	+\$0
HF	inner tone light	+\$0
HT	inner tone	+\$0
LT	light tone	+\$0
LU	soft white	+\$0
WL	sandstone	+\$0
WN	warm grey neutral	+\$0

Top Finish: Fiber Laminate		
<i>For laminate top with vinyl edge (TL)</i>		
1X	vanilla	+\$0
2X	wheat	+\$0
3X	celery	+\$0
4X	coriander	+\$0
5X	chamomile	+\$0
6X	cinnamon	+\$0
7X	cardamom	+\$0
8X	kale	+\$0

Top Finish: Frosted Laminate		
<i>For laminate top with vinyl edge (TL)</i>		
J4	frosted light grey	+\$0
J5	frosted inner tone light	+\$0
J6	frosted slate grey	+\$0
J7	frosted medium tone	+\$0
J8	frosted black	+\$0

Top/Edge Finish: Recut Veneer		
<i>For recut veneer top (TR)</i>		
RA	light ash <input type="checkbox"/> A	+\$0
RK	mahogany dark <input type="checkbox"/> A	+\$0
RM	mahogany <input type="checkbox"/> A	+\$0

Return with Single Pedestal, L

Style *continued*

Top/Edge Finish: Wood Veneer

For wood veneer top (TF)

V3	cherry <input type="checkbox"/>	+\$0
Z3	warm red cherry <input type="checkbox"/>	+\$0
Z5	maple <input type="checkbox"/>	+\$0
ED	aged cherry <input type="checkbox"/>	+\$20
UL	natural maple <input type="checkbox"/>	+\$20
UQ	light cherry <input type="checkbox"/>	+\$20
UV	red cherry <input type="checkbox"/>	+\$20
UX	walnut on cherry <input type="checkbox"/>	+\$20

Step 11. Edge Finish

For laminate top with vinyl edge (TL)

8Q	folkstone grey	+\$0
91	white	+\$0
BU	black umber	+\$0
CL	cool grey neutral	+\$0
CM	cinnamon	+\$0
CO	chamomile	+\$0
G2	graphite satin	+\$0
HF	inner tone light	+\$0
HT	inner tone	+\$0
LU	soft white	+\$0
MT	medium tone	+\$0
SG	slate grey	+\$0
WL	sandstone	+\$0
WN	warm grey neutral	+\$0

Step 12. Grommets

NTG	no grommet	+\$0
C	grommet center	+\$27

Step 13. Grommet Finish

For grommet center (C)

8Q	folkstone grey	+\$0
91	white	+\$0
BU	black umber	+\$0
CL	cool grey neutral	+\$0
HF	inner tone light	+\$0
LU	soft white	+\$0
MT	medium tone	+\$0
SG	slate grey	+\$0
WL	sandstone	+\$0
WN	warm grey neutral	+\$0

Step 14. Lock

KA	keyed alike	+\$0
KC	keyed differently, chrome	+\$0
KD	keyed differently, black	+\$0

Bridge, L Style

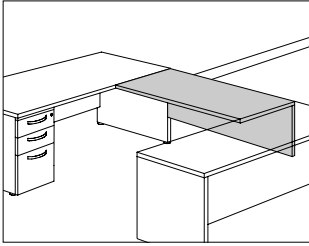

Product Information

Description

This bridge connects two 5000 Series L-style components to provide a continuous work surface. It has a laminate top and vinyl edge or a veneer top and edge and is available with a center grommet or no grommet. The bridge has a raised or open back panel. The raised back panel is $8\frac{1}{8}$ " from the floor and provides access to electrical components in panel system raceways; the open back panel is used against architectural walls or panel systems and provides maximum access to electrical/data outlets, including those complying with ADA standards. The open back panel includes a horizontal support rail; the bottom of the support rail is $8\frac{1}{8}$ " from the floor. Attachment hardware is included.

Notes

Order optional desk components separately:

- L-style corner desk
- L-style curved corner desk
- L-style desk with single pedestal

To manage cables under bridge, order cable management trough separately.

Order optional display or storage components separately:

- Desk-mounted tackboard
- Desk-mounted tool rail with tackboard
- End-mounted tackboard
- Flipper door unit

For accessory product applications, the following Compatibility Charts are available electronically for viewing and printing in Kiosk and HermanMiller.com: Keyboard Compatibility Charts, Pencil Drawer Compatibility Charts, and Work Organizer Compatibility Chart.

Dimensions

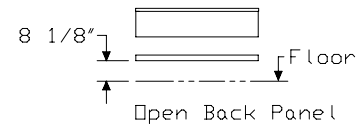
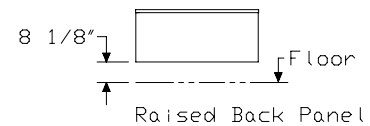
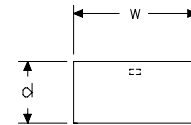
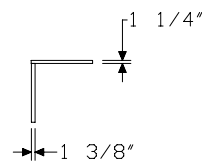

Specification Information

Step 1.

5L

Step 2. Back Panel

P0-	open back panel	\$0
R0-	raised back panel	\$0

Step 3. Width/Depth

2424-D	24" wide x 24" deep	+\$319
3024-D	30" wide x 24" deep	+\$336
3624-D	36" wide x 24" deep	+\$352
4224-D	42" wide x 24" deep	+\$380
4824-D	48" wide x 24" deep	+\$419

Step 4. Paint/Steel Type

SS	smooth paint on smooth steel	+\$0
-----------	------------------------------	------

Step 5. Understructure Finish

8Q	folkstone grey	+\$0
BU	black umber	+\$0
HF	inner tone laminate	+\$0
LT	light tone	+\$0
LU	soft white	+\$0
MT	medium tone	+\$0
SG	slate grey	+\$0
WL	sandstone	+\$0
CN	metallic champagne	+\$15
EH	metallic bronze	+\$15
MS	metallic silver	+\$15

Step 6. Top

		2424-D	3024-D	3624-D	4224-D	4824-D
TL	laminate top with vinyl edge	+\$0	0	0	0	0
TR	recut veneer top A	+\$297	297	313	340	367
TF	wood veneer top A	+\$349	349	368	402	433

Step 7.

Top Finish: Solid-Color Laminate

For laminate top with vinyl edge (TL)

8Q	folkstone grey	+\$0
91	white	+\$0
CL	cool grey neutral	+\$0
HF	inner tone laminate	+\$0
HT	inner tone	+\$0
LT	light tone	+\$0
LU	soft white	+\$0
WL	sandstone	+\$0
WN	warm grey neutral	+\$0

Top Finish: Fiber Laminate

For laminate top with vinyl edge (TL)

1X	vanilla	+\$0
2X	wheat	+\$0
3X	celery	+\$0
4X	coriander	+\$0
5X	chamomile	+\$0
6X	cinnamon	+\$0
7X	cardamom	+\$0
8X	kale	+\$0

Top Finish: Frosted Laminate

For laminate top with vinyl edge (TL)

J4	frosted light grey	+\$0
J5	frosted inner tone light	+\$0
J6	frosted slate grey	+\$0
J7	frosted medium tone	+\$0
J8	frosted black	+\$0

Top/Edge Finish: Recut Veneer

For recut veneer top (TR)

RA	light ash A	+\$0
RK	mahogany dark A	+\$0
RM	mahogany A	+\$0

Bridge, L Style *continued*

5000 Series L-Style Products

Top/Edge Finish: Wood Veneer

For wood veneer top (TF)

V3	cherry <input type="checkbox"/> A	+\$0
Z3	warm red cherry <input type="checkbox"/> A	+\$0
Z5	maple <input type="checkbox"/> A	+\$0
ED	aged cherry <input type="checkbox"/> A	+\$20
UL	natural maple <input type="checkbox"/> A	+\$20
UQ	light cherry <input type="checkbox"/> A	+\$20
UV	red cherry <input type="checkbox"/> A	+\$20
UX	walnut on cherry <input type="checkbox"/> A	+\$20

Step 8. Edge Finish

For laminate top with vinyl edge (TL)

8Q	folkstone grey	+\$0
91	white	+\$0
BU	black umber	+\$0
CL	cool grey neutral	+\$0
CM	cinnamon	+\$0
CO	chamomile	+\$0
G2	graphite satin	+\$0
HF	inner tone laminate	+\$0
HT	inner tone	+\$0
LU	soft white	+\$0
MT	medium tone	+\$0
SG	slate grey	+\$0
WL	sandstone	+\$0
WN	warm grey neutral	+\$0

Step 9. Grommets

NTG	no grommet	+\$0
C	grommet center	+\$27

Step 10. Grommet Finish

For grommet center (C)

8Q	folkstone grey	+\$0
91	white	+\$0
BU	black umber	+\$0
CL	cool grey neutral	+\$0
HF	inner tone laminate	+\$0
LU	soft white	+\$0
MT	medium tone	+\$0
SG	slate grey	+\$0
WL	sandstone	+\$0
WN	warm grey neutral	+\$0

Cable Management Trough

WM-67

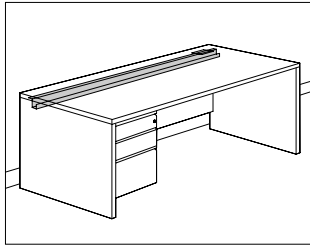

Product Information

Description

This 67"-long vinyl trough attaches under a 5000 Series work surface to manage cables. It holds 24 category 5 cables and has pre-punched mounting holes. The trough can be field cut to the appropriate length. Finish is black umber.

Dimensions

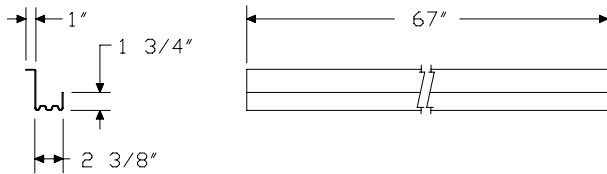

Specification Information

Step 1.

WM-67

\$45

Electrical Distributor, Multi-Outlet

NP289

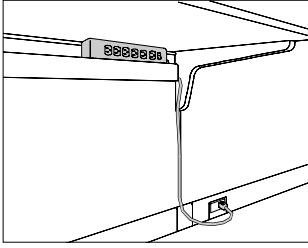

Product Information

Description

This electrical distributor attaches to an Action Office® or Prospects® panel-suspended cable management trough or to a 5000 Series cable management trough. It also fits into an Abak® beam-attached cable channel. The electrical distributor provides additional receptacles at work surface height and has 6 standard, 3-prong receptacles with a 15-amp circuit breaker. It is UL listed and CSA certified. Finish is black umber.

Notes

For use with Action Office or Prospects products, order panel-suspended cable management trough (AO381.) separately.

For use with 5000 Series desk, order cable management trough (WM-67) separately.

For use with Abak products, order beam-attached cable channel (AK242.) separately.

Dimensions

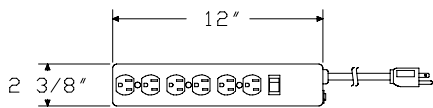

Specification Information

Step 1.

NP289

\$81

Flipper Door Unit

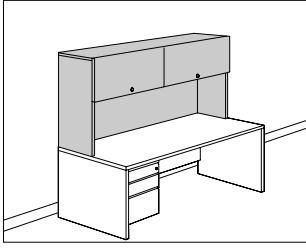

Product Information

Description

This lockable storage unit hangs from 2 straight-end panels at each end of a 5000 Series desk component. It includes a flipper door to enclose binders, files, and other items. The underside of the unit accepts a task light. The flipper door unit has a painted, fabric-covered, or veneer front. It is available with an open or closed back. The closed back unit has a tackboard or a tool rail with an 8¹/₂"-high tackboard on top. Attachment hardware is included.

Notes

When flipper door is open, it sits on top of storage unit.

Flipper door units wider than 48" have 2 doors.

Tool rail has same paint color as flipper door unit. For different color options, contact Customer Care.

Order optional task light separately:

- Performance task light (G6114.)
- Utility task light (G6136.)

For accessory product applications, the following Compatibility Charts are available electronically for viewing and printing in Kiosk and HermanMiller.com: Keyboard Compatibility Charts, Pencil Drawer Compatibility Charts, and Work Organizer Compatibility Chart.

Fabric-covered flipper door, tackboard, and tool rail/tackboard accept Customer's Own Material (COM). Yardage is estimated for directional, 54"-wide fabrics.

Flipper Door:

Width—Yardage

30" — 1¹/₈

36" — 1¹/₄

42" — 1³/₈

48" — 1³/₅

60" — 1¹/₂

66" — 1¹/₂

72" — 1¹/₂

Tackboard (T):

Width—Yardage

30" — 1¹/₈

36" — 1¹/₄

42" — 1¹/₂

48" — 1³/₅

60" — 2¹/₄

66" — 2¹/₂

72" — 2¹/₂

Tool Rail/Tackboard (R):

Width—Yardage

30" — 1¹/₈

36" — 1¹/₄

42" — 1¹/₂

48" — 1³/₅

60" — 2¹/₄

66" — 2¹/₂

72" — 2¹/₂

For information on multiple quantities or directional fabrics, contact COM Department. See Order Information in Appendices.

For keyed-alike flipper door units, specify keyed alike (KA or KQ); separate lock plugs are shipped and field installed on each flipper door unit.

Flipper Door Unit *continued*

5000 Series L-Style Products

Dimensions

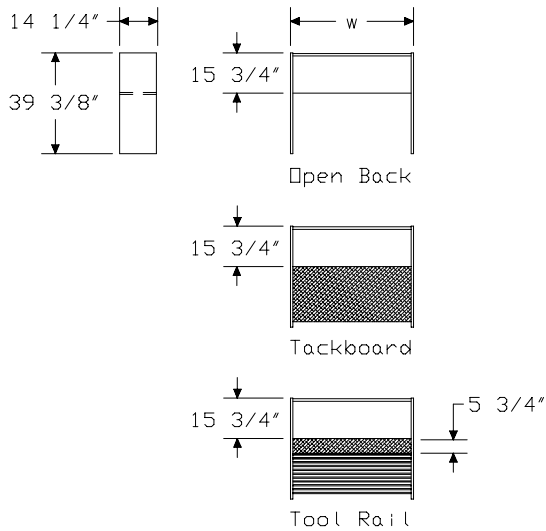

Specification Information

Step 1.		
5		
Step 2. Door Material		
-	painted door	\$0
F-	fabric door	\$173
WR-	recut veneer door <input type="checkbox"/> A	\$268
WF-	wood veneer door <input type="checkbox"/> A	\$293
Step 3. Width		
<i>For painted door (-) or fabric door (F-)</i>		
3039-OD	30" wide	+\$863
3639-OD	36" wide	+\$922
4239-OD	42" wide	+\$976
4839-OD	48" wide	+\$1026
6039-OD	60" wide	+\$1175
6639-OD	66" wide	+\$1228
7239-OD	72" wide	+\$1292
<i>For recut veneer door (WR-) or wood veneer door (WF-)</i>		
3039-OD	30" wide <input type="checkbox"/> A	+\$863
3639-OD	36" wide <input type="checkbox"/> A	+\$922
4239-OD	42" wide <input type="checkbox"/> A	+\$976
4839-OD	48" wide <input type="checkbox"/> A	+\$1026
6039-OD	60" wide <input type="checkbox"/> A	+\$1391
6639-OD	66" wide <input type="checkbox"/> A	+\$1441
7239-OD	72" wide <input type="checkbox"/> A	+\$1507
Step 4. Back		
O	open back	+\$0
T	tackboard	+\$223
R	tool rail	+\$371

Flipper Door Unit *continued*

Step 5. Door Finish

See application chart and textiles list for fabric usage and numbers. First 2 digits of number indicate fabric line; remaining digit(s) indicate fabric color.

For fabric door (F-)

Price Category 1	+\$0
Price Category 2	+\$10
Price Category 3	+\$15
Price Category 4	+\$25
Price Category B	+\$39
Price Category C	+\$59
Price Category D	+\$78
Price Category E	+\$98
Price Category F	+\$135

Recut Veneer

For recut veneer door (WR-)

RA light ash A	+\$0
RK mahogany dark A	+\$0
RM mahogany A	+\$0

Wood Veneer

For wood veneer door (WF-)

V3 cherry A	+\$0
Z3 warm red cherry A	+\$0
Z5 maple A	+\$0
ED aged cherry A	+\$25
EG medium brown walnut A	+\$25
EK medium red walnut A	+\$25
EY light anigre A	+\$25
UL natural maple A	+\$25
UQ light cherry A	+\$25
UV red cherry A	+\$25
UX walnut on cherry A	+\$25

Step 6. Steel Type

SS smooth paint on smooth steel	+\$0
TS smooth paint on textured steel	+\$0

Step 7. Case/End Panel/Door/Tool Rail Finish

See Finish Colors list for paint codes.

Nonmetallic Paint	+\$0
Metallic Paint	+\$30

Step 8. Tackboard Fabric

See application chart and textiles list for fabric usage and numbers. First 2 digits of number indicate fabric line; remaining digit(s) indicate fabric color.

	T	R
Price Category 1	+\$0	0
Price Category 2	+\$10	5
Price Category 3	+\$50	25
Price Category 4	+\$79	40
Price Category B	+\$59	32
Price Category C	+\$88	47
Price Category D	+\$117	63
Price Category E	+\$147	78
Price Category F	+\$203	108

Step 9. Lock

KD keyed differently with black lock	+\$0
KC keyed differently with chrome lock	+\$0
KA keyed alike with black lock	+\$0
KQ keyed alike with chrome lock	+\$0

Shelf Divider

6-5-D

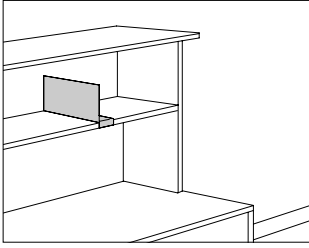

Product Information

Description
This divider attaches to a 5000 Series shelf to vertically divide books and binders. Finish is black umber.

Dimensions

Specification Information

Step 1.
6-5-D \$27

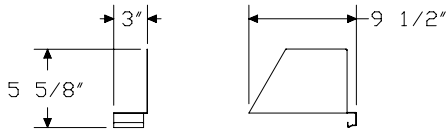

5000 Series L-Style Products

Pencil Drawer

72-20
72-21

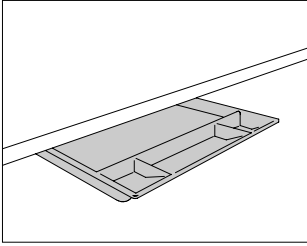

Product Information

Description

This plastic or metal pencil drawer mounts under a freestanding 5000 Series work surface to store pencils and other small items. Mounting hardware is included.

Notes

Plastic pencil drawer is available in black umber (BU) only.

Dimensions

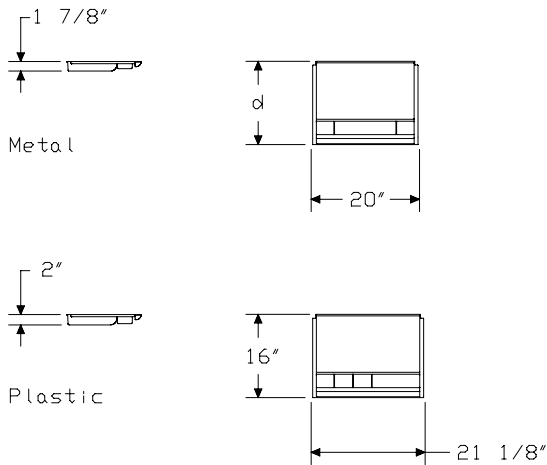

Specification Information

Step 1.

72-

Step 2. Material/Usage

2013-SP	metal for 20"-deep work surfaces	\$115
2016-SP	metal for 24", 30", or 36"-deep work surfaces	\$115
2116-2	plastic (available in black only)	\$91

Step 3. Finish

For metal for 20"-deep work surfaces (2013-SP) or metal for 24", 30", or 36"-deep work surfaces (2016-SP)

See Finish Colors list for paint codes.

Nonmetallic Paint	+\$0
Metallic Paint	+\$5

Index by Product Name

5000 Series Furniture	
	page(s)
Bridge	67
Bridge, L Style	128
Cable Management Trough	73, 131
Corner Bridge	70
Corner Desk	19
Corner Desk, L Style	112
Corner Return Shell	57
Corner Return with Single Pedestal	61
Credenza	75
Curved Corner Desk	22
Curved Corner Desk with D-Shaped Peninsula	25
Curved Corner Desk with P-Shaped Peninsula	28
Curved Corner Desk, L Style	115
D-Shaped Peninsula	40, 118
Desk-Mounted Tackboard	98
Desk-Mounted Tool Rail with Tackboard	99
Desk Shell	5
Desk with Double Pedestal	14
Desk with Double Pedestal, L Style	109
Desk with Single Pedestal	8
Desk with Single Pedestal, L Style	105
Drawer Divider for Box Drawer, Meridian® Pedestal	87
Drawer Divider, Tu™ Pedestal	92
Electrical Distributor, Multi-Outlet	74, 132
Extended Curved Corner Desk Shell	31
Extended Curved Corner Desk with Single Pedestal	34
File Compressor, Tu™ Pedestal	96
File Converter, Tu™ Pedestal	95
File Drawer Organizer	91, 97
File Drawer Organizer, Meridian® Pedestal	90
Flipper Door Unit	77, 133
P-Shaped Peninsula	43, 121
Pencil Drawer	81, 137
Pencil Tray for Box Drawer, Meridian® Pedestal	89
Performance Task Light	101
Return Shell	47
Return with Single Pedestal	51
Return with Single Pedestal, L Style	125
Shelf Divider	80, 136
Stationery Divider, Tu™ Pedestal	93
Stationery Tray for Box Drawer, Meridian® Pedestal	88
Suspended Pedestal with B- or F-Pull	85
Suspended Pedestal with Standard, Contour, or Bevel Pull	82
Twist™ LED Task Light	100
Utility Task Light	104

Utility Tray, Tu™ Pedestal	94
----------------------------	----

For more information about our products and services or to see a list of dealers, please visit us at www.HermanMiller.com or call (800) 851 1196.

This book is recyclable. Printed in U.S.A. on recycled paper.

© 2009 Herman Miller, Inc., Zeeland, Michigan

© HermanMiller, , Abak, Action Office, Aeron, Ambi, Ardea, Aside, Avive, Babble, C2, Caper, Celle, Co/Struc, DOT, Eames, Embody, Equa 2, Ergon 3, Ethospace, Fine-Tune, FlexFront, Formcoat, Ground Cloth, Herman Miller for Healthcare, Herman Miller Options, Intersect, Kinemat, Leaf, Lifework, Limerick, Meridian, Mirra, Passage, Pedastool, Pellicle, Perspectives, PostureFit, Prospects, Quadrant, Reaction, Resolve, RoomTune, Scooter, Stoa, Teneo, V-Wall, Vary Easy, Vivo, and Z-Axis are among the registered trademarks of Herman Miller, Inc., and its owned subsidiaries.

™ About Face, AireWeave, Airia, Arrio, Backfit, Boomerang, Bubbletack, Burdick Group, Celeste, Cellular Suspension, CLT, CoActive, Cognita, Compass, Cygnus, Enchord, EnhancedAccess, E-Wall, Flex-Edge, Flute, Harmonic, Herman Miller for the Home, Herman Miller International Collection, Herman Miller Select, Hopsak 2, Intent, Iota, Keyless Entry, Latitude, Lyris, Multiscrim, My Studio Environments, Nelson, Pixelated Support, Programmable Environments, Q, Rapunzel, Recline Selector, Sense, Setu, Stackable, Stackable Storage, The Be Collection, Thinking is good for you, TriFlex, Tu, and Twist are among the trademarks of Herman Miller, Inc., and its owned subsidiaries.

SM TAP, Textile Alliance Program and Thoughtpile are among the service marks of Herman Miller, Inc.

Chemsurf is a registered trademark of Wilsonart International.

Corian is a registered trademark of DuPont.

FLEXNET is a trademark of Milliken & Co.

Floor Saver Glide™ is a trademark of Carpin Manufacturing Inc.

Geiger is a registered trademark of Geiger International.

Goetz is a trademark of Mark W. Goetz.

Hang-It-All is a registered trademark of Lucia Eames Demetrios, d.b.a. Eames Office.

Holophane is a registered trademark of Holophane.

Ingeo is a trademark of Cargill Dow LLC.

Microsoft and Natural Keyboard are registered trademarks of Microsoft Corporation.

Noguchi® is a registered trademark of The Isamu Noguchi Foundation and Garden Museum.

Qt Quiet technology and Qt are trademarks of Cambridge Sound Management, Inc.