

## Classic Seating

Prices effective December 7, 2009  
Published March 2010

<b>Introduction</b>	<b>page 2</b>
<b>Eames® Aluminum Group Chairs</b>	<b>3</b>
Executive Chair	5
Management Chair	6
Side Chair	7
Lounge Chair and Ottoman	8
<b>Eames Soft Pad Group Chairs</b>	<b>11</b>
Executive Chair	13
Management Chair	14
Side Chair	15
Lounge Chair and Ottoman	16
<b>Eames Executive Work Chair</b>	<b>19</b>
<b>Eames Tandem Sling Seating</b>	<b>23</b>
<b>Eames Classic Seating</b>	<b>31</b>
Lounge Seating	33
Sofas	37
Molded Plywood Chairs	39
Molded Plastic Chairs	43
Wire Chair	48
<b>Nelson™ Swag Leg Group</b>	<b>49</b>
<b>Nelson Classic Seating</b>	<b>53</b>
Coconut Chair	55
Platform Bench	56
Marshmallow Sofa	57
<b>Goetz™ Sofa</b>	<b>59</b>
<b>Capelli Stool</b>	<b>63</b>
<b>Indices</b>	<b>67</b>
By Name	67
By Number	69
<b>Appendices</b>	
To view and/or print price book appendices, select the appropriate price book from <a href="http://HermanMiller.com">HermanMiller.com</a> .	

# Introduction

## A Note on the Organization of This Book

There are a few signals that will help you understand the organization of this book. Once you know them, you should be able to find your way around easily.

### Like a newspaper, this book is formatted with columns of text and illustrations that run vertically.

Information wraps from one column to the next and continues for as many pages as it needs to.

### Black bars are clues.

A black bar at the top of a page signals the start of information about a product.

This information is divided into two sections, each signaled by a black bar. Product Information includes a description, additional notes, and dimensional drawings. Specification Information, which always begins at the top of a column, includes a series of steps. Each step represents a decision you need to make in order to complete your product number. Steps must be followed sequentially. The number of pages needed to complete information on a product varies; some will be complete in one page; others may fill three or four pages. Just continue going through the steps until you run into the next product, signaled by the black bar at the top of the page.

Black tabs running along the outside edge of the page help you locate what section you are in or what section you want to go to. You can thumb forwards or backwards to find a section; tabs and text appear on both sides of the page.

The additional pages in the back of the book include the appendices and indices. They are signaled by a long black bar running along the outside edge of the page.

### The index is presented two ways.

The first index is in alphabetical order by product name. It can be helpful if you are new to the products and numbering scheme or if you are looking for a type of product, such as work chair or round table.

The second index is by product number. It lists, in alphanumeric order, the base product number, typically a five-digit number.

## General Information

This book is effective December 7, 2009, subject to change without notice. Products may be purchased from authorized Herman Miller dealers who will quote prices upon request. For more information about our products and services or to see a list of dealers, visit [www.HermanMiller.com](http://www.HermanMiller.com).

All prices are list prices. Additional services, such as planning services, design, storage, and installation, are not included and must be added to these prices when the additional services are requested.

Illustrations, specifications, and prices are based on the latest information at the time of publication. The right is reserved to make changes at any time without notice in prices, fabrics, finishes, materials, specifications, and models, and also to discontinue models and finishes.

Dimensions shown in the drawings are engineering drawing dimensions rounded up to the nearest  $\frac{1}{8}$ ". Product is shipped set up or knocked down. Products that include "Shipped knocked down" in the description require some assembly. If this statement does not appear in the description, the product is shipped assembled.

Service problems are normally handled by a Herman Miller authorized dealer. Where this cannot be accomplished on a local level, service problems should be referred to the Customer Care Representative for your region, Herman Miller, Inc., Zeeland, Michigan 49464.

### 20-Day or Less/Assigned Lead-Time Shipments

All products and options in this price book not designated by an Assigned Program icon  will ship in **20 business days or less** after being acknowledged by Herman Miller.

Products and options designated by an  are on the assigned lead-time program and may ship in 20 days, less than 20 days, or more than 20 days from order acknowledgement.

**Executive Chair**

**Management Chair**

**Side Chair**

**Lounge Chair and Ottoman**





# Executive Chair

EA337

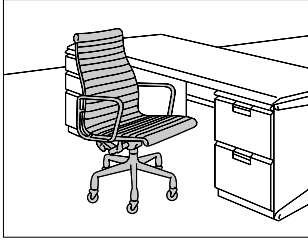

### Product Information

#### Description

This high-back chair with arms has a lightweight aluminum frame with suspended upholstery. It has a 5-star base with casters, tilt-swivel mechanism, and manual seat-height adjustment or pneumatic seat-height adjustment and tilt lock feature.

#### Notes

Chair is tested and warranted for use by persons 300 pounds and under. For description of casters, see Casters and Glides in Appendices. Customer's Own Material (COM) requires 1½ yards. Customer's Own Leather (COL) requires 45 square feet. See Order Information in Appendices.

#### Dimensions

Manual

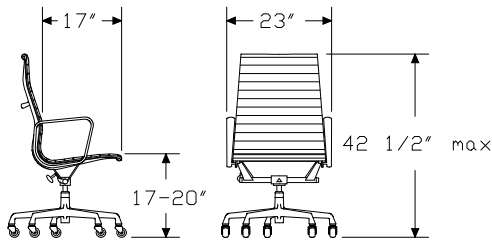

Pneumatic

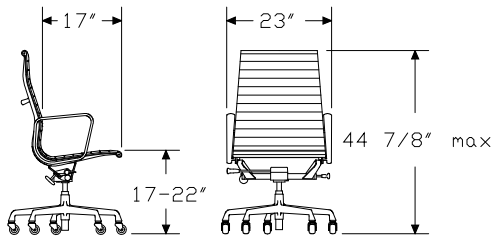

### Specification Information

#### Step 1.

**EA33**  A

#### Step 2. Seat-Height Adjustment

**7** manual seat-height adjustment  A

**7P** pneumatic seat-height adjustment  A

#### Prices for Steps 1-2.

<b>EA337</b>	\$1554
<b>EA337P</b>	\$1694

#### Step 3. Casters

**CA** 2" single wheel caster, hard floors or carpet  A +\$0

**UD** 2" hard double wheel caster, carpet, black painted  A +\$0

**VD** 2" hard double wheel caster, carpet, chrome  A +\$0

#### Step 4. Base/Frame Finish

**L** polished aluminum  A +\$0

#### Step 5. Fabric

See application chart and textiles list for fabric usage and numbers. First 2 digits of number indicate fabric line; remaining digit(s) indicate fabric color.

Price Category 1	+\$0
Price Category 2	+\$45
Price Category 3	+\$102
Price Category 4	+\$147
Price Category 7	+\$240
Price Category 9	+\$621
Price Category B	+\$46
Price Category E	+\$115
Price Category H	+\$276
Price Category R	+\$1105
Price Category V	+\$2028

# Management Chair

EA334  
EA335

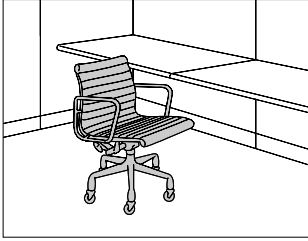

Eames® Aluminum Group Management Chair

## Product Information

**Description**  
This low-back chair with arms has a lightweight aluminum frame with suspended upholstery. It has a 5-star base, tilt-swivel mechanism, and manual seat-height adjustment or pneumatic seat-height adjustment and tilt lock feature. The chair is available with casters or glides. The chair with glides includes 1/2" (GD) glides for hard floors or carpet.

**Notes**  
Chair is tested and warranted for use by persons 300 pounds and under. For description of casters and glides, see Casters and Glides in Appendices.  
Customer's Own Material (COM) requires 1 1/3 yards. Customer's Own Leather (COL) requires 45 square feet. See Order Information in Appendices.

## Dimensions

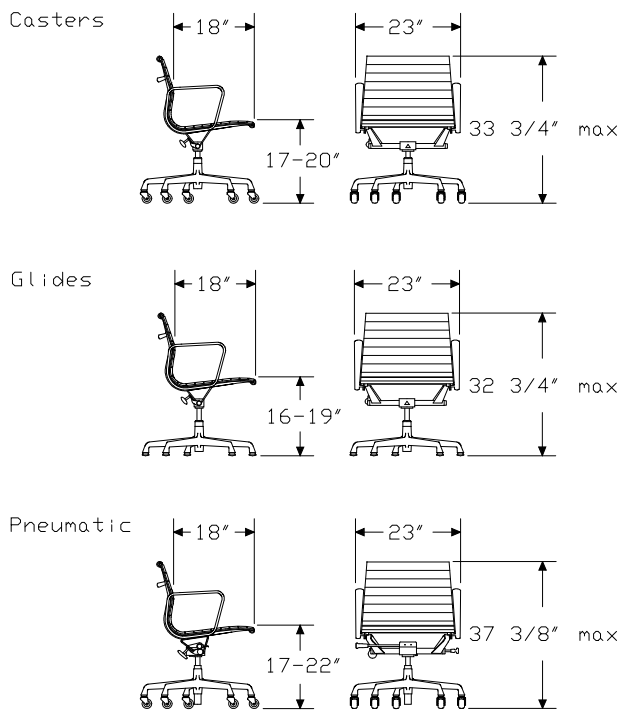

## Specification Information

Step 1.

- EA33**  A
- Step 2. Casters/Glides/Seat-Height Adjustment
- 5** casters with manual seat-height adjustment  A
  - 4** glides with manual seat-height adjustment  A
  - 5P** casters with pneumatic seat-height adjustment  A

Prices for Steps 1-2.

<b>EA335</b>	\$1422
<b>EA334</b>	\$1422
<b>EA335P</b>	\$1562

Step 3. Casters

- For casters with manual seat-height adjustment (5) or casters with pneumatic seat-height adjustment (5P)*
- CA** 2" single wheel caster, hard floors or carpet  A +\$0
  - UD** 2" hard double wheel caster, carpet, black painted  A +\$0
  - VD** 2" hard double wheel caster, carpet, chrome  A +\$0

Step 4. Base/Frame Finish

- L** polished aluminum  A +\$0

Step 5. Fabric

*See application chart and textiles list for fabric usage and numbers. First 2 digits of number indicate fabric line; remaining digit(s) indicate fabric color.*

Price Category 1	+\$0
Price Category 2	+\$39
Price Category 3	+\$73
Price Category 4	+\$113
Price Category 7	+\$180
Price Category 9	+\$591
Price Category B	+\$31
Price Category E	+\$77
Price Category H	+\$184
Price Category R	+\$1072
Price Category V	+\$2028

# Side Chair

EA330  
EA331

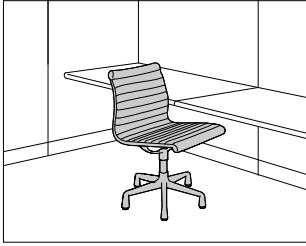

### Product Information

#### Description

This low-back chair has a lightweight aluminum frame with suspended upholstery. It has a 5-star base with 1/2" (GD) glides for hard floors or carpet, swivel mechanism, and fixed seat height.

#### Notes

Chair is tested and warranted for use by persons 300 pounds and under. For description of glide, see Casters and Glides in Appendices. Customer's Own Material (COM) requires 1 1/3 yards. Customer's Own Leather (COL) requires 45 square feet. See Order Information in Appendices.

#### Dimensions

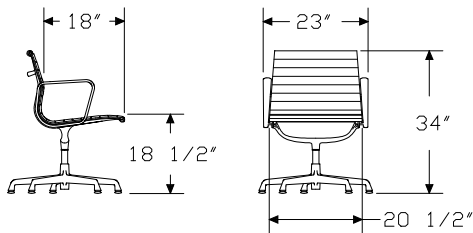

### Specification Information

#### Step 1.

**EA33**

#### Step 2. Arms

**0** no arms  
**1** arms  A

#### Prices for Steps 1-2.

<b>EA330</b>	\$1069
<b>EA331</b>	\$1405

#### Step 3. Base/Frame Finish

**L** polished aluminum + \$0

#### Step 4. Fabric

See application chart and textiles list for fabric usage and numbers. First 2 digits of number indicate fabric line; remaining digit(s) indicate fabric color.

Price Category 1	+ \$0
Price Category 2	+ \$39
Price Category 3	+ \$73
Price Category 4	+ \$113
Price Category 7	+ \$180
Price Category 9	+ \$591
Price Category B	+ \$31
Price Category E	+ \$77
Price Category H	+ \$184
Price Category R	+ \$1072
Price Category V	+ \$2028

Eames® Aluminum Group Side Chair

# Lounge Chair

EA333  
EA338



## Product Information

### Description

This high-back chair has a lightweight aluminum frame with suspended upholstery. It has a 5-star base with 1/2" (GD) glides for hard floors or carpet and fixed seat height.

The tilt-swivel chair includes a headrest upholstered in the specified leather, fabric, or vinyl color.

### Notes

Chair is tested and warranted for use by persons 300 pounds and under. For description of glides, see Casters and Glides in Appendices.

Customer's Own Material (COM) requires 1 3/4 yards for swivel chair and 3 yards for tilt-swivel chair. Customer's Own Leather (COL) requires 50 square feet for swivel chair and 55 square feet for tilt-swivel chair. See Order Information in Appendices.

### Dimensions

#### Swivel

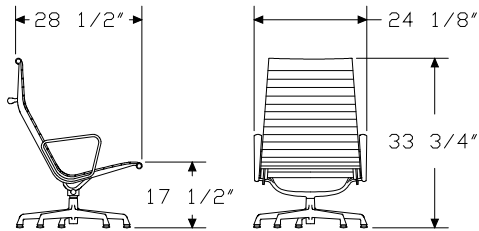

#### Tilt Swivel

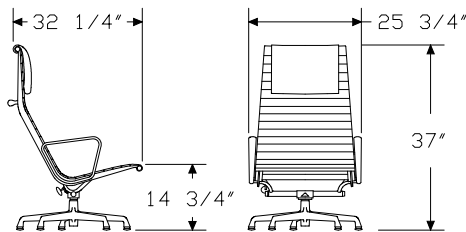

## Specification Information

### Step 1.

**EA33**

### Step 2. Tilt/Arms

- 3** swivel and arms
- 8** tilt swivel, arms, and headrest

### Prices for Steps 1-2.

<b>EA333</b>	\$1635
<b>EA338</b>	\$1771

### Step 3. Base/Frame Finish

<b>L</b> polished aluminum	+\$0
----------------------------	------

### Step 4. Fabric

See application chart and textiles list for fabric usage and numbers. First 2 digits of number indicate fabric line; remaining digit(s) indicate fabric color.

Price Category 1	+\$0
Price Category 2	+\$45
Price Category 3	+\$102
Price Category 4	+\$147
Price Category 7	+\$240
Price Category 9	+\$621
Price Category B	+\$46
Price Category E	+\$115
Price Category H	+\$276
Price Category R	+\$1105
Price Category V	+\$2028

Ottoman

EA323

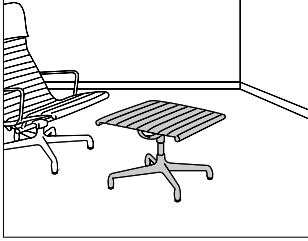

**Product Information**

**Description**

This upholstered ottoman has a lightweight aluminum frame and 1/2" (GD) glides for hard floors or carpet.

**Notes**

For description of glides, see Casters and Glides in Appendices.  
 Customer's Own Material (COM) requires 1 yard. Customer's Own Leather (COL) requires 20 square feet. See Order Information in Appendices.

**Dimensions**

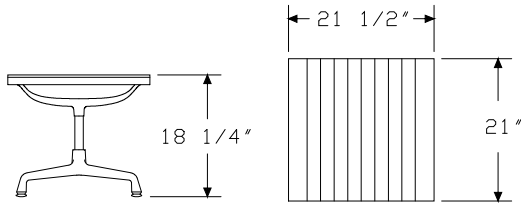

**Specification Information**

**Step 1.**

**EA323** \$782

**Step 2. Base/Frame Finish**

**L** polished aluminum +\$0

**Step 3. Fabric**

See application chart and textiles list for fabric usage and numbers. First 2 digits of number indicate fabric line; remaining digit(s) indicate fabric color.

Price Category 1	+\$0
Price Category 2	+\$23
Price Category 3	+\$45
Price Category 4	+\$68
Price Category 7	+\$109
Price Category 9	+\$281
Price Category B	+\$23
Price Category E	+\$58
Price Category H	+\$138
Price Category R	+\$539
Price Category V	+\$1828

Fame's® Aluminum Group Lounge Chair and Ottoman



**Executive Chair**

**Management Chair**

**Side Chair**

**Lounge Chair and Ottoman**





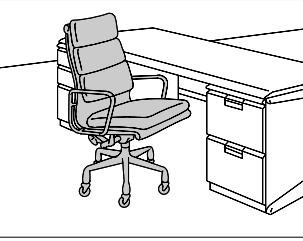

**Product Information**

**Description**

This high-back chair with arms has a lightweight aluminum frame and 2"-thick upholstered foam cushions. It has a 5-star base with casters, tilt-swivel mechanism, and manual seat-height adjustment or pneumatic seat-height adjustment and tilt lock feature.

**Notes**

Chair is tested and warranted for use by persons 300 pounds and under. For description of casters, see Casters and Glides in Appendices. Customer's Own Material (COM) requires 3 yards. Customer's Own Leather (COL) requires 56 square feet. See Order Information in Appendices.

**Dimensions**

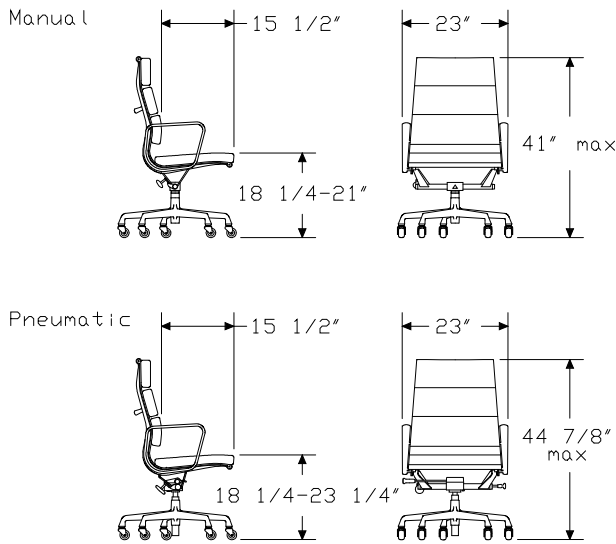

**Specification Information**

**Step 1.**

**EA43**  A

**Step 2. Seat-Height Adjustment**

**7** manual seat-height adjustment  A

**7P** pneumatic seat-height adjustment  A

**Prices for Steps 1-2.**

<b>EA437</b>	\$2686
<b>EA437P</b>	\$2826

**Step 3. Casters**

**CA** 2" single wheel caster, hard floors or carpet  A +\$0

**UD** 2" hard double wheel caster, carpet, black painted  A +\$0

**VD** 2" hard double wheel caster, carpet, chrome  A +\$0

**Step 4. Base/Frame Finish**

**L** polished aluminum  A +\$0

**Step 5. Fabric**

See application chart and textiles list for fabric usage and numbers. First 2 digits of number indicate fabric line; remaining digit(s) indicate fabric color.

Price Category 1	+\$0
Price Category 2	+\$57
Price Category 3	+\$135
Price Category 4	+\$216
Price Category 7	+\$349
Price Category 9	+\$608
Price Category B	+\$81
Price Category E	+\$201
Price Category F	+\$241
Price Category G	+\$362
Price Category H	+\$482
Price Category R	+\$1748
Price Category V	+\$2028

# Management Chair

EA434  
EA435

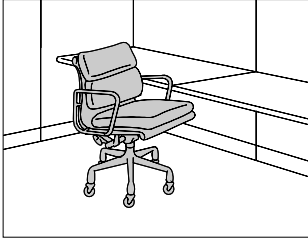

Eames® Soft Pad Group Management Chair

## Product Information

### Description

This low-back chair with arms has a lightweight aluminum frame and 2"-thick upholstered foam cushions. It has a 5-star base, tilt-swivel mechanism, and manual seat-height adjustment or pneumatic seat-height adjustment and tilt lock feature. The chair is available with casters or glides. The chair with glides includes 1/2" (GD) glides for hard floors or carpet.

### Notes

Chair is tested and warranted for use by persons 300 pounds and under. For description of casters and glides, see Casters and Glides in Appendices.

Customer's Own Material (COM) requires 2 1/2 yards. Customer's Own Leather (COL) requires 45 square feet. See Order Information in Appendices.

## Dimensions

### Casters

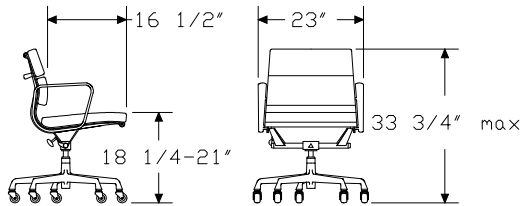

### Glides

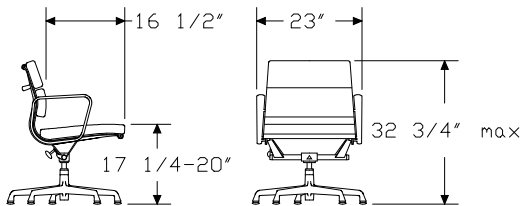

### Pneumatic

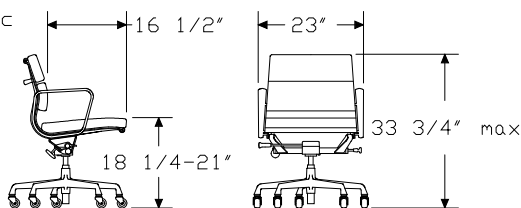

## Specification Information

### Step 1.

**EA43**

### Step 2. Casters/Glides/Seat-Height Adjustment

- 5** casters with manual seat-height adjustment
- 4** glides with manual seat-height adjustment
- 5P** casters with pneumatic seat-height adjustment

### Prices for Steps 1-2.

<b>EA435</b>	\$2247
<b>EA434</b>	\$2247
<b>EA435P</b>	\$2387

### Step 3. Casters

For casters with manual seat-height adjustment (5) or casters with pneumatic seat-height adjustment (5P)

- CA** 2" single wheel caster, hard floors or carpet  +\$0
- UD** 2" hard double wheel caster, carpet, black painted  +\$0
- VD** 2" hard double wheel caster, carpet, chrome  +\$0

### Step 4. Base/Frame Finish

- L** polished aluminum  +\$0

### Step 5. Fabric

See application chart and textiles list for fabric usage and numbers. First 2 digits of number indicate fabric line; remaining digit(s) indicate fabric color.

Price Category 1	+\$0
Price Category 2	+\$57
Price Category 3	+\$125
Price Category 4	+\$192
Price Category 7	+\$288
Price Category 9	+\$574
Price Category B	+\$58
Price Category E	+\$144
Price Category F	+\$201
Price Category G	+\$259
Price Category H	+\$345
Price Category R	+\$1100
Price Category V	+\$2028

# Side Chair

EA430  
EA431

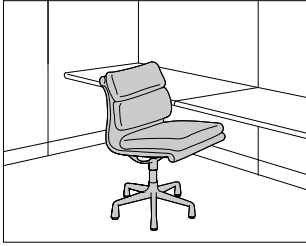

### Product Information

#### Description

This low-back chair has a lightweight aluminum frame and 2"-thick upholstered foam cushions. It has a 5-star base with 1/2" (GD) glides for hard floors or carpet, swivel mechanism, and fixed seat height.

#### Notes

Chair is tested and warranted for use by persons 300 pounds and under. For description of glides, see Casters and Glides in Appendices. Customer's Own Material (COM) requires 2 1/2 yards. Customer's Own Leather (COL) requires 45 square feet. See Order Information in Appendices.

#### Dimensions

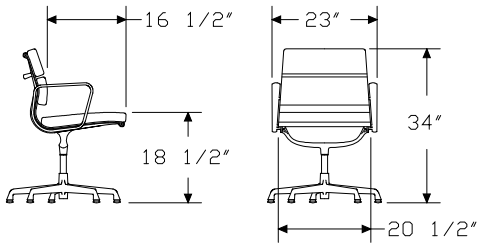

### Specification Information

#### Step 1.

**EA43**

#### Step 2. Arms

**0** no arms  
**1** arms  A

#### Prices for Steps 1-2.

**EA430** \$1936  
**EA431** \$2271

#### Step 3. Base/Frame Finish

**L** polished aluminum +\$0

#### Step 4. Fabric

See application chart and textiles list for fabric usage and numbers. First 2 digits of number indicate fabric line; remaining digit(s) indicate fabric color.

Price Category 1	+\$0
Price Category 2	+\$57
Price Category 3	+\$125
Price Category 4	+\$192
Price Category 7	+\$288
Price Category 9	+\$574
Price Category B	+\$58
Price Category E	+\$144
Price Category F	+\$201
Price Category G	+\$259
Price Category H	+\$345
Price Category R	+\$1100
Price Category V	+\$2028

Eames® Soft Pad Group Side Chair

# Lounge Chair

EA433  
EA438

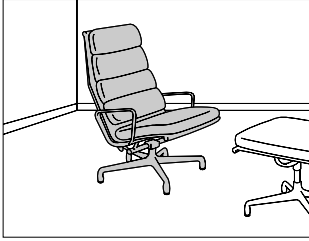

### Product Information

#### Description

This high-back chair has a lightweight aluminum frame and 2"-thick upholstered foam cushions. It has a 5-star base with 1/2" (GD) glides for hard floors or carpet and a fixed seat height.

#### Notes

Chair is tested and warranted for use by persons 300 pounds and under. For description of glides, see Casters and Glides in Appendices.

Customer's Own Material (COM) requires 3 yards for 3-cushion chair and 4 yards for 4-cushion chair. Customer's Own Leather (COL) requires 56 square feet for 3-cushion chair and 63 square feet for 4-cushion chair. See Order Information in Appendices.

### Dimensions

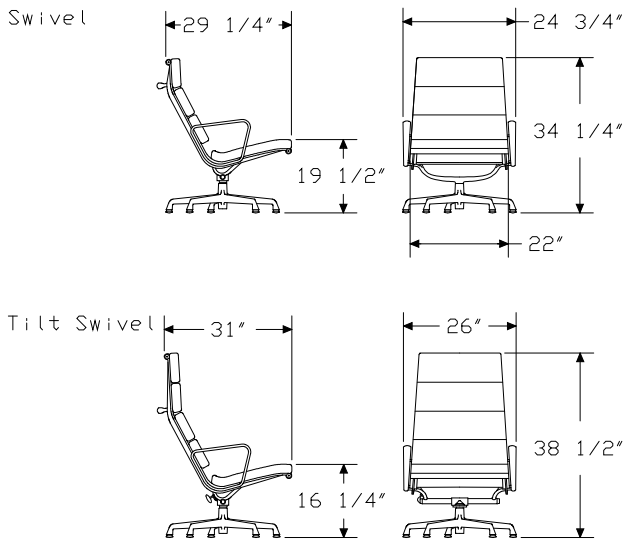

### Specification Information

#### Step 1.

#### EA43

#### Step 2. Tilt/Number of Cushions/Arms

- 3** swivel, 3 cushions, and arms
- 8** tilt swivel, 4 cushions, and arms

#### Prices for Steps 1-2.

<b>EA433</b>	\$2847
<b>EA438</b>	\$2888

#### Step 3. Base/Frame Finish

<b>L</b> polished aluminum	+\$0
----------------------------	------

#### Step 4. Fabric

See application chart and textiles list for fabric usage and numbers. First 2 digits of number indicate fabric line; remaining digit(s) indicate fabric color.

Price Category 1	+\$0
Price Category 2	+\$57
Price Category 3	+\$135
Price Category 4	+\$216
Price Category 7	+\$349
Price Category 9	+\$630
Price Category B	+\$81
Price Category E	+\$201
Price Category F	+\$281
Price Category G	+\$362
Price Category H	+\$482
Price Category R	+\$1748
Price Category V	+\$2028

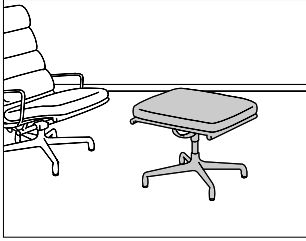

**Product Information**

**Description**

This ottoman has a lightweight aluminum frame, a 2"-thick upholstered foam cushion, and 1/2" (GD) glides for hard floors or carpet.

**Notes**

For description of glides, see Casters and Glides in Appendices.  
 Customer's Own Material (COM) requires 1 1/4 yards. Customer's Own Leather (COL) requires 27 square feet. See Order Information in Appendices.

**Dimensions**

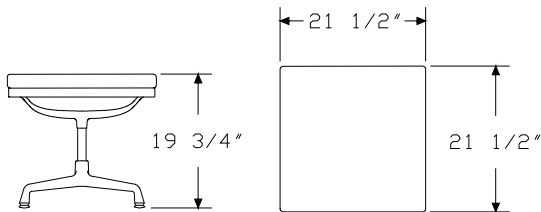

**Specification Information**

**Step 1.**

**EA423** \$1202

**Step 2. Base/Frame Finish**

**L** polished aluminum +\$0

**Step 3. Fabric**

See application chart and textiles list for fabric usage and numbers. First 2 digits of number indicate fabric line; remaining digit(s) indicate fabric color.

Price Category 1	+\$0
Price Category 2	+\$56
Price Category 3	+\$85
Price Category 4	+\$107
Price Category 7	+\$139
Price Category 9	+\$308
Price Category B	+\$29
Price Category E	+\$72
Price Category F	+\$101
Price Category G	+\$130
Price Category H	+\$173
Price Category R	+\$550
Price Category V	+\$1828







# Executive Work Chair

ES204

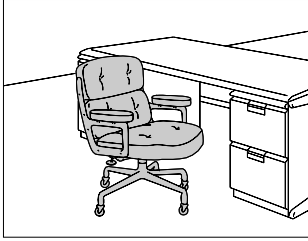

## Product Information

### Description

This upholstered chair has contoured seat and back cushions and padded armrests. The seat has a 4 1/2"-thick foam cushion and the back has 2 3"-thick foam cushions. It has a 5-star base, tilt-swivel mechanism, and seat-height adjustment. The chair is available with casters or glides. The chair with glides includes 1/2" (GD) glides for hard floors or carpet.

### Notes

Chair is tested and warranted for use by persons 300 pounds and under. For description of casters and glides, see Casters and Glides in Appendices.

Customer's Own Material (COM) requires 3 yards. Customer's Own Leather (COL) requires 52 square feet. See Order Information in Appendices.

## Dimensions

### Casters

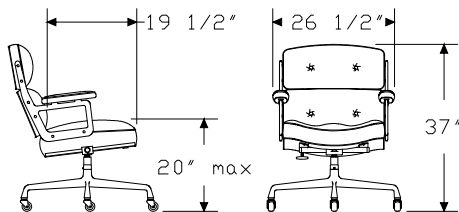

### Glides

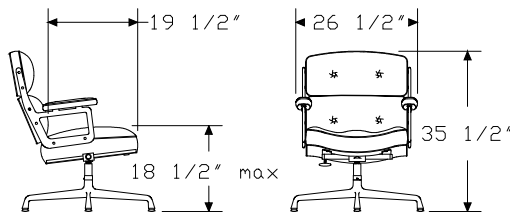

## Specification Information

### Step 1.

**ES204** A \$3509

### Step 2. Casters/Glides

<b>CA</b>	2" single wheel caster, hard floors or carpet	<span style="border: 1px solid black; padding: 0 2px;">A</span>	+\$0
<b>GD</b>	1/2" glide, hard floors or carpet	<span style="border: 1px solid black; padding: 0 2px;">A</span>	+\$0
<b>UD</b>	2" hard double wheel caster, carpet, black painted	<span style="border: 1px solid black; padding: 0 2px;">A</span>	+\$0
<b>VD</b>	2" hard double wheel caster, carpet, chrome	<span style="border: 1px solid black; padding: 0 2px;">A</span>	+\$0

### Step 3. Base/Frame Finish

<b>L</b>	polished aluminum	<span style="border: 1px solid black; padding: 0 2px;">A</span>	+\$0
----------	-------------------	---	------

### Step 4. Fabric

See application chart and textiles list for fabric usage and numbers. First 2 digits of number indicate fabric line; remaining digit(s) indicate fabric color.

Price Category 1	+\$0
Price Category 2	+\$59
Price Category 3	+\$135
Price Category 4	+\$216
Price Category 7	+\$349
Price Category 9	+\$630
Price Category B	+\$81
Price Category E	+\$201
Price Category F	+\$261
Price Category G	+\$362
Price Category H	+\$482
Price Category R	+\$1748
Price Category V	+\$2028







# Tandem Sling Seating

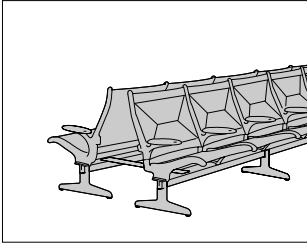

## Product Information

### Description

This seating product combines either a single row or back-to-back rows of seats or seats/tables in 2- to 7-unit configurations. The base is a black T-beam with polished aluminum legs and nylon glides; the sling seat is vinyl; the table is white laminate with a black vinyl edge; and the arm pads are black urethane. Shipped assembled.

The back-to-back seating product is shipped assembled as 2 single rows with 2 black connectors and hardware to connect the back-to-back rows. A back-to-back configuration that includes a table is shipped with a one-piece table to cover the back-to-back depth; attachment hardware is included.

A fire-retardant sling meets CAL 133 requirements; the sling has seats upholstered in approved fire-retardant vinyl.

### Notes

For configuration options, sequence of components is from left to right when facing unit.

For 2- to 5-unit configurations, 1 table can be specified. For 6- and 7-unit configurations, 2 tables can be specified (1 for each end).

For other configurations, contact Herman Miller Options.

To retrofit single-row seating to back-to-back seating, order back-to-back base connector (TS708) separately.

## Dimensions

### Single

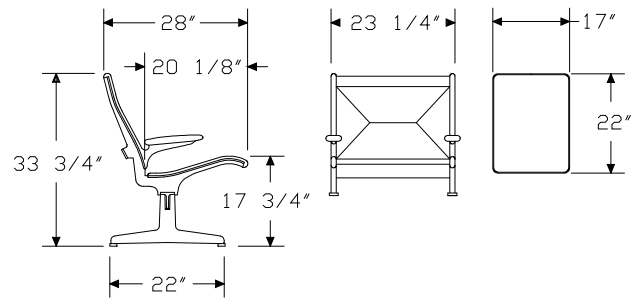

### Back to Back

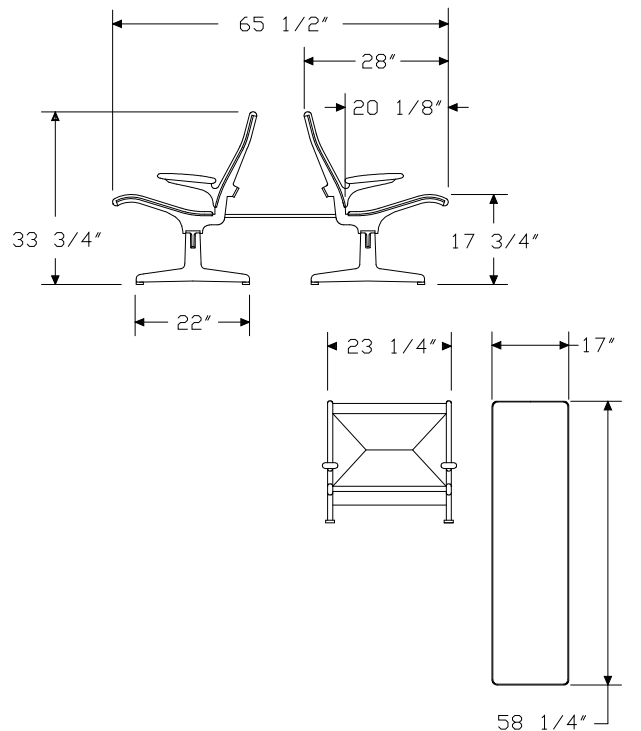

**Specification Information**

Step 1.

TS  A

Step 2. Type

- 1 single, not fire retardant  A
- 2 back to back, not fire retardant  A
- 3 single, fire retardant  A
- 4 back to back, fire retardant  A

Step 3. Configuration

- 2SSNNNNN 2 units (2 seats)  A
- 2STNNNNN 2 units (1 seat, 1 table)  A
- 2TSNNNNN 2 units (1 table, 1 seat)  A
- 3SSNNNNN 3 units (3 seats)  A
- 3SSTNNNN 3 units (2 seats, 1 table)  A
- 3STSNNNN 3 units (1 seat, 1 table, 1 seat)  A
- 3TSSNNNN 3 units (1 table, 2 seats)  A
- 4SSSSNNN 4 units (4 seats)  A
- 4SSSTNNN 4 units (3 seats, 1 table)  A
- 4SSTSNNN 4 units (2 seats, 1 table, 1 seat)  A
- 4STSSNNN 4 units (1 seat, 1 table, 2 seats)  A
- 4TSSSNNN 4 units (1 table, 3 seats)  A
- 5SSSSSNN 5 units (5 seats)  A
- 5SSSSTNN 5 units (4 seats, 1 table)  A
- 5SSSTSNN 5 units (3 seats, 1 table, 1 seat)  A
- 5SSTSSNN 5 units (2 seats, 1 table, 2 seats)  A
- 5STSSSNN 5 units (1 seat, 1 table, 3 seats)  A
- 5TSSSSNN 5 units (1 table, 4 seats)  A
- 6SSSSSSN 6 units (6 seats)  A
- 6SSSSSTN 6 units (5 seats, 1 table)  A
- 6SSSSTSN 6 units (4 seats, 1 table, 1 seat)  A
- 6SSSTSSN 6 units (3 seats, 1 table, 2 seats)  A
- 6SSTSSSN 6 units (2 seats, 1 table, 3 seats)  A
- 6STSSSSN 6 units (1 seat, 1 table, 4 seats)  A
- 6TSSSSSN 6 units (1 table, 5 seats)  A
- 6TSSSSTN 6 units (1 table, 4 seats, 1 table)  A
- 7SSSSSSS 7 units (7 seats)  A
- 7SSSSSST 7 units (6 seats, 1 table)  A
- 7SSSSSTS 7 units (5 seats, 1 table, 1 seat)  A
- 7SSSSTSS 7 units (4 seats, 1 table, 2 seats)  A
- 7SSSTSSS 7 units (3 seats, 1 table, 3 seats)  A
- 7SSTSSSS 7 units (2 seats, 1 table, 4 seats)  A
- 7TSSSSSS 7 units (1 seat, 1 table, 5 seats)  A
- 7TSSSSSS 7 units (1 table, 6 seats)  A
- 7TSSSSST 7 units (1 table, 5 seats, 1 table)  A

Prices for Steps 1-3.

TS12SSNNNNN	\$3840
TS12STNNNNN	\$3840
TS12TSNNNNN	\$3840
TS13SSNNNNN	\$5016
TS13SSTNNNN	\$5016
TS13STSNNNN	\$5016
TS13TSSNNNN	\$5016
TS14SSNNNNN	\$6378
TS14SSSTNNN	\$6378
TS14SSTSNNN	\$6378
TS14TSSNNNN	\$6378
TS14TSSSSNN	\$6378
TS15SSSSSNN	\$7679
TS15SSSSTNN	\$7679
TS15SSSSTSN	\$7679
TS15SSTSSNN	\$7679
TS15STSSSNN	\$7679
TS15TSSSSNN	\$7679
TS16SSSSSSN	\$8918
TS16SSSSSSTN	\$8918
TS16SSSSSTSN	\$8918
TS16SSSTSSN	\$8918
TS16SSTSSSN	\$8918
TS16TSSSSSN	\$8918
TS16TSSSSTN	\$8918
TS17SSSSSSS	\$10280
TS17SSSSSST	\$10280
TS17SSSSSTS	\$10280
TS17SSSSTSS	\$10280
TS17SSTSSSS	\$10280
TS17STSSSSS	\$10280
TS17TSSSSSS	\$10280
TS17TSSSSTT	\$10280
TS22SSNNNNN	\$7833
TS22STNNNNN	\$7833
TS22TSNNNNN	\$7833
TS23SSNNNNN	\$10187
TS23SSTNNNN	\$10187
TS23STSNNNN	\$10187
TS23TSSNNNN	\$10187
TS24SSNNNNN	\$12911
TS24SSSTNNN	\$12911
TS24SSTSNNN	\$12911
TS24TSSNNNN	\$12911

Tandem Sling Seating *continued*

TS24TSSNNN	\$12911	TS36TSSSSN	\$9275
TS25SSSSNN	\$15512	TS36TSSSSN	\$9275
TS25SSSSTNN	\$15512	TS36TSSSSTN	\$9275
TS25SSSSTSN	\$15512	TS37SSSSSS	\$10697
TS25SSTSSNN	\$15512	TS37SSSSSST	\$10697
TS25STSSSNN	\$15512	TS37SSSSSTS	\$10697
TS25TSSSNN	\$15512	TS37SSSSTSS	\$10697
TS26SSSSSSN	\$17988	TS37SSSTSSS	\$10697
TS26SSSSSTN	\$17988	TS37SSTSSSS	\$10697
TS26SSSSSTSN	\$17988	TS37STSSSSS	\$10697
TS26SSSSTSSN	\$17988	TS37TSSSSSS	\$10697
TS26STSSSNN	\$17988	TS37TSSSSST	\$10697
TS26TSSSNN	\$17988	TS42SNNNNN	\$8072
TS26TSSSSTN	\$17988	TS42STNNNNN	\$8072
TS27SSSSSSS	\$20713	TS42TSNNNNN	\$8072
TS27SSSSSST	\$20713	TS43SSNNNNN	\$10544
TS27SSSSSTS	\$20713	TS43SSTNNNN	\$10544
TS27SSSSTSS	\$20713	TS43STNNNNN	\$10544
TS27SSTSSSS	\$20713	TS43TSSNNNN	\$10544
TS27STSSSSS	\$20713	TS44SSSSNNN	\$13388
TS27TSSSSSS	\$20713	TS44SSSTNNN	\$13388
TS27TSSSSST	\$20713	TS44SSTSNNN	\$13388
TS32SNNNNNN	\$3960	TS44STSSNNN	\$13388
TS32STNNNNN	\$3960	TS44TSSSNNN	\$13388
TS32TSNNNNN	\$3960	TS45SSSSSNN	\$16107
TS33SSNNNNN	\$5196	TS45SSSSTNN	\$16107
TS33SSTNNNN	\$5196	TS45SSSSTSN	\$16107
TS33STSNNNN	\$5196	TS45SSTSSNN	\$16107
TS33TSSNNNN	\$5196	TS45TSSSNNN	\$16107
TS34SSSSNNN	\$6617	TS45TSSSSNN	\$16107
TS34SSSSTNN	\$6617	TS46SSSSSSN	\$18703
TS34SSTSNNN	\$6617	TS46SSSSSTN	\$18703
TS34STSSNNN	\$6617	TS46SSSSTSN	\$18703
TS34TSSSNNN	\$6617	TS46SSSSTSSN	\$18703
TS35SSSSSNN	\$7976	TS46SSTSSSN	\$18703
TS35SSSSTNN	\$7976	TS46TSSSSSN	\$18703
TS35SSSSTSN	\$7976	TS46TSSSSSTN	\$18703
TS35SSTSSNN	\$7976	TS47SSSSSSS	\$21545
TS35STSSSNN	\$7976	TS47SSSSSST	\$21545
TS35TSSSNN	\$7976	TS47SSSSSTS	\$21545
TS36SSSSSSN	\$9275	TS47SSSSTSS	\$21545
TS36SSSSSTN	\$9275	TS47SSSTSSS	\$21545
TS36SSSSTSN	\$9275	TS47STSSSSS	\$21545
TS36SSSSTSSN	\$9275	TS47TSSSSSS	\$21545
TS36SSTSSNN	\$9275	TS47TSSSSST	\$21545

Fames® Tandem Sling Seating

Tandem Sling Seating *continued*

**Eames® Tandem Sling Seating**

---

Step 4. Fabric	
Price Category 1	+\$0

# Base Connector, Back to Back

TS708

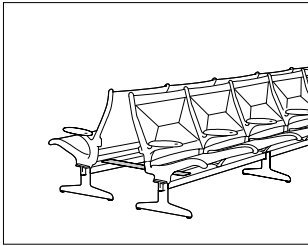

### Product Information

#### Description

This retrofit connector joins 2 single rows of tandem sling seating products placed in back-to-back rows. The number of units and configuration must be the same for each row. Package contains 2 black connectors and hardware.

#### Dimensions

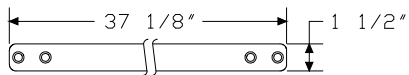

### Specification Information

#### Step 1.

TS708 A

\$156

Fames® Tandem Sling Seating



**Lounge Seating**

**Sofas**

**Molded Plywood Chairs**

**Molded Plastic Chairs**

**Wire Chair**



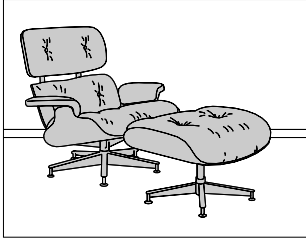

**Product Information**

**Description**

This fixed-height chair has a molded veneer seat and back shell; the ottoman has a molded veneer shell. Both the chair and ottoman have 6"-thick foam cushions with leather upholstery and a black enameled base with polished aluminum trim. The chair has a swivel mechanism.

**Notes**

Customer's Own Leather (COL) requires 55 square feet. See Order Information in Appendices.

**Dimensions**

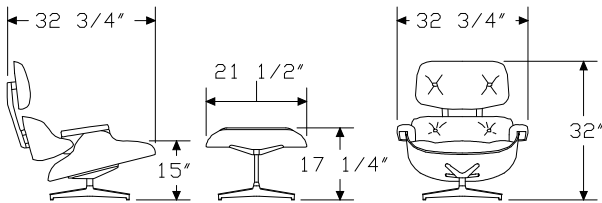

**Specification Information**

**Step 1.**

**ES67071** [A] \$3908

**Step 2. Shell Finish**

<b>CX</b>	natural cherry [A]	+\$0
<b>OU</b>	walnut [A]	+\$0
<b>V3</b>	cherry [A]	+\$0
<b>9N</b>	santos palisander [A]	+\$1070

**Step 3. Leather**

See application chart and textiles list for fabric usage and numbers. First 2 digits of number indicate fabric line; remaining digit(s) indicate fabric color.

Price Category 7	+\$300
Price Category 9	+\$612
Price Category R	+\$1045
Price Category V	+\$2028

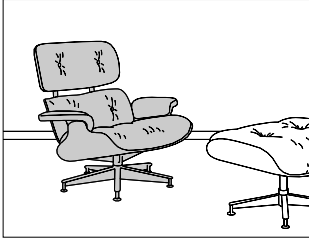

**Product Information**

**Description**

This fixed-height chair has a molded veneer seat and back shell. It has 6"-thick foam cushions with leather upholstery, a black enameled base with polished aluminum trim, and a swivel mechanism.

**Notes**

Customer's Own Leather (COL) requires 40 square feet. See Order Information in Appendices.

**Dimensions**

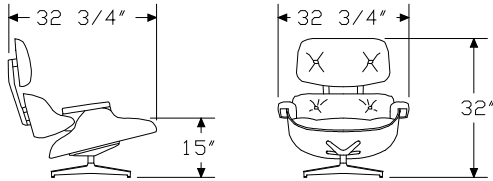

**Specification Information**

**Step 1.**

**ES670** [A] \$3131

**Step 2. Shell Finish**

- CX** natural cherry [A] +\$0
- OU** walnut [A] +\$0
- V3** cherry [A] +\$0
- 9N** santos palisander [A] +\$870

**Step 3. Leather**

See application chart and textiles list for fabric usage and numbers. First 2 digits of number indicate fabric line; remaining digit(s) indicate fabric color.

- Price Category 7 +\$288
- Price Category 9 +\$448
- Price Category R +\$990
- Price Category V +\$1928

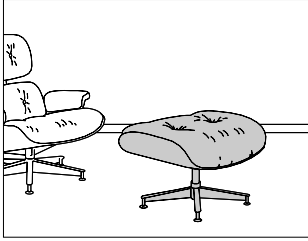

**Product Information**

**Description**

This ottoman has a molded veneer shell, 6"-thick foam cushion with leather upholstery, and black enameled base with polished aluminum trim.

**Notes**

Customer's Own Leather (COL) requires 15 square feet. See Order Information in Appendices.

**Dimensions**

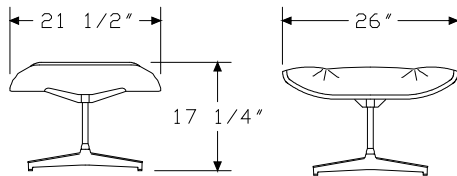

**Specification Information**

**Step 1.**

**ES671** A \$1144

**Step 2. Shell Finish**

<b>CX</b>	natural cherry <span style="border: 1px solid black; padding: 0 2px;">A</span>	+\$0
<b>OU</b>	walnut <span style="border: 1px solid black; padding: 0 2px;">A</span>	+\$0
<b>V3</b>	cherry <span style="border: 1px solid black; padding: 0 2px;">A</span>	+\$0
<b>9N</b>	santos palisander <span style="border: 1px solid black; padding: 0 2px;">A</span>	+\$318

**Step 3. Leather**

See application chart and textiles list for fabric usage and numbers. First 2 digits of number indicate fabric line; remaining digit(s) indicate fabric color.

Price Category 7	+\$107
Price Category 9	+\$164
Price Category R	+\$452
Price Category V	+\$1828

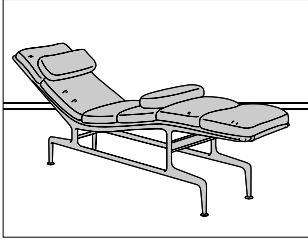

**Product Information**

**Description**

This chaise has 6 2"-thick foam cushions with leather upholstery supported by a fabric sling. It has nylon glides and includes 2 loose cushions. Frame and base finish are eggplant.

**Dimensions**

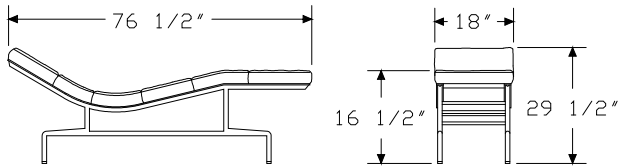

**Specification Information**

**Step 1.**

**ES106** A \$5066

**Step 2. Leather**

*See application chart and textiles list for fabric usage and numbers. First 2 digits of number indicate leather line; remaining digit(s) indicate leather color.*

Price Category 9 +\$885

Price Category R +\$2595

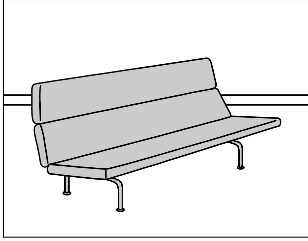

**Product Information**

**Description**

This sofa has 2½"-thick upholstered foam cushions supported by a black enameled frame. It has polished chrome-plated legs and stainless steel glides. All fabrics are railroaded.

**Notes**

Customer's Own Material (COM) requires 6 yards. See Order Information in Appendices.

**Dimensions**

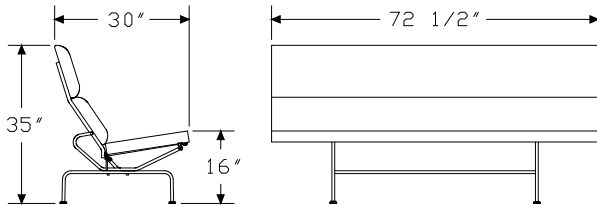

**Specification Information**

**Step 1.**

**473** A \$4060

**Step 2. Fabric**

See application chart and textiles list for fabric usage and numbers. First 2 digits of number indicate fabric line; remaining digit(s) indicate fabric color.

Price Category 1	+\$0
Price Category 2	+\$80
Price Category 3	+\$110
Price Category 4	+\$208
Price Category B	+\$138
Price Category E	+\$345
Price Category F	+\$482
Price Category G	+\$620
Price Category H	+\$826

Sofa

ES108  
ES110

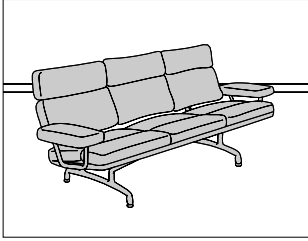

Eames® Classic Sofas

**Product Information**

**Description**

This sofa has 2"-thick upholstered foam cushions and a polished chrome-plated frame with nylon glides. The back panels are hand-finished solid walnut or solid teak.

**Notes**

Customer's Own Material (COM) requires 4½ yards for 2-seat sofa and 6½ yards for 3-seat sofa. Customer's Own Leather (COL) requires 100 square feet for 2-seat sofa and 125 square feet for 3-seat sofa. See Order Information in Appendices.

**Dimensions**

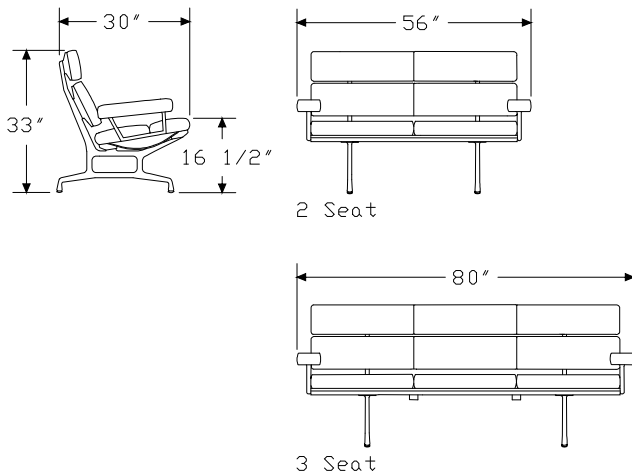

**Specification Information**

**Step 1.**

**ES1**  A

**Step 2. Number of Seats**

**08** 3 seats  A

**10** 2 seats  A

**Prices for Steps 1-2.**

<b>ES108</b>	\$9964
<b>ES110</b>	\$8251

**Step 3. Back Finish**

**OT** teak  A +\$0

**OU** walnut  A +\$0

**Step 4. Base Finish**

**CD** polished aluminum  A +\$0

**Step 5. Fabric**

See application chart and textiles list for fabric usage and numbers. First 2 digits of number indicate fabric line; remaining digit(s) indicate fabric color.

	<b>08</b>	<b>10</b>
Price Category 1	+\$0	0
Price Category 2	+\$146	129
Price Category 3	+\$168	149
Price Category 4	+\$274	224
Price Category 7	+\$608	516
Price Category 9	+\$1611	1271
Price Category R	+\$3158	2168

# Lounge Chair, Metal Legs

LCM.

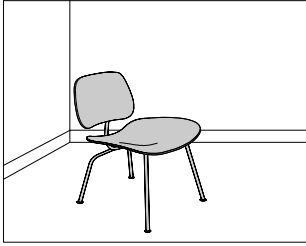

## Product Information

### Description

This 26<sup>1</sup>/<sub>2</sub>"-high molded plywood chair has natural face veneers, hardwood inner plies, and a 5-ply seat and back. It has a polished chrome-plated 4-leg base and self-leveling nylon glides.

### Notes

Finishes 11, 12, 13, 15, Z8, Z9, and ZQ are stain on birch veneer. These stains allow the wood grain to show through; inner plies are visible. Natural variations in wood grain may affect the appearance of these stain colors.

Avoid placement in direct sunlight.

### Dimensions

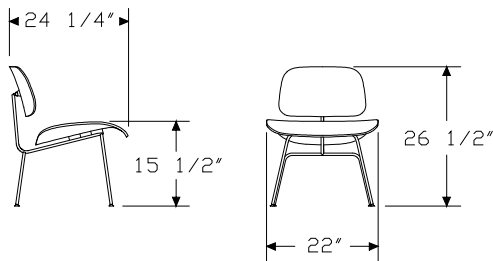

## Specification Information

### Step 1.

**LCM.** [A] \$546

### Step 2. Shell Finish

#### Wood Veneer

<b>AV</b>	light ash [A]	+\$0
<b>OU</b>	walnut [A]	+\$0
<b>CX</b>	natural cherry [A]	+\$35
<b>11</b>	red stain [A]	+\$90
<b>15</b>	black stain [A]	+\$90
<b>9N</b>	santos palisander [A]	+\$285

Fame's® Classic Molded Plywood Chairs

# Lounge Chair, Wood Legs

LCW.

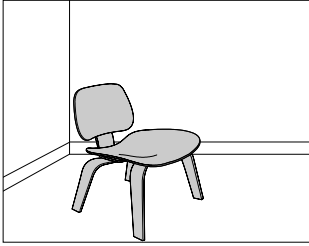

Eames® Classic Molded Plywood Chairs

## Product Information

### Description

This 26½"-high molded plywood chair has natural face veneers, hardwood inner plies, a 5-ply seat and back, and 8-ply legs.

### Notes

Finishes 11, 12, 13, 15, Z8, Z9, and ZQ are stain on birch veneer. These stains allow the wood grain to show through; inner plies are visible. Natural variations in wood grain may affect the appearance of these stain colors.

Avoid placement in direct sunlight.

### Dimensions

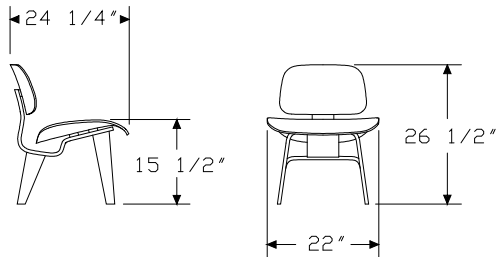

## Specification Information

### Step 1.

**LCW.**  **A** \$799

### Step 2. Finish

<b>AV</b>	light ash <input type="checkbox"/> <b>A</b>	+\$0
<b>OU</b>	walnut <input type="checkbox"/> <b>A</b>	+\$0
<b>CX</b>	natural cherry <input type="checkbox"/> <b>A</b>	+\$45
<b>11</b>	red stain <input type="checkbox"/> <b>A</b>	+\$129
<b>15</b>	black stain <input type="checkbox"/> <b>A</b>	+\$129
<b>9N</b>	santos palisander <input type="checkbox"/> <b>A</b>	+\$575

# Dining Chair, Metal Legs

DCM.

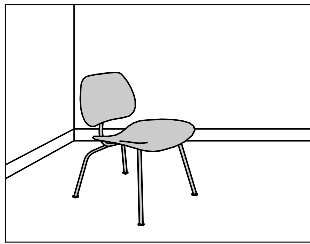

### Product Information

#### Description

This 29½"-high molded plywood chair has natural face veneers, hardwood inner plies, and a 5-ply seat and back. It has a polished chrome-plated 4-leg base and self-leveling nylon glides.

#### Notes

Finishes 11, 12, 13, 15, Z8, Z9, and ZQ are stain on birch veneer. These stains allow the wood grain to show through; inner plies are visible. Natural variations in wood grain may affect the appearance of these stain colors.

Avoid placement in direct sunlight.

#### Dimensions

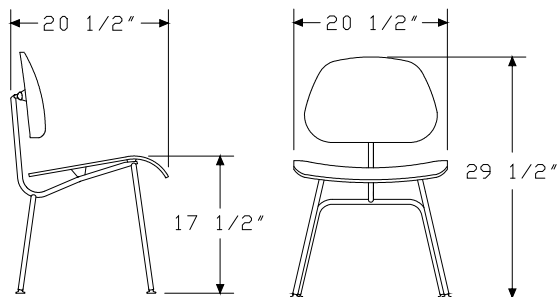

### Specification Information

#### Step 1.

**DCM.**  A \$492

#### Step 2. Shell Finish

##### Wood Veneer

<b>AV</b>	light ash <input type="checkbox"/> A	+\$0
<b>OU</b>	walnut <input type="checkbox"/> A	+\$0
<b>CX</b>	natural cherry <input type="checkbox"/> A	+\$35
<b>11</b>	red stain <input type="checkbox"/> A	+\$90
<b>15</b>	black stain <input type="checkbox"/> A	+\$90
<b>9N</b>	santos palisander <input type="checkbox"/> A	+\$285

Fame's® Classic Molded Plywood Chairs

# Dining Chair, Wood Legs

DCW.

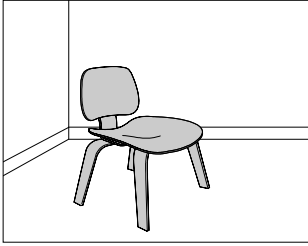

## Product Information

### Description

This 28<sup>3</sup>/<sub>4</sub>"-high molded plywood chair has natural face veneers, hardwood inner plies, a 5-ply seat and back, and 8-ply legs.

### Notes

Finishes 11, 12, 13, 15, Z8, Z9, and ZQ are stain on birch veneer. These stains allow the wood grain to show through; inner plies are visible. Natural variations in wood grain may affect the appearance of these stain colors.

Avoid placement in direct sunlight.

### Dimensions

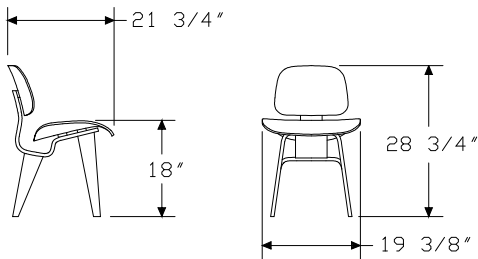

## Specification Information

### Step 1.

**DCW.**  **A** \$749

### Step 2. Finish

<b>AV</b>	light ash <input type="checkbox"/> <b>A</b>	+\$0
<b>OU</b>	walnut <input type="checkbox"/> <b>A</b>	+\$0
<b>CX</b>	natural cherry <input type="checkbox"/> <b>A</b>	+\$45
<b>11</b>	red stain <input type="checkbox"/> <b>A</b>	+\$129
<b>15</b>	black stain <input type="checkbox"/> <b>A</b>	+\$129
<b>9N</b>	santos palisander <input type="checkbox"/> <b>A</b>	+\$575

# Molded Plastic Side Chair

DSR.  
DSS.  
DSW.  
DSX.

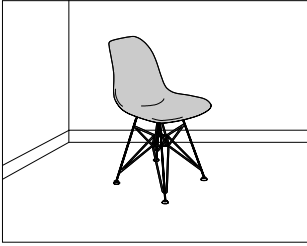

## Product Information

### Description

This chair has a single-piece shell with waterfall edges and molded seat and flexible back. Base options include a wire base, 4-leg base, a dowel-leg base, or a stacking/ganging base. The dowel-leg base has maple legs with non-adjustable nylon glides.

### Notes

Stacking/ganging base chairs can stack up to 14 high.

## Dimensions

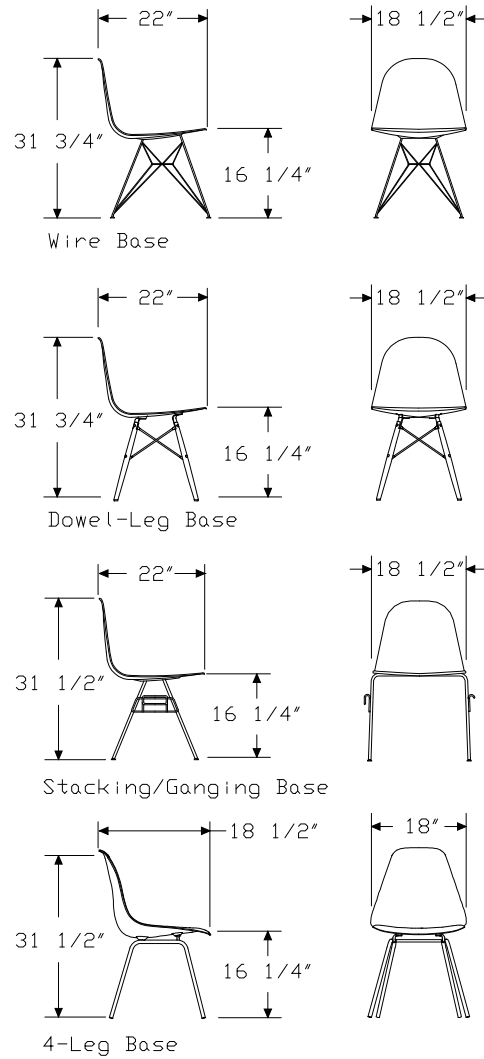

Eames® Classic Molded Plastic Chairs

# Molded Plastic Side Chair *continued*

## Specification Information

### Step 1.

**DS**

### Step 2. Base Option

- R.** wire base
- S.** stacking/ganging base
- W.** dowel-leg base
- X.** 4-leg base

### Prices for Steps 1-2.

<b>DSR.</b>	\$284
<b>DSS.</b>	\$256
<b>DSW.</b>	\$440
<b>DSX.</b>	\$311

### Step 3. Base Finish

*For wire base (R.), stacking/ganging base (S.), or 4-leg base (X.)*

**CH** chrome  +\$0

*For dowel-leg base (W.)*

**BU** black umber  +\$0

### Step 4. Seat/Back Finish

<b>4T</b>	aqua sky <input type="checkbox"/>	+\$0
<b>5B</b>	java <input type="checkbox"/>	+\$0
<b>6Y</b>	wafer <input type="checkbox"/>	+\$0
<b>92</b>	greystone <input type="checkbox"/>	+\$0
<b>9J</b>	sparrow <input type="checkbox"/>	+\$0
<b>ZA</b>	black <input type="checkbox"/>	+\$0
<b>ZE</b>	red <input type="checkbox"/>	+\$0
<b>ZF</b>	white <input type="checkbox"/>	+\$0
<b>ZH</b>	light blue <input type="checkbox"/>	+\$0
<b>ZS</b>	lime green <input type="checkbox"/>	+\$0

### Step 5. Glide Option

*For wire base (R.), stacking/ganging base (S.), or 4-leg base (X.)*

<b>E8</b>	standard glide <input type="checkbox"/>	+\$0
<b>E9</b>	standard glide with felt bottom <input type="checkbox"/>	+\$0

# Dolly

# DOLLY.

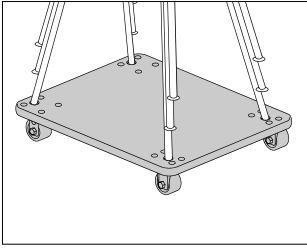

### Product Information

#### Description

This chair dolly stores and transports up to 28 Eames® plastic side chairs with the stacking/ganging base option. It is made of plywood and has 2 locking and 2 non-locking casters.

#### Notes

Single dolly supports 1 stack of 14 chairs. Double dolly supports 2 stacks of 14 chairs.

#### Dimensions

### Specification Information

#### Step 1.

**DOLLY.**  A

#### Step 2. Type

**A** single  A

**B** double  A

#### Prices for Steps 1-2.

<b>DOLLY. A</b>	\$450
<b>B</b>	\$525

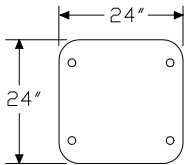

A (Single)

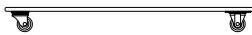
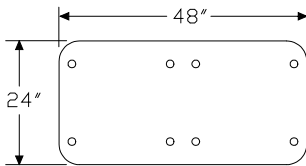

B (Double)

# Molded Plastic Armchair

DAR.  
DAW.  
DAX.

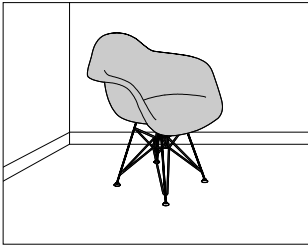

## Product Information

### Description

This chair has a single-piece shell with waterfall edges and molded back, seat and arms. Base options include a wire base, 4-leg base, or a dowel-leg base. The dowel-leg base has maple legs with non-adjustable nylon glides.

### Dimensions

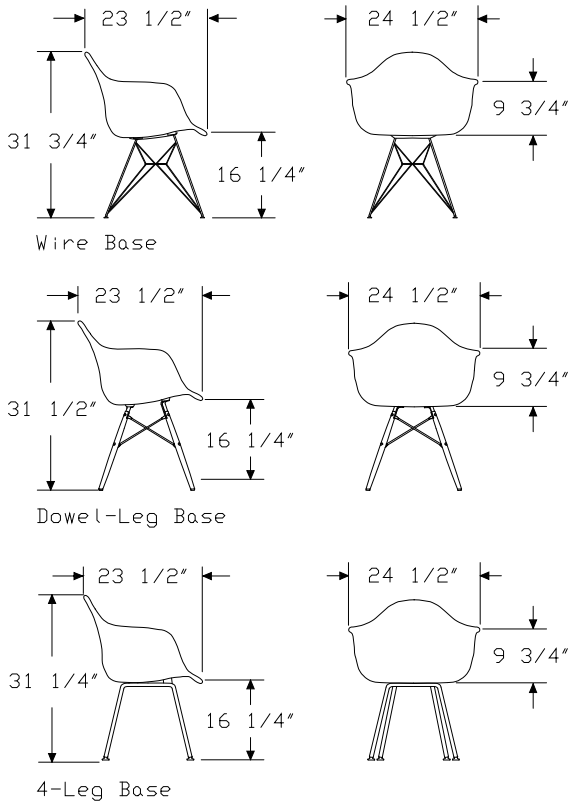

## Specification Information

### Step 1.

DA  A

### Step 2. Base Option

- R. wire base  A
- W. dowel-leg base  A
- X. 4-leg base  A

### Prices for Steps 1-2.

DAR.	\$414
DAW.	\$525
DAX.	\$343

### Step 3. Base Finish

#### For wire base (R.) or 4-leg base (X.)

CH chrome  A +\$0

#### For dowel-leg base (W.)

BU black umber  A +\$0

### Step 4. Seat/Back Finish

4T	aqua sky <input type="checkbox"/> A	+\$0
5B	java <input type="checkbox"/> A	+\$0
6Y	wafer <input type="checkbox"/> A	+\$0
92	greystone <input type="checkbox"/> A	+\$0
9J	sparrow <input type="checkbox"/> A	+\$0
ZA	black <input type="checkbox"/> A	+\$0
ZE	red <input type="checkbox"/> A	+\$0
ZF	white <input type="checkbox"/> A	+\$0
ZH	light blue <input type="checkbox"/> A	+\$0
ZS	lime green <input type="checkbox"/> A	+\$0

### Step 5. Glide Option

#### For wire base (R.) or 4-leg base (X.)

E8	standard glide <input type="checkbox"/> A	+\$0
E9	standard glide with felt bottom <input type="checkbox"/> A	+\$0

Molded Plastic Armchair with  
Rocker Base

RAR.

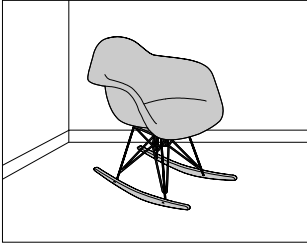

**Product Information**

**Description**

This chair has a single-piece molded seat and back with arms, waterfall edges, and chrome legs with solid-maple rockers.

**Dimensions**

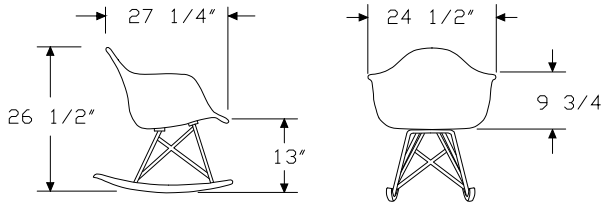

**Specification Information**

**Step 1.**

**RAR.** [A] \$597

**Step 2. Base Finish**

**CH** chrome [A] +\$0

**Step 3. Seat/Back Finish**

- 4T** aqua sky [A] +\$0
- 5B** java [A] +\$0
- 6Y** wafer [A] +\$0
- 92** greystone [A] +\$0
- 9J** sparrow [A] +\$0
- ZA** black [A] +\$0
- ZE** red [A] +\$0
- ZF** white [A] +\$0
- ZH** light blue [A] +\$0
- ZS** lime green [A] +\$0

Fame's® Classic Molded Plastic Chairs

# Wire Chair

DKR.

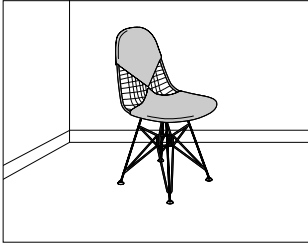

### Product Information

#### Description

This chair has a chrome seat frame and legs. It is available with a wire seat and back, a leather seat and wire back, or a leather seat and partially upholstered leather back.

#### Dimensions

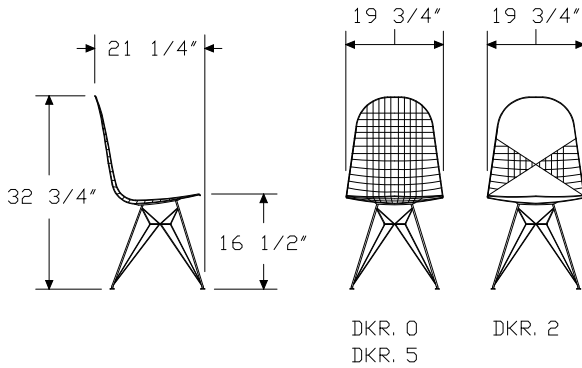

Eames® Classic Wire Chair

### Specification Information

#### Step 1.

**DKR.**  A

#### Step 2. Seat/Back Material

- 0** wire seat/wire back  A
- 2** leather seat/leather back  A
- 5** leather seat/wire back  A

#### Prices for Steps 1-2.

<b>DKR.</b>	<b>0</b>	\$800
	<b>2</b>	\$800
	<b>5</b>	\$800

#### Step 3. Seat Frame/Leg Finish

**CH** chrome  A + \$10

#### Step 4. Glide Option

- E8** standard glide  A + \$0
- E9** standard glide with felt bottom  A + \$0

#### Step 5. Leather

See textiles list for fabric usage and numbers. First 2 digits of number indicate fabric line; remaining digit(s) indicate fabric color.

	<b>2</b>	<b>5</b>
Price Category 9	+ \$995	409

Molded Chair



# Armchair

DAF

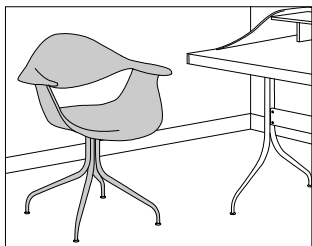

### Product Information

#### Description

This chair has a 2-piece molded seat with arms and back, waterfall edges, a cast-aluminum base with steel-tube legs, and adjustable glides.

#### Notes

Seat and back sections are permanently assembled.

Seat and back can be specified in any color combination.

#### Dimensions

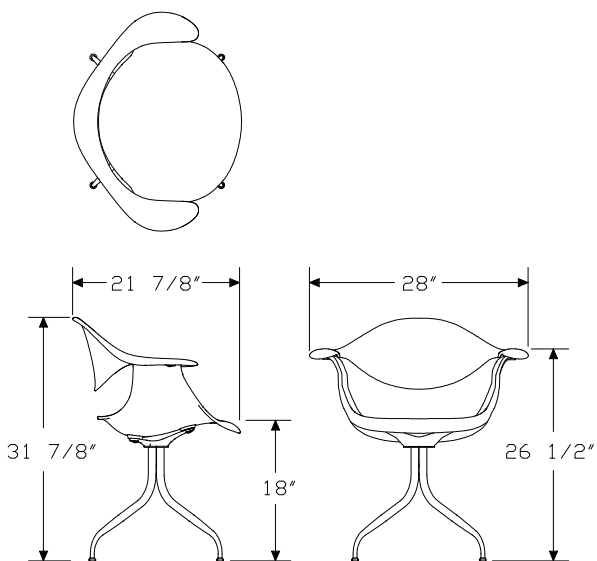

### Specification Information

#### Step 1.

**DAF**  A \$490

#### Step 2. Base Finish

**91** white  A +\$0

**BU** black umber  A +\$0

**CH** chrome  A +\$0

#### Step 3. Seat Finish

**ZA** black  A +\$0

**ZF** white  A +\$0

**ZG** grey  A +\$0

#### Step 4. Back Finish

**ZA** black  A +\$0

**ZF** white  A +\$0

**ZG** grey  A +\$0

Nelson™ Swag Leg Group Molded Chair



**Coconut Chair**

**Platform Bench**

**Marshmallow Sofa**



# Coconut Chair

5569.

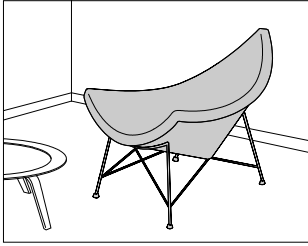

### Product Information

#### Description

This chair has a 1-piece foam cushion upholstered in black leather, a white molded plastic shell, and a polished chrome base.

#### Dimensions

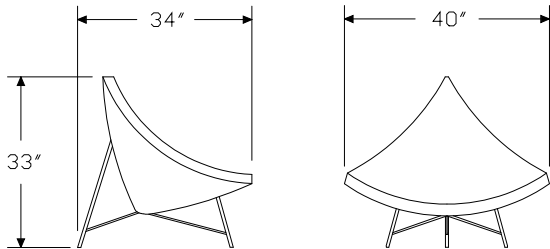

### Specification Information

#### Step 1.

5569. A

\$5103

Nelson™ Coconut Chair

Platform Bench

PB.

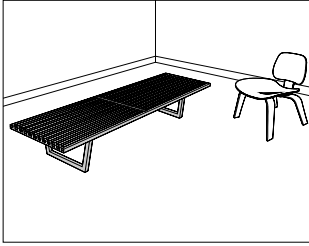

Nelson™ Platform Bench

**Product Information**

**Description**

This solid maple bench has a slatted, clear-coat maple top and an ebonized base with metal leveling glides.

**Dimensions**

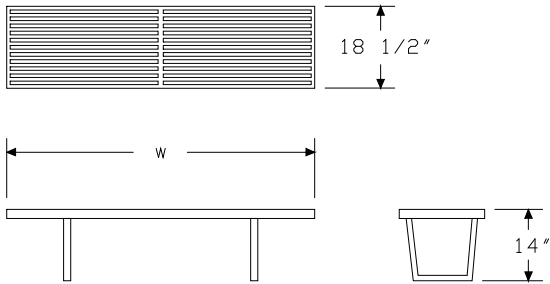

**Specification Information**

**Step 1.**

**PB.**  A

**Step 2. Width**

- 48** 48" wide  A
- 60** 60" wide  A
- 72** 72" wide  A

**Prices for Steps 1-2.**

<b>PB.</b>	<b>48</b>	\$839
	<b>60</b>	\$924
	<b>72</b>	\$1011

**Step 3. Slat Finish**

**Z5** maple  A + \$0

Marshmallow Sofa

5670

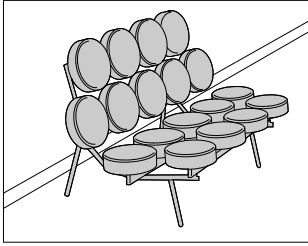

**Product Information**

**Description**

This upholstered sofa has 18 circular cushions on the back and seat, a brushed-finish tubular-steel frame, and black-satin-finish legs.

**Notes**

Customer's Own Material (COM) requires 3<sup>3</sup>/<sub>4</sub> yards. Customer's Own Leather (COL) requires 62 square feet. See Order Information in Appendices.

**Dimensions**

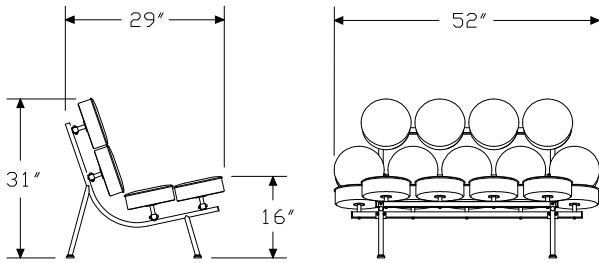

**Specification Information**

**Step 1.**

**5670** [A] \$3927

**Step 2. Fabric**

See application chart and textiles list for fabric usage and numbers. First 2 digits of number indicate fabric line; remaining digit(s) indicate fabric color.

Price Category 1	+\$0
Price Category 2	+\$0
Price Category 7	+\$1000
Price Category 9	+\$1400
Price Category R	+\$1630
Price Category V	+\$2028

Nelson™ Marshmallow Sofa







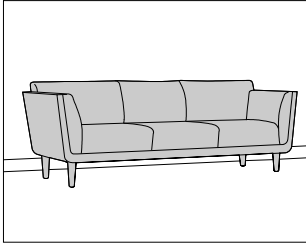

**Product Information**

**Description**

This sofa has a molded veneer frame that wraps around the sides and back. It has 7"-thick upholstered foam cushions and 4 polished cast-aluminum legs with nonadjustable nylon glides.

**Notes**

Customer's Own Material (COM) requires 10 yards. Customer's Own Leather (COL) requires 156 square feet. See Order Information in Appendices.

**Dimensions**

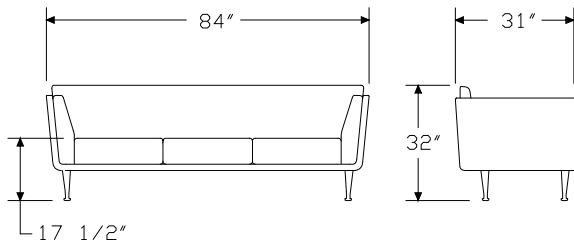

**Specification Information**

**Step 1.**

**GS100.** [A] \$4509

**Step 2. Frame Finish**

<b>AV</b>	light ash [A]	+\$0
<b>OU</b>	walnut [A]	+\$0
<b>CX</b>	natural cherry [A]	+\$50
<b>EN</b>	ebony [A]	+\$50
<b>V3</b>	cherry [A]	+\$50

**Step 3. Seat/Back Fabric**

See application chart and textiles list for fabric usage and numbers. First 2 digits of number indicate fabric line; remaining digit(s) indicate fabric color.

Price Category 1	+\$0
Price Category 2	+\$155
Price Category 3	+\$178
Price Category 4	+\$250
Price Category 7	+\$523
Price Category 9	+\$1383
Price Category B	+\$115
Price Category E	+\$287
Price Category F	+\$402
Price Category G	+\$517
Price Category H	+\$689
Price Category R	+\$1950
Price Category V	+\$3042

**Step 4. Accent Fabric**

See application chart and textiles list for fabric usage and numbers. First 2 digits of number indicate fabric line; remaining digit(s) indicate fabric color.

Price Category 1	+\$0
Price Category 2	+\$155
Price Category 3	+\$178
Price Category 4	+\$250
Price Category 7	+\$523
Price Category 9	+\$1383
Price Category B	+\$115
Price Category E	+\$287
Price Category F	+\$401
Price Category G	+\$516
Price Category H	+\$688
Price Category R	+\$1950
Price Category V	+\$3042



Stool



# Capelli Stool

KC100.

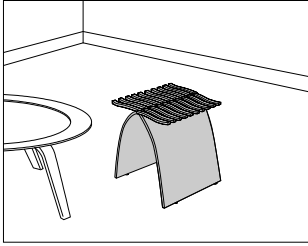

### Product Information

#### Description

This stool has 2 molded plywood pieces that interlock to form a seat. The 2 pieces lock against one another for a strong and stable structure. The stool has 11 alternating light and dark hardwood inner plies with a light ash face veneer.

#### Notes

For shipping and storage, the stool unfolds and the 2 halves stack together. No tools or fasteners are required.

#### Dimensions

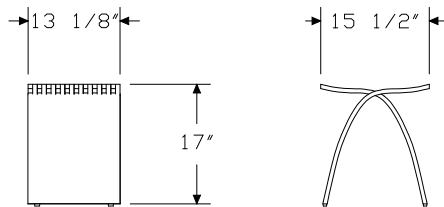

### Specification Information

#### Step 1.

**KC100.**  A \$620

#### Step 2. Finish

**AV** light ash  A +\$0

Capelli Stool



# Index by Product Name

<b>Capelli Stool</b>	
Capelli Stool	page(s) 65
<b>Eames® Aluminum Group Chairs</b>	
Executive Chair	page(s) 5
Lounge Chair	8
Management Chair	6
Ottoman	9
Side Chair	7
<b>Eames® Classic Seating</b>	
Chaise	page(s) 36
Dining Chair, Metal Legs	41
Dining Chair, Wood Legs	42
Dolly	45
Lounge	34
Lounge and Ottoman	33
Lounge Chair, Metal Legs	39
Lounge Chair, Wood Legs	40
Molded Plastic Armchair	46
Molded Plastic Armchair with Rocker Base	47
Molded Plastic Side Chair	43
Ottoman	35
Sofa	38
Sofa Compact	37
Wire Chair	48
<b>Eames® Executive Work Chair</b>	
Executive Work Chair	page(s) 21
<b>Eames® Soft Pad Group Chairs</b>	
Executive Chair	page(s) 13
Lounge Chair	16
Management Chair	14
Ottoman	17
Side Chair	15
<b>Eames® Tandem Sling Seating</b>	
Base Connector, Back to Back	page(s) 29
Tandem Sling Seating	25
<b>Goetz™ Sofa</b>	
Goetz™ Sofa	page(s) 61
<b>Nelson™ Classic Seating</b>	
Coconut Chair	page(s) 55
Marshmallow Sofa	57
Platform Bench	56
<b>Nelson™ Swag Leg Group</b>	
Armchair	page(s) 51



## Index by Product Number

473	Sofa Compact	page(s) 37
5569.	Coconut Chair	55
5670	Marshmallow Sofa	57
DAF	Armchair	51
DAR.	Molded Plastic Armchair	46
DAW.		
DAX.		
DCM.	Dining Chair, Metal Legs	41
DCW.	Dining Chair, Wood Legs	42
DKR.	Wire Chair	48
DOLLY.	Dolly	45
DSR.	Molded Plastic Side Chair	43
DSS.		
DSW.		
DSX.		
EA323	Ottoman	9
EA330	Side Chair	7
EA331		
EA333	Lounge Chair	8
EA334	Management Chair	6
EA335		
EA337	Executive Chair	5
EA338	Lounge Chair	8
EA423	Ottoman	17
EA430	Side Chair	15
EA431		
EA433	Lounge Chair	16
EA434	Management Chair	14
EA435		
EA437	Executive Chair	13
EA438	Lounge Chair	16
ES106	Chaise	36
ES108	Sofa	38
ES110		
ES204	Executive Work Chair	21
ES670	Lounge	34
ES670	Lounge and Ottoman	33
ES671	Ottoman	35
GS100.	Goetz™ Sofa	61
KC100.	Capelli Stool	65
LCM.	Lounge Chair, Metal Legs	39
LCW.	Lounge Chair, Wood Legs	40
PB.	Platform Bench	56
RAR.	Molded Plastic Armchair with Rocker Base	47
TS708	Base Connector, Back to Back	29

For more information about our products and services or to see a list of dealers, please visit us at [www.HermanMiller.com](http://www.HermanMiller.com) or call (800) 851 1196.

This book is recyclable. Printed in U.S.A. on recycled paper.

© 2010 Herman Miller, Inc., Zeeland, Michigan

© HermanMiller, , Abak, Action Office, Aeron, Ambi, Ardea, Aside, Avive, Babble, C2, Caper, Celle, Co/Struc, DOT, Eames, Embody, Equa 2, Ergon 3, Ethospace, Fine-Tune, FlexFront, Formcoat, Ground Cloth, Herman Miller for Healthcare, Herman Miller Options, Intersect, Kinemat, Leaf, Lifework, Limerick, Meridian, Mirra, Passage, Pedastool, Pellicle, Perspectives, PostureFit, Prospects, Quadrant, Reaction, Resolve, RoomTune, Scooter, Stoa, Teneo, V-Wall, Vary Easy, Vivo, and Z-Axis are among the registered trademarks of Herman Miller, Inc., and its owned subsidiaries.

™ About Face, AireWeave, Airia, Arrio, Backfit, Boomerang, Bubbletack, Burdick Group, Celeste, Cellular Suspension, CLT, CoActive, Cognita, Compass, Cygnus, Enchord, EnhancedAccess, E-Wall, Flex-Edge, Flute, Harmonic, Herman Miller for the Home, Herman Miller International Collection, Herman Miller Select, Hopsak 2, Intent, Iota, Keyless Entry, Latitude, Lyris, Multiscrim, My Studio Environments, Nelson, Pixelated Support, Programmable Environments, Q, Rapunzel, Recline Selector, Sense, Setu, Stackable, Stackable Storage, The Be Collection, Thinking is good for you, TriFlex, Tu, and Twist are among the trademarks of Herman Miller, Inc., and its owned subsidiaries.

SM TAP, Textile Alliance Program and Thoughtpile are among the service marks of Herman Miller, Inc.

Chemsurf is a registered trademark of Wilsonart International.

Corian is a registered trademark of DuPont.

FLEXNET is a trademark of Milliken & Co.

Floor Saver Glide™ is a trademark of Carpin Manufacturing Inc.

Geiger is a registered trademark of Geiger International.

Goetz is a trademark of Mark W. Goetz.

Hang-It-All is a registered trademark of Lucia Eames Demetrios, d.b.a. Eames Office.

Holophane is a registered trademark of Holophane.

Ingeo is a trademark of Cargill Dow LLC.

Microsoft and Natural Keyboard are registered trademarks of Microsoft Corporation.

Noguchi® is a registered trademark of The Isamu Noguchi Foundation and Garden Museum.

Qt Quiet technology and Qt are trademarks of Cambridge Sound Management, Inc.