

Meridian® Lateral Files

Prices effective December 7, 2009

Introduction	page 2
Meridian® Lateral Files	3
Stackable™ Lateral Files (Spec-A-File)	5
Freestanding Stackable Lateral Files (Standard Configuration)	27
Standard Pull	29
Arc Pull	33
Bevel Pull	39
Contour Pull	43
Ellipse Pull	48
Frontless	53
Sloped Pull	57
Teneo™ Pull	63
Stackable Lateral File Tops	66
Mobile Stackable Lateral Files	68
Standard Pull	68
Bevel Pull	72
Contour Pull	76
Stackable Lateral File Accessories	81
Indices	87
By Name	87
By Number	89
Appendices	
To view and/or print price book appendices, select the appropriate price book from www.HermanMiller.com .	

Introduction

A Note on the Organization of This Book

There are a few signals that will help you understand the organization of this book. Once you know them, you should be able to find your way around easily.

Like a newspaper, this book is formatted with columns of text and illustrations that run vertically.

Information wraps from one column to the next and continues for as many pages as it needs to.

Black bars are clues.

A black bar at the top of a page signals the start of information about a product.

This information is divided into two sections, each signaled by a black bar. Product Information includes a description, additional notes, and dimensional drawings. Specification Information, which always begins at the top of a column, includes a series of steps. Each step represents a decision you need to make in order to complete your product number. Steps must be followed sequentially. The number of pages needed to complete information on a product varies; some will be complete in one page; others may fill three or four pages. Just continue going through the steps until you run into the next product, signaled by the black bar at the top of the page.

Black tabs running along the outside edge of the page help you locate what section you are in or what section you want to go to. You can thumb forwards or backwards to find a section; tabs and text appear on both sides of the page.

The additional pages in the back of the book include the appendices and indices. They are signaled by a long black bar running along the outside edge of the page.

The index is presented two ways.

The first index is in alphabetical order by product name. It can be helpful if you are new to the products and numbering scheme or if you are looking for a type of product, such as work chair or round table.

The second index is by product number. It lists, in alphanumeric order, the base product number, typically a five-digit number.

General Information

This book is effective December 7, 2009, subject to change without notice. Products may be purchased from authorized Herman Miller dealers who will quote prices upon request. For more information about our products and services or to see a list of dealers, visit www.HermanMiller.com.

All prices are list prices. Additional services, such as planning services, design, storage, and installation, are not included and must be added to these prices when the additional services are requested.

Illustrations, specifications, and prices are based on the latest information at the time of publication. The right is reserved to make changes at any time without notice in prices, fabrics, finishes, materials, specifications, and models, and also to discontinue models and finishes.

Dimensions shown in the drawings are engineering drawing dimensions rounded up to the nearest $\frac{1}{8}$ ". Product is shipped set up or knocked down. Products that include "Shipped knocked down" in the description require some assembly. If this statement does not appear in the description, the product is shipped assembled.

Service problems are normally handled by a Herman Miller authorized dealer. Where this cannot be accomplished on a local level, service problems should be referred to the Customer Care Representative for your region, Herman Miller, Inc., Zeeland, Michigan 49464.

20-Day or Less/Assigned Lead-Time Shipments

All products and options in this price book not designated by an Assigned Program icon  will ship in **20 business days or less** after being acknowledged by Herman Miller.

Products and options designated by an  are on the assigned lead-time program and may ship in 20 days, less than 20 days, or more than 20 days from order acknowledgement.

Stackable™ Lateral Files (Spec-A-File)

Meridian® Stackable™ Lateral Files

Drawer Capacity & 20" Depth Filing

Drawer Capacity	Module Type	Case Depth	30" Letter	30" Legal	36" Letter	36" Legal	42" Letter	42" Legal
	Side-to-Side Filing in: C,D,N,E,G,H,L & P modules	20" or 18"	26 1/2"	26 1/2"	32 1/2"	32 1/2"	38 1/2"	38 1/2"
	Front-to-Back Filing in: N, P, E & D modules	20" 18"	35 1/2" 31 1/2"	N/A N/A	41 1/2" 37 1/2"	35 1/2" 31 1/2"	53 1/4" 47 1/4"	35 1/2" 31 1/2"

Filing Comparison

42" Wide Drawers

Side-to-Side Letter or Legal
38 1/2 Filing Inches

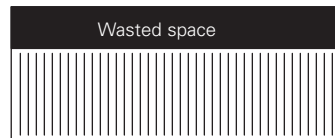

Front-to-Back Letter
53 1/4 Filing Inches



Note: 38% more filing capacity than side-to-side filing.

36" Wide Drawers

Side-to-Side Letter or Legal
32 1/2 Filing Inches

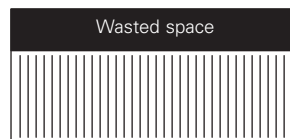

Front-to-Back Letter
41 1/2 Filing Inches



Note: 28% more filing capacity than side-to-side letter type.

Front-to-Back Legal
35 1/2 Filing Inches

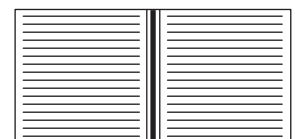

Note: 9% more filing capacity than side-to-side legal type.

30" Wide Drawers

Side-to-Side Letter or Legal
26 1/2 Filing Inches

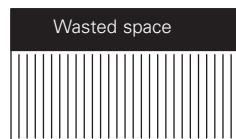

Front-to-Back Letter
35 1/2 Filing Inches

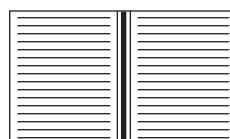

Note: 34% more filing capacity than side-to-side letter type.

Meridian® Stackable™ Lateral Files

General Information

Standard Pull (26)

Contour Pull (25)

Bevel Pull (24)

Frontless (23)

Spec-A-File

General Information

General Information

The Spec-A-File ordering procedure was designed to aid specifiers in meeting their exact filing needs. Since each component of the file (top, module, interior, base) is chosen individually, each file is a unique storage solution. The variety of top, module, and base heights available make the concern of meeting critical vertical heights a thing of the past.

Use your specification tool or the worksheet on page 8 to ensure a complete specification. Be sure to include the specification code and list price for each applicable component. A column for listing the height of each component has been included to provide a convenient means of ensuring that critical vertical dimensions are met.

Spec-A-File is comprised of the following four components. Each component must be clearly specified and priced separately.



Tops

Four heights are available ($\frac{1}{32}$ ", 1", $1\frac{1}{4}$ ", $6\frac{1}{2}$ ") in finishes of baked enamel. Laminate and veneer tops are available in $1\frac{1}{4}$ " only. Veneer tops with oversail edge are $1\frac{1}{8}$ ".

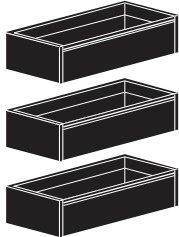

Modules

Various modules are available in heights of $11\frac{3}{4}$ ", $13\frac{1}{8}$ ", $15\frac{1}{8}$ ", $17\frac{1}{8}$ ", and $26\frac{1}{4}$ ".

Interiors

Several interior options are provided to meet your filing needs.



Bases

Five heights are available (1", $1\frac{1}{2}$ ", $2\frac{1}{4}$ ", $3\frac{1}{4}$ ", $4\frac{1}{4}$ ") in finishes of baked enamel.

Locks

Flush locks.

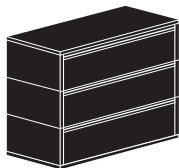

Final Assembly

Meridian will assemble all components as a complete lateral file up to 78". Files taller than 78" will be shipped as two units for final field assembly. Instructions are included.

Meridian® Stackable™ Lateral Files

Advanced Options

Spec-A-File



Add-On Modules

In order to accommodate additional filing needs, add-on modules are available for field installation to an existing lateral file. Modules do not have a base and can be ordered with or without a top. If a lock cylinder is needed, see lock appendix for ordering information. If the lock cylinder resides in the existing file, the add-on modules will need to be specified with lockbars.

Example: 26-3618-ADDON

Lock Option: LB-Lockbars, to attach to an existing unit



Reversed Modules

Reversed file drawers allow one stack of lateral file modules to service two users—conserving floor space. For safety reasons, only one direction reversal is allowed per file. The number of modules facing each direction is not limited.

Drawers are reversed in the field by utilizing a stile lock hardware kit for additional lock and a reversing conversion kit for additional inter-lock pieces. Kit number: U1B3P7F

Factory-reversed units need to be ordered through Herman Miller Options.

Advanced Options

The flexibility and modularity of the stackable lateral file modules allow a specifier to create an infinite number of storage solutions.

To further enhance the uniqueness of the file, use one of the following advanced options available in Advanced Spec-A-File:

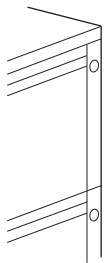

Multiple Locks – Standard Pull

Since the lock is housed in the module frame of standard pull lateral files, locks can be strategically placed to accommodate multiple users in one filing unit. In the case of keyed alike, identified modules will have factory-installed lockbars and lock hole knocked out to allow for field installation of lock cylinder. If additional security is required between drawers, specify security pans between modules.

Existing files can be retrofitted with multiple locks by requesting a stile lock hardware kit from your Customer Care representative.

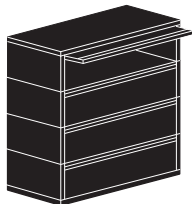

Combination Lateral File

It is considered to be a combination lateral file when combining standard pull with bevel or contour pull lateral file drawers. To specify a combination unit, choose a bevel or contour pull lateral file in Advanced Spec-A-File. The standard pull modules will be listed on the module choices, signified by the following note (2600 Series).

Multiple Paints

Multiple paints are available on a single unit by specifying one of the following options:

- F: Different case and front finishes
- M: Different top, module, and base finishes
- N: Unit all one color

**Note: Copy
This Form
Before Using**

Meridian® Stackable™ Lateral Files Worksheet

Standard Pull (26), Contour Pull (25), Bevel Pull (24), Frontless (23)

Spec-A-File

Description	Pull Style	Width	Depth	Number of Modules	Spec Code	Item List Price	Item Height
Item Number:							
Steel Finish:	TS Textured Steel or SS Smooth Steel or XS Textured paint on smooth steel						
Paint Color:	(Refer to Meridian Color Palette. Enter Numerical Code Only.)						
Metallic Paint Upcharge:	\$65						\$
Contour Pull Finish:	(Refer to Meridian Color Palette. Enter Numerical Code for paint or wood.)						
Geiger® Contour Pull Finish:	\$15 [A]						\$
Top:	NT, T1, T2, T3, T6, T7, TL, TF [A], TR [A], TA, TV1 [A] or J3 [A]						\$ In.
Dome Top:	D1, H1 or H2						\$ In.
Cushion Top:	TC1 or TC2						\$ In.
Cushion Top Fabric: <i>Category 2-8 and A-K Upcharge</i>	If Applicable						\$
Laminate Top Color:	If Applicable (Refer to Meridian Color Palette. Enter Numerical Code Only.)						
Vinyl Edge Color:	If Applicable						
Veneer Finish:	If Applicable [A]						
Geiger Wood Veneer Top:	\$35 [A]						\$ In.
Module 1: (From The Top)	N, E, F, C, D, J, K, P, G, L, H, S, A, B, OS, OH, OB, OI or OM						\$ In.
Interior 1:	9P, 9Q, 9C-LT, 9C-LG, 9W-LT, 9W-LG, 9T, 9M, 9R, 9V, 9X or 9Y						\$
Module 2: (From The Top)	N, E, F, C, D, J, K, P, G, L, H, S, A or B						\$ In.
Interior 2:	9P, 9Q, 9C-LT, 9C-LG, 9W-LT, 9W-LG, 9T, 9M, 9R, 9V, 9X or 9Y						\$
Module 3: (From The Top)	N, E, F, C, D, J, K, P, G, L, H, S, A or B						\$ In.
Interior 3:	9P, 9Q, 9C-LT, 9C-LG, 9W-LT, 9W-LG, 9T, 9M, 9R, 9V, 9X or 9Y						\$
Module 4: (From The Top)	N, E, F, C, D, J, K, P, G, L, H, S, A or B						\$ In.
Interior 4:	9P, 9Q, 9C-LT, 9C-LG, 9W-LT, 9W-LG, 9T, 9M, 9R, 9V, 9X or 9Y						\$
Module 5: (From The Top)	N, E, F, C, D, J, K, P, G, L, H, S, A or B						\$ In.
Interior 5:	9P, 9Q, 9C-LT, 9C-LG, 9W-LT, 9W-LG, 9T, 9M, 9R, 9V, 9X or 9Y						\$
Module 6: (From The Top)	N, E, F, C, D, J, K, P, G, L, H, S, A or B						\$ In.
Interior 6:	9P, 9Q, 9C-LT, 9C-LG, 9W-LT, 9W-LG, 9T, 9M, 9R, 9V, 9X or 9Y						\$
Module 7: (From The Top)	N, E, F, C, D, J, K, P, G, L, H, S, A or B						\$ In.
Interior 7:	9P, 9Q, 9C-LT, 9C-LG, 9W-LT, 9W-LG, 9T, 9M, 9R, 9V, 9X or 9Y						\$
Base:	B1, B2, B3, B4, B5, BA, BB, BC or BD						\$ In.
Lock:	KD: Keyed Differently, Black Lock KC: Keyed Differently, Chrome Lock KA: Keyed Alike, Black Lock KQ: Keyed Alike, Chrome Lock						
Counter Balance Weight:	CB						\$
Total List Price:	Add All Prices Above For Total List Price						\$
Total Assembled Height:	Check Total Height By Adding All Heights Listed Above						In.







Meridian® Stackable™ Lateral File Tops

Standard Pull (26)

Contour Pull (25)

Bevel Pull (24)

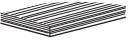
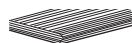
Spec-A-File

Tops	Description	Spec Code	H	D	W	LIST PRICE
No Top		NT				N/C
 Square Edge Metal Top	Metal top with square edge. Baked enamel finish.	T1	1"	20" or 18"	30"	\$ 54.
					36"	\$ 67.
					42"	\$ 82.
		T2	1 1/4"	20" or 18"	30"	\$ 54.
					36"	\$ 67.
					42"	\$ 82.
 Radius Edge Metal Top	Metal top with radius edge front and back. Baked enamel finish.	T3	1 1/4"	20" or 18"	30"	\$ 109.
					36"	\$ 122.
					42"	\$ 137.
 Laminate Top with Vinyl Edge*	Laminate top with vinyl edge.	TL	1 1/4"	20" or 18"	30"	\$ 117.
					36"	\$ 130.
					42"	\$ 145.
 Cathedral Recut Veneer Top	Cathedral recut veneer top with 3mm edge banding.	J3 A	1 1/4"	20" or 18"	30"	\$ 189.
					36"	\$ 202.
					42"	\$ 217.
 Wood Veneer Top	Wood veneer top with 3mm edge banding.	TF A	1 1/4"	20" or 18"	30"	\$ 191.
					36"	\$ 204.
					42"	\$ 219.
 Recut Veneer Top	Recut veneer top with 3mm edge banding.	TR A	1 1/4"	20" or 18"	30"	\$ 186.
					36"	\$ 199.
					42"	\$ 214.
 Wood Veneer Top with Oversail Front Edge*	Wood veneer top and wood composite edge with oversail front.	TV1 A	1 1/8"	20" or 18"	30"	\$ 338.
					36"	\$ 351.
					42"	\$ 366.
 Security Top	Flat steel cover with baked enamel finish. Designed to protect contents and minimize overall height; not to be used for support or as an exposed top. Available on N, E and H modules and Overhead Storage Units only.	T6	1/32"	20" or 18"	30"	\$ 54.
					36"	\$ 67.
					42"	\$ 82.
 Planter Top*	Steel shell with baked enamel finish. Includes black plastic tub liner. Cannot house a lock.	T7	6 1/2"	20" or 18"	30"	\$ 231.
					36"	\$ 244.
					42"	\$ 259.

* **Note:** When ordering a radius edge laminate top, laminate top with vinyl edge banding, planter top with a contour pull or bevel pull product, or a veneer top with oversail edge, an additional top is required if the file is to include a lock. Call Customer Service for details.

Meridian® Stackable™ Lateral File Dome Tops



Standard Pull (26)

Contour Pull (25)

Bevel Pull (24)

Frontless (23)

Spec-A-File

Tops	Description	Spec Code	H	D	W	LIST PRICE
Full Dome Top 	6 1/2" high metal top with full dome side-to-side. Baked enamel finish.	D1	6 1/2"	18" or 20"	30"	\$ 296.
					36"	\$ 309.
					42"	\$ 324.
Half Dome Top 	6 1/2" high metal top with half dome sloping left. Baked enamel finish.	H1	6 1/2"	18" or 20"	30"	\$ 296.
					36"	\$ 309.
					42"	\$ 324.
	6 1/2" high metal top with half dome sloping right. Baked enamel finish.	H2	6 1/2"	18" or 20"	30"	\$ 296.
					36"	\$ 309.
					42"	\$ 324.

Note: When specifying a half dome or full dome top with bevel or contour pull lateral files, a lock option is not available.

Meridian® Stackable™ Lateral File Cushion Tops/Cushion Fabrics

Standard Pull (26)

Contour Pull (25)

Bevel Pull (24)

Spec-A-File

Tops	Description	Spec Code	H	D	W	LIST PRICE
	Cushion top available 1" or 2" high, provides temporary guest seating. Attaches with velcro strips to T1 or T2 metal top.	TC1	1"	18" or 20"	30"	\$ 350.
		TC2	2"		36"	\$ 350.
					42"	\$ 350.

Tops	Description	Spec Code	Fabric Category	UPCHARGE
	<p>Cushion available in Herman Miller seating fabric.</p> <p>Fabric requirements: Customer's Own Material (COM) requires yardage listed below.</p>	See textile appendices for fabric families and color codes.	Price Category 1	N/C
			Price Category 2	\$ 55.
			Price Category 3	\$ 67.
			Price Category 4	\$ 82.
			Price Category 5	\$ 99.
			Price Category 6	\$ 118.
			Price Category 7	\$ 137.
			Price Category 8	\$ 175.
			Price Category B	\$ 56.
			Price Category E	\$ 139.
			Price Category G	\$ 250.
			Price Category H	\$ 333.

Width of Cushion	Yards of Fabric
30"	1.05
36"	1.22
42"	1.40

When ordering more than one cushion, please round up the total yardage requirement to the next full yard of fabric.

Meridian® Stackable™ Lateral File Overhead Storage Units



Standard Pull (26)

Contour Pull (25)

Bevel Pull (24)

Spec-A-File

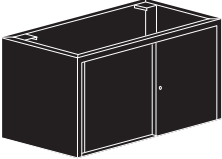
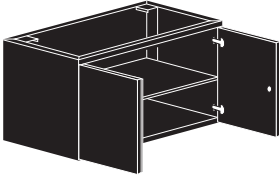
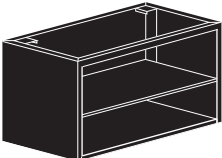

Description		Spec Code	H	D	W	Standard Pull (26)	Contour Pull (25)	Bevel Pull (24)							
26 1/4" High															
LIST PRICE															
OS 	Overhead Storage*. Cabinet with locking sliding doors. Includes one adjustable shelf. (KA and KQ) lock options not available. Interior depth: 18" (20") and 16" (18"). Interior height: 24 1/4".	OS	26 1/4"	20"	30"	\$ 475.	N/A	N/A							
						36"	\$ 541.	N/A	N/A						
						42"	\$ 609.	N/A	N/A						
						18"	30"	\$ 475.	N/A	N/A					
							36"	\$ 541.	N/A	N/A					
							42"	\$ 609.	N/A	N/A					
						OH 	Overhead Storage*. Cabinet with locking hinged doors. Includes one adjustable shelf. Interior depth: 18" (20") and 16" (18"). Interior height: 24 1/4".	OH	26 1/4"	20"	30"	\$ 516.	\$ 606.	\$ 516.	
												36"	\$ 581.	\$ 668.	\$ 581.
												42"	\$ 650.	\$ 733.	\$ 650.
18"	30"	\$ 516.	\$ 606.	\$ 516.											
	36"	\$ 581.	\$ 668.	\$ 581.											
	42"	\$ 650.	\$ 733.	\$ 650.											
OB 	Overhead Storage*. Cabinet without doors. Includes one adjustable shelf. Interior depth: 18" (20") and 16" (18"). Interior height: 24 1/4".	OB	26 1/4"	20"	30"							\$ 436.	N/A	N/A	
												36"	\$ 504.	N/A	N/A
												42"	\$ 570.	N/A	N/A
						18"	30"	\$ 436.	N/A	N/A					
							36"	\$ 504.	N/A	N/A					
							42"	\$ 570.	N/A	N/A					
						<p>Note: * When ordering an overhead storage with a contour pull or bevel pull lateral file, an additional top is required if the file drawers are to lock. Call Customer Service for details.</p> <p>* Application Notes: Other modules can be placed on top of an overhead storage unit only if they have a fixed shelf.</p> <p>Pull out shelves may not be used above an overhead storage unit.</p>									
						Interiors									
						Description		Spec Code			D	W	LIST PRICE		
NS 	Adjustable steel shelf with matching baked enamel finish.	NS			20" or 18"	30"	\$ 38.								
						36"	\$ 46.								
						42"	\$ 54.								

Meridian® Stackable™ Lateral File Overhead Storage Units – Multi-User Standard Pull (26)

Spec-A-File

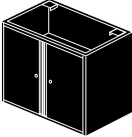
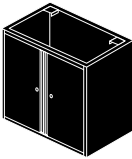

Tops	Description	Spec Code	H	D	W	Standard Pull (26)	LIST PRICE
OI 	23 ¹ / ₂ " partitioned overhead storage unit with two individually locking hinged doors and one adjustable shelf per opening. Interior depth: 18" (20") and 16" (18"). Interior height: 21 ¹ / ₂ ".	OI	23 ¹ / ₂ "	20"	30"		\$ 798.
					36"		\$ 862.
					42"		\$ 923.
					18"	30"	\$ 798.
					36"	\$ 862.	
					42"	\$ 923.	
OM 	26 ¹ / ₄ " partitioned overhead storage unit with two individually locking hinged doors and one adjustable shelf per opening. Interior depth: 18" (20") and 16" (18"). Interior height: 24 ¹ / ₄ ".	OM	26 ¹ / ₄ "	20"	30"		\$ 824.
					36"		\$ 887.
					42"		\$ 949.
					18"	30"	\$ 824.
					36"	\$ 887.	
					42"	\$ 949.	

The OI and OM overhead storage units can be used in conjunction with individually locking standard pull drawer modules to create multi-user storage and filing units. Security pans between drawers are available. Modules can also be reversed. The following examples can be used as guidelines, or contact your Customer Care representative for more details on reversed module stack combinations.

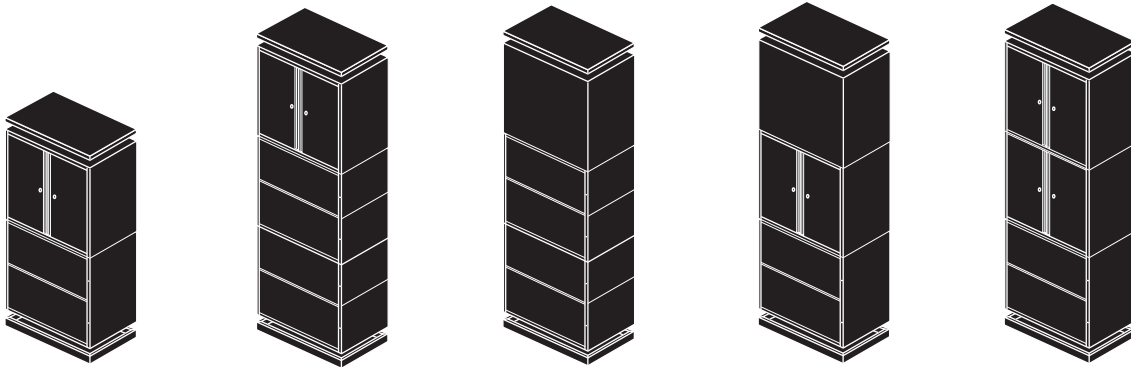

Additional Storage Shelf	Description	Spec Code	Cabinet	D	W	LIST PRICE
	Adjustable steel shelf with baked enamel finish. 15" fits one opening of 30" wide partitioned cabinet. 18" fits one opening of 36" wide partitioned cabinet. 21" fits one opening of 42" wide partitioned cabinet.	SSF-15				\$ 49.
		SSF-18				\$ 55.
		SSF-21				\$ 59.

Meridian® Stackable™ Lateral File Modules

Standard Pull (26)

Contour Pull (25)

Bevel Pull (24)

Spec-A-File

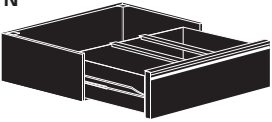
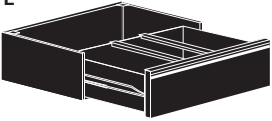
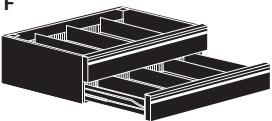
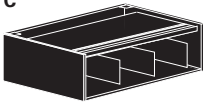
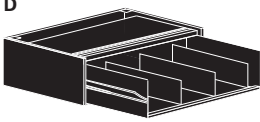

Modules	Description	Spec Code	H	D	W	Standard Pull (26)	Contour Pull (25)	Bevel Pull (24)
LIST PRICE								
11³/₄" High								
	File drawer / fixed front. Standard 9P interior: hanging folder rails for front-to-back filing. Optional interiors: 9M, 9R, 9W-LT, 9W-LG, 9C-LT, 9C-LG. Interior depth: 17 ³ / ₄ " (20") or 15 ³ / ₄ " (18"). Interior height: 10 ⁵ / ₈ ". Hanging clearance: 9 ⁷ / ₁₆ " for 9P, 9R, 9C-LG, 9C-LT.	N	11 ³ / ₄ "	20" or 18"	30"	\$ 281.	\$ 349.	\$ 281.
					36"	\$ 306.	\$ 386.	\$ 306.
					42"	\$ 345.	\$ 442.	\$ 345.
13¹/₈" High								
	File drawer / fixed front. Standard 9P interior: hanging folder rails for front-to-back filing. Optional interiors: 9M, 9R, 9W-LT, 9W-LG, 9C-LT, 9C-LG. Interior depth: 17 ³ / ₄ " (20") or 15 ³ / ₄ " (18"). Interior height: 12". Hanging clearance: 9 ⁷ / ₁₆ " for 9P, 9R, 9C-LG, 9C-LT.	E	13 ¹ / ₈ "	20" or 18"	30"	\$ 281.	\$ 349.	\$ 281.
					36"	\$ 306.	\$ 386.	\$ 306.
					42"	\$ 345.	\$ 442.	\$ 345.
	Two half height drawers with fixed fronts. Standard 9T interior: 3 adjustable partitions per half drawer for index card filing. Interior depth: 17 ³ / ₄ " (20") or 15 ³ / ₄ " (18"). Interior height: 5 ³ / ₈ ".	F	13 ¹ / ₈ "	20" or 18"	30"	\$ 543.	\$ 685.	\$ 543.
					36"	\$ 569.	\$ 735.	\$ 569.
					42"	\$ 607.	\$ 800.	\$ 607.
	Fixed shelf / flip door. Standard 9M interior: 3 movable dividers for side-to-side paper folder filing. Optional interiors: 9V. Interior depth: 17 ³ / ₄ " (20") or 15 ³ / ₄ " (18"). Interior height: 10 ¹ / ₄ ".	C	13 ¹ / ₈ "	20" or 18"	30"	\$ 284.	N/A	N/A
					36"	\$ 312.	N/A	N/A
					42"	\$ 352.	N/A	N/A
	Pull-out shelf / flip door. Standard 9M interior: 3 movable dividers for side-to-side paper folder filing. Optional interiors: 9Q, 9R, 9V, 9W-LT, 9W-LG, 9C-LT, 9C-LG. Interior depth: 17 ³ / ₄ " (20") or 15 ³ / ₄ " (18"). Interior height: 10 ¹ / ₄ ". Hanging clearance: 9 ⁷ / ₁₆ " for 9P, 9R, 9C-LG, 9C-LT.	D	13 ¹ / ₈ "	20" or 18"	30"	\$ 319.	N/A	N/A
					36"	\$ 345.	N/A	N/A
					42"	\$ 383.	N/A	N/A

Meridian® Stackable™ Lateral File Modules – *Continued*



Standard Pull (26)

Contour Pull (25)

Bevel Pull (24)

Spec-A-File

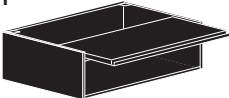

Modules	Description	Spec Code	H	D	W	Standard Pull (26)	Contour Pull (25)	Bevel Pull (24)
LIST PRICE								
13¹/₈" High								
J 	Open module with full back accommodates binders up to 11 ³ / ₄ " tall. Interior depth 17 ¹ / ₂ " or 19 ¹ / ₂ ". Interior height: 11 ⁷ / ₈ ". Accommodates 9Y interiors (sold separately).	J	13¹/₈"	20" or 18"	30"	\$ 355.	N/A	N/A
					36"	\$ 376.	N/A	N/A
					42"	\$ 399.	N/A	N/A
					Note: Cannot be used as the bottom module if a counterbalance is specified.			
Note: Security top cannot be attached to a "J" module.								
K 	Pass through unit. Interior depth: 19 ³ / ₄ " (20") or 17 ³ / ₄ " (18"). Interior height: 11 ⁷ / ₈ ".	K	13¹/₈"	20" or 18"	30"	\$ 290.	N/A	N/A
					36"	\$ 312.	N/A	N/A
					42"	\$ 354.	N/A	N/A
					Note: Not field installable.			
P 	Combination posting shelf and 11 ³ / ₄ " fixed front file pullout drawer. Standard 9P interior: hanging folder rails for front-to-back filing. Optional interiors: 9M, 9R, 9W-LT, 9W-LG, 9C-LT, 9C-LG. Interior depth: 17 ³ / ₄ " (20") or 15 ³ / ₄ " (18"). Interior height: 10 ⁵ / ₈ ". Hanging clearance: 9 ⁷ / ₁₆ " for 9P, 9R, 9C-LG, 9C-LT.	P	13¹/₈"	20" or 18"	30"	\$ 395.	N/A	N/A
					36"	\$ 422.	N/A	N/A
					42"	\$ 459.	N/A	N/A

Meridian® Stackable™ Lateral File Modules – *Continued*



Standard Pull (26)

Contour Pull (25)

Bevel Pull (24)

Spec-A-File

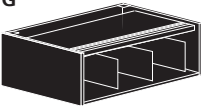
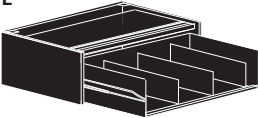
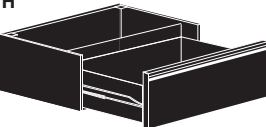

Modules	Description	Spec Code	H	D	W	Standard Pull (26)	Contour Pull (25)	Bevel Pull (24)	
						LIST PRICE			
15 1/8" High									
G 	Fixed shelf / flip door. Standard 9M interior: 3 movable dividers for large folders and binder storage. Optional interiors: 9V. Interior depth: 17 3/4" (20") or 15 3/4" (18"). Interior height: 12 1/4". Note: Drawer front does not completely recede on 18" deep modules.	G	15 1/8"	20" or 18"	30"	\$ 404.	N/A	N/A	
						36"	\$ 435.	N/A	N/A
						42"	\$ 470.	N/A	N/A
L 	Pullout shelf / flip door. Standard 9M interior: 3 movable dividers for large folders and binder storage. Optional interiors: 9V, 9W-LT, 9W-LG, 9X, 9Q. Interior depth: 17 3/4" (20") or 15 3/4" (18"). Interior height: 12 1/4". Hanging clearance: 9 9/16" for 9V, 11 9/16" for 9X.	L	15 1/8"	20" or 18"	30"	\$ 446.	N/A	N/A	
						36"	\$ 470.	N/A	N/A
						42"	\$ 512.	N/A	N/A
H 	File drawer / fixed front. Standard 9X interior: 2 rails for computer printout hanging binders and folders. Optional interiors: 9M, 9W-LT, 9W-LG, 9Q. To accommodate letter-width computer printout hanging binders, contact Meridian. Interior depth: 17 3/4" (20") or 15 3/4" (18"). Interior height: 14". Hanging clearance: 11 9/16" for 9X.	H	15 1/8"	20" or 18"	30"	\$ 370.	\$ 458.	\$ 370.	
						36"	\$ 392.	\$ 499.	\$ 392.
						42"	\$ 430.	\$ 552.	\$ 430.
S 	Fixed shelf / locking sliding doors. Ideal for binder storage. Interior depth: 18" (20") or 16" (18"). Interior height: 13 1/8". (KA and KQ) lock options not available.	S	15 1/8"	20" or 18"	30"	\$ 359.	N/A	N/A	
						36"	\$ 385.	N/A	N/A
						42"	\$ 427.	N/A	N/A

Meridian® Stackable™ Lateral File Modules – *Continued*

Standard Pull (26)

Contour Pull (25)

Bevel Pull (24)

Spec-A-File



Modules	Description	Spec Code	H	D	W	Standard Pull (26)	Contour Pull (25)	Bevel Pull (24)
---------	-------------	-----------	---	---	---	--------------------	-------------------	-----------------

17¹/₈" High

LIST PRICE

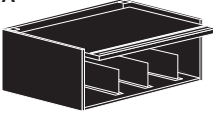
A 	Fixed shelf / flip door. Standard 9Y interior: 3 movable magnetic dividers for large binder storage. Interior depth: 19" (20") or 17" (18"). Interior height: 14 ¹ / ₂ ".	A	17 ¹ / ₈ "	20" or 18"	30"	\$ 452.	N/A	N/A
					36"	\$ 478.	N/A	N/A
					42"	\$ 518.	N/A	N/A
					Note: Drawer front does not completely recede.			

B 	Two half-height drawers / fixed fronts. Standard 9T interior: 3 adjustable partitions per half drawer. Interior depth: 17 ³ / ₄ " (20") or 15 ³ / ₄ " (18"). Interior height: 7 ³ / ₈ ".	B	17 ¹ / ₈ "	20" or 18"	30"	\$ 607.	N/A	N/A
					36"	\$ 633.	N/A	N/A
					42"	\$ 674.	N/A	N/A

CD Storage*

Drawer Size	Number of CDs per Row	Number of Complete Rows per Half Drawer
30" x 18"	40	4
30" x 20"	44	4
36" x 18"	40	5
36" x 20"	44	5
42" x 18"	40	6
42" x 20"	44	6



*Calculation based on average CD size of 5⁵/₈" x 4⁷/₈" x 3³/₈".

VHS Storage**

Drawer Size	Number of VHS Tapes per Row	Number of Complete Rows per Half Drawer
30" x 18"	12	3
30" x 20"	14	3
36" x 18"	12	4
36" x 20"	14	4
42" x 18"	12	4
42" x 20"	14	4



**Calculation based on average VHS case size of 8" x 4³/₄" x 1¹/₄".

Meridian® Stackable™ Lateral Files











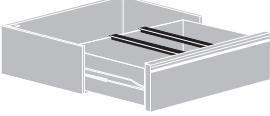

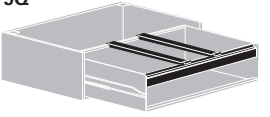

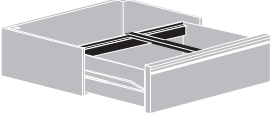
Interiors/Bases/Options

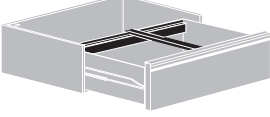
Standard Pull (26)

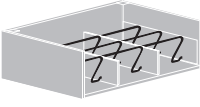
Contour Pull (25)

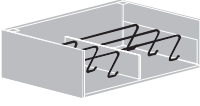
Bevel Pull (24)

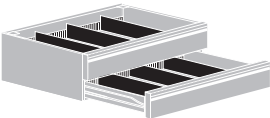
Spec-A-File

Interiors	Description	Filing Devices	Spec Code													
Front-To-Back Filing				U P C H A R G E												
9P 	Front-to-back filing rails for hanging file folders. Standard in modules: E, N, P.	 Hanging File Folder	9P	N/C												
9Q 	Front-to-back filing rails for hanging file folders. For use in flip door units. Optional in D, L and H modules.	 Hanging File Folder	9Q	N/C												
9C-LG 	Combination front-to-back and side-to-side rails for filing one row side-to-side legal and one row front-to-back letter of hanging file folders. Optional in modules E, N, D, P.	 Hanging File Folder	9C-LG	N/C												
9C-LT 	Combination front-to-back and side-to-side rails for filing one row side-to-side letter and one row front-to-back legal of hanging file folders. Optional in modules E, N, D, P.	 Hanging File Folder	9C-LT	N/C												
9W-LT 	Wobble dividers for filing letter size paper folders front-to-back. Optional in modules N, E, D, P, L, H.	 File Folder	9W-LT	<table border="1"> <tr> <td>30" wide</td> <td style="text-align: right;">\$ 45.</td> </tr> <tr> <td>36" wide</td> <td style="text-align: right;">\$ 45.</td> </tr> <tr> <td>42" wide</td> <td style="text-align: right;">\$ 51.</td> </tr> </table>	30" wide	\$ 45.	36" wide	\$ 45.	42" wide	\$ 51.						
30" wide	\$ 45.															
36" wide	\$ 45.															
42" wide	\$ 51.															
	<p>Letter</p> <table border="1"> <thead> <tr> <th>File Width</th> <th>9M Dividers</th> <th>Letter Width Wobbles</th> </tr> </thead> <tbody> <tr> <td>30"</td> <td>4</td> <td>6</td> </tr> <tr> <td>36"</td> <td>4</td> <td>6</td> </tr> <tr> <td>42"</td> <td>6</td> <td>9</td> </tr> </tbody> </table>	File Width	9M Dividers	Letter Width Wobbles	30"	4	6	36"	4	6	42"	6	9	 Expandable Pocket Folder		
File Width	9M Dividers	Letter Width Wobbles														
30"	4	6														
36"	4	6														
42"	6	9														
9W-LG 	Wobble dividers for filing legal size paper folders front-to-back. Optional in modules N, E, D, P, L, H.	 File Folder	9W-LG	<table border="1"> <tr> <td>30" wide</td> <td style="text-align: right;">\$ 45.</td> </tr> <tr> <td>36" wide</td> <td style="text-align: right;">\$ 51.</td> </tr> <tr> <td>42" wide</td> <td style="text-align: right;">\$ 51.</td> </tr> </table>	30" wide	\$ 45.	36" wide	\$ 51.	42" wide	\$ 51.						
30" wide	\$ 45.															
36" wide	\$ 51.															
42" wide	\$ 51.															
	<p>Legal</p> <table border="1"> <thead> <tr> <th>File Width</th> <th>9M Dividers</th> <th>Legal Width Wobbles</th> </tr> </thead> <tbody> <tr> <td>30"</td> <td>2</td> <td>3</td> </tr> <tr> <td>36"</td> <td>4</td> <td>6</td> </tr> <tr> <td>42"</td> <td>4</td> <td>6</td> </tr> </tbody> </table>	File Width	9M Dividers	Legal Width Wobbles	30"	2	3	36"	4	6	42"	4	6			
File Width	9M Dividers	Legal Width Wobbles														
30"	2	3														
36"	4	6														
42"	4	6														
9T 	Set of six movable partitions, 3 per half-height drawer. Standard in modules F and B only.		9T	N/C												
9Y 	Three movable magnetic dividers for large binder storage. Side-to-Side Filing only. 12"H X 5"W X 16"D Standard in A module only.		9Y	N/C												

Meridian® Stackable™ Lateral Files











Interiors/Bases/Options – *Continued*



Standard Pull (26)

Contour Pull (25)

Bevel Pull (24)

Spec-A-File

Interiors	Description	Filing Devices	Spec Code	
Side-To-Side Filing U P C H A R G E				
9M 	Three movable dividers for filing paper folders. Standard in modules: C, D, G, L. Optional in modules: E, N, H, P.	 File Folder  Binder  Expandable Pocket Folder	9M	N/C
9R 	Side-to-side rails for hanging file folders (letter, legal, A-4, foolscap). Optional in modules: E, N, D, H, P. 1 required for E, N, and P modules. 2 required for D and H modules.	 Hanging File Folder	9R	N/C
9V 	Movable dividers (9M) with side-to-side rail (9R) for tab style side-to-side filing. Optional in modules: C, D, G, L.	 File Folder	9V	N/C
9X 	Side-to-side filing rails for computer printout hanging binders and folders, 2 rails included. Standard in H module. Optional in L module.	 Standard Hanging Computer Paper Folder	9X	N/C

Bases / Options	Description	Spec Code	H	D	W	LIST PRICE	
Bases 	Frame-type steel base with baked enamel finish. Includes four adjustable leveling glides.	B1	1"	20" or 18"	30"	\$ 68.	
		B2	1 1/2"		36"	\$ 83.	
		B3	2 1/4"		42"	\$ 95.	
		B4	3 1/4"				
		B5	4 1/4"	20" or 18"	30"	\$ 100.	
Recessed Bases 	Frame-type steel base with baked enamel finish. Recessed 1 1/16". Includes four adjustable leveling glides.	BA	1"	20" or 18"	30"	\$ 100.	
		BB	1 1/2"		36"	\$ 115.	
		BC	2 1/4"		42"	\$ 127.	
		BD	3 1/4"				
Lock	Flush lock. Locks are located in the module frame in the standard pull lateral file. Locks are located in the top in the bevel pull and contour pull lateral files.	KD, KC, KA or KQ				\$ 32.	
Counterbalance Weight	Recommended for 2 and 3-high lateral files.	CB				\$ 120.	
Security Pan 	Flat steel pan placed between modules of a lateral file stack. For use on B, C, D, E, F, G, H, L, N, P modules.	PN	1/32"	20" or 18"	30"	\$ 37.	
					36"	\$ 43.	
					42"	\$ 51.	

Note: List price upcharge is for quantity 1 security pan.

Meridian® Stackable™ Lateral Files

General Information and Specifications

Frontless (23)

Spec-A-File

General Information

General Information

Frontless Stackable Lateral Files have been designed to provide specifiers with the ability to offer aesthetic alternatives in the office environment. The guide below includes a template for drawer front fabrication.

Custom-Fabricated Drawer Fronts

Fabrication Information

Custom fronts can be fabricated from a variety of materials. Choose the one that best complements your office interior. Drawer pulls are an integral part of the drawer front design. Keep in mind the usage patterns of the file users and the placement of the files when choosing a pull.

For additional information regarding applications and usages of frontless files, consult your local Herman Miller authorized dealer or Customer Care Representative for your region.

A template has been included to aid in the design of your custom front. Complete dimension information allows for an easier installation.

Lateral Drawer Front Dimensions

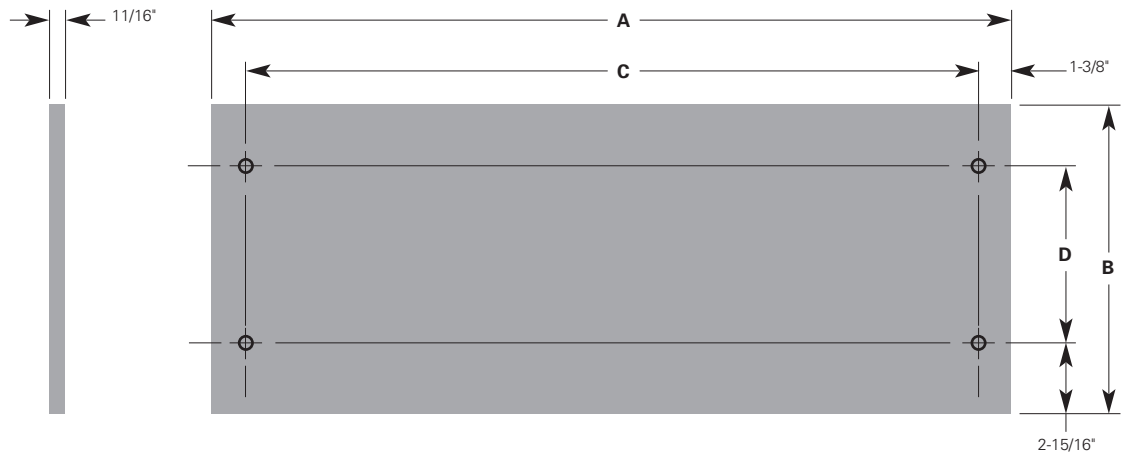

W I D T H









Module	Nominal	Actual	A	B	C	D
N	30"	29 ⁷ / ₈ "	29 ³ / ₄ "	11 ⁵ / ₈ "	27"	6 ¹ / ₂ "
N	36"	35 ⁷ / ₈ "	35 ³ / ₄ "	11 ⁵ / ₈ "	33"	6 ¹ / ₂ "
N	42"	41 ⁷ / ₈ "	41 ³ / ₄ "	11 ⁵ / ₈ "	39"	6 ¹ / ₂ "
E	30"	29 ⁷ / ₈ "	29 ³ / ₄ "	12 ¹⁵ / ₁₆ "	27"	6 ¹ / ₂ "
E	36"	35 ⁷ / ₈ "	35 ³ / ₄ "	12 ¹⁵ / ₁₆ "	33"	6 ¹ / ₂ "
E	42"	41 ⁷ / ₈ "	41 ³ / ₄ "	12 ¹⁵ / ₁₆ "	39"	6 ¹ / ₂ "
F	30"	29 ⁷ / ₈ "	29 ³ / ₄ "	6 ³ / ₈ "	27"	2"
F	36"	35 ⁷ / ₈ "	35 ³ / ₄ "	6 ³ / ₈ "	33"	2"
F	42"	41 ⁷ / ₈ "	41 ³ / ₄ "	6 ³ / ₈ "	39"	2"
H	30"	29 ⁷ / ₈ "	29 ³ / ₄ "	14 ¹⁵ / ₁₆ "	27"	6 ¹ / ₂ "
H	36"	35 ⁷ / ₈ "	35 ³ / ₄ "	14 ¹⁵ / ₁₆ "	33"	6 ¹ / ₂ "
H	42"	41 ⁷ / ₈ "	41 ³ / ₄ "	14 ¹⁵ / ₁₆ "	39"	6 ¹ / ₂ "

Meridian® Stackable™ Lateral Files

Tops/Modules/Bases/Options

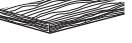
Frontless (23)

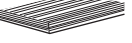
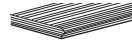
Spec-A-File

Tops	Description	Spec Code	H	D	W	LIST PRICE
No Top		NT				N/C
 Square Edge Metal Top	Metal top with square edge. Baked enamel finish.	T1	1"	20" or 18"	30"	\$ 54.
					36"	\$ 67.
					42"	\$ 82.
		T2	1 1/4"	20" or 18"	30"	\$ 54.
					36"	\$ 67.
					42"	\$ 82.
 Recessed Top	Metal top with 1 1/16" recessed front edge to allow a fascia strip to be attached to match the drawer fronts.	TA	1 1/4"	20" or 18"	30"	\$ 109.
					36"	\$ 122.
					42"	\$ 137.
 Radius Edge Metal Top	Metal top with radius edge front and back. Baked enamel finish.	T3	1 1/4"	20" or 18"	30"	\$ 109.
					36"	\$ 122.
					42"	\$ 137.
 Laminate Top with Vinyl Edge*	Laminate top with vinyl edge.	TL	1 1/4"	20" or 18"	30"	\$ 117.
					36"	\$ 130.
					42"	\$ 145.
 Cathedral Recut Veneer Top	Cathedral recut veneer top with 3mm edge banding.	J3 A	1 1/4"	20" or 18"	30"	\$ 189.
					36"	\$ 202.
					42"	\$ 217.
 Wood Veneer Top	Wood veneer top with 3mm edge banding.	TF A	1 1/4"	20" or 18"	30"	\$ 191.
					36"	\$ 204.
					42"	\$ 219.
 Recut Veneer Top	Recut veneer top with 3mm edge banding.	TR A	1 1/4"	20" or 18"	30"	\$ 186.
					36"	\$ 199.
					42"	\$ 214.
 Wood Veneer Top with Oversail Front Edge*	Wood veneer top and wood composite edge with oversail front.	TV1 A	1 1/8"	20" or 18"	30"	\$ 338.
					36"	\$ 351.
					42"	\$ 366.
 Security Top	Flat steel cover with baked enamel finish. Designed to protect contents and minimize overall height; not to be used for support or as an exposed top. Available on N, E and H modules only.	T6	1/32"	20" or 18"	30"	\$ 54.
					36"	\$ 67.
					42"	\$ 82.
 Planter Top*	Steel shell with baked enamel finish. Includes black plastic tub liner. Cannot house a lock.	T7	6 1/2"	20" or 18"	30"	\$ 231.
					36"	\$ 244.
					42"	\$ 259.





*** Note:**
When ordering a radius edge laminate top, laminate top with PVC edge banding, a veneer top with oversail edge, or planter top with a frontless product, an additional top is required if the file is to include a lock. Call Customer Service for details.

Meridian® Stackable™ Lateral Files Tops/Modules/Bases/Options – *Continued*

Frontless (23)

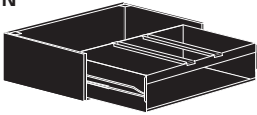
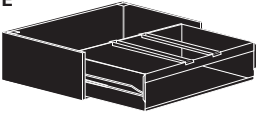
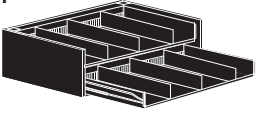
Spec-A-File



Modules	Description	Spec Code	H	D	W	Frontless (23)	LIST PRICE
11³/₄" High							
	File drawer / fixed front. Standard 9Q interior: hanging folder rails for front-to-back filing. Optional interiors: 9M, 9R, 9W-LT, 9W-LG, 9C-LT, 9C-LG. Interior depth: 17 ³ / ₄ " (20") or 15 ³ / ₄ " (18"). Interior height: 10 ⁵ / ₈ ". Hanging clearance: 9 ⁷ / ₁₆ " for 9Q, 9R, 9C-LG, 9C-LT.	N	11 ³ / ₄ "	20" or 18"	30"	\$ 246.	
					36"	\$ 268.	
					42"	\$ 307.	
13¹/₈" High							
	File drawer / fixed front. Standard 9Q interior: hanging folder rails for front-to-back filing. Optional interiors: 9M, 9R, 9W-LT, 9W-LG, 9C-LT, 9C-LG. Interior depth: 17 ³ / ₄ " (20") or 15 ³ / ₄ " (18"). Interior height: 12". Hanging clearance: 9 ⁷ / ₁₆ " for 9Q, 9R, 9C-LG, 9C-LT.	E	13 ¹ / ₈ "	20" or 18"	30"	\$ 246.	
					36"	\$ 268.	
					42"	\$ 307.	
	Two half height drawers / fixed fronts. Standard 9T interior: 3 adjustable partitions per half drawer for index card filing. Interior depth: 17 ³ / ₄ " (20") or 15 ³ / ₄ " (18") Interior height: 5 ³ / ₈ ".	F	13 ¹ / ₈ "	20" or 18"	30"	\$ 491.	
					36"	\$ 514.	
					42"	\$ 551.	
15¹/₈" High							
	File drawer / fixed front. Standard 9X interior: 2 rails for computer printout hanging binders and folders. Optional interiors: 9M, 9W-LT, 9W-LG. Interior depth: 17 ³ / ₄ " (20") or 15 ³ / ₄ " (18"). Interior height: 14". Hanging clearance: 11 ⁹ / ₁₆ " for 9X.	H	15 ¹ / ₈ "	20" or 18"	30"	\$ 344.	
					36"	\$ 368.	
					42"	\$ 405.	
Bases / Options							
	Frame-type steel base with baked enamel finish. Includes four adjustable leveling glides.	B1	1"	20" or 18"	30"	\$ 68.	
		B2	1 ¹ / ₂ "		36"	\$ 83.	
		B3	2 ¹ / ₄ "		42"	\$ 95.	
		B4	3 ¹ / ₄ "	20" or 18"	30"	\$ 100.	
		B5	4 ¹ / ₄ "		36"	\$ 115.	
		42"	\$ 127.				
	Frame-type steel base with baked enamel finish. Recessed 1 ¹ / ₁₆ ". Includes four adjustable leveling guides.	BA	1"	20" or 18"	30"	\$ 100.	
		BB	1 ¹ / ₂ "		36"	\$ 115.	
		BC	2 ¹ / ₄ "	20" or 18"	42"	\$ 127.	
		BD	3 ¹ / ₄ "				
Lock	Flush lock. Locks are located in the top in the frontless lateral file.	KD, KC or KA				\$ 32.	
Counterbalance Weight	Recommended for freestanding 2 and 3-high Lateral files.	CB				\$ 120.	
	Flat steel pan placed between modules of a lateral file stack. For use on N, E, F, H modules.	PN	1/32"	20" or 18"	30"	\$ 37.	
					36"	\$ 43.	
					42"	\$ 51.	

Note: List price upcharge is for quantity 1 security pan.

Meridian® Stackable™ Lateral Files Retrofit Interiors

The prices below are the retrofit prices for field installing these interiors in appropriate **existing** lateral file drawers. Option includes all parts and instructions. Be certain to specify the "part" number corresponding to the width and depth of file to be fitted.

Description				Description			
Description		Part Number	LIST PRICE	Description		Part Number	LIST PRICE
Front-To-Back Filing				Side-To-Side Filing			
9P	30" x 18"	9P0018	\$ 24.	9M ea	All 18"	9M10018	\$ 11.
9P	36" x 18"	9P3618	\$ 24.	9M ea	All 20"	9M10020	\$ 11.
9P	42" x 18"	9P0018	\$ 24.	9M set of 3	All 18"	9M30018	\$ 29.
9P	30" x 20"	9P0020	\$ 24.	9M set of 3	All 20"	9M30020	\$ 29.
9P	36" x 20"	9P3620	\$ 24.	9R ea	30" x 18/20"	9R13000	\$ 17.
9P	42" x 20"	9P0020	\$ 24.	9R ea	36" x 18/20"	9R13600	\$ 17.
9Q	30" x 18"	9Q3018	\$ 38.	9R ea	42" x 18/20"	9R14200	\$ 17.
9Q	36" x 18"	9Q3618	\$ 38.	9R set of 2	30" x 18/20"	9R23000	\$ 34.
9Q	42" x 18"	9Q4218	\$ 38.	9R set of 2	36" x 18/20"	9R23600	\$ 34.
9Q	30" x 20"	9Q3020	\$ 38.	9R set of 2	42" x 18/20"	9R24200	\$ 34.
9Q	36" x 20"	9Q3620	\$ 38.	9V	30" x 18"	9V3018	\$ 38.
9Q	42" x 20"	9Q4220	\$ 38.	9V	36" x 18"	9V3618	\$ 38.
9C-LT	30" x 18/20"	9C3000LT	\$ 38.	9V	42" x 18"	9V4218	\$ 38.
9C-LT	36" x 18/20"	9C3600LT	\$ 38.	9V	30" x 20"	9V3020	\$ 38.
9C-LT	42" x 18/20"	9C4200LT	\$ 38.	9V	36" x 20"	9V3620	\$ 38.
9C-LG	30" x 18/20"	9C3000LG	\$ 38.	9V	42" x 20"	9V4220	\$ 38.
9C-LG	36" x 18/20"	9C3600LG	\$ 38.	9X	30" x 18/20"	9X3000	\$ 32.
9C-LG	42" x 18/20"	9C4200LG	\$ 38.	9X	36" x 18/20"	9X3600	\$ 32.
9W-LT	30"/36" x 18"	9W0018LT	\$ 74.	9X	42" x 18/20"	9X4200	\$ 32.
9W-LT	42" x 18"	9W4218LT	\$ 82.	9Y ea	12"Hx5"Wx16"D	9Y10000	\$ 35.
9W-LT	30"/36" x 20"	9W0020LT	\$ 74.				
9W-LT	42" x 20"	9W4220LT	\$ 82.				
9W-LG	30" x 18"	9W3018LG	\$ 74.				
9W-LG	36"/42" x 18"	9W0018LG	\$ 82.				
9W-LG	30" x 20"	9W3020LG	\$ 74.				
9W-LG	36"/42" x 20"	9W0020LG	\$ 82.				
9T ea	All 18"	9T10018	\$ 11.				
9T ea	All 20"	9T10020	\$ 11.				
9T set of 6	All 18"	9T60018	\$ 52.				
9T set of 6	All 20"	9T60020	\$ 52.				

* Specify paint color

Meridian® Stackable™ Lateral Files Card Tray

Card Tray Interior

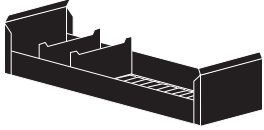

Description

Consists of removable card tray with 2 5 1/2" dividers for card filing. To be used only with modules F and B. Partial bottom with open center.

Card Trays (all sizes)

LIST PRICE

\$ 54.

Card Tray Interiors

Actual Dimension	Card Size	File Depth	Item No.	Drawer Width	Trays Per Drawer
5 3/8" w x 15 3/8" d x 5 1/4" h	3 x 5	18"	CT-3518	30"	4
				36"	6
				42"	7
5 3/8" w x 17 3/8" d x 5 1/4" h		20"	CT-3520	30"	4
				36"	6
				42"	7
6 3/8" w x 15 3/8" d x 5 1/4" h	4 x 6	18"	CT-4618	30"	4
				36"	5
				42"	6
6 3/8" w x 17 3/8" d x 5 1/4" h		20"	CT-4620	30"	4
				36"	5
				42"	6
8 3/8" w x 15 3/8" d x 5 1/4" h	5 x 8	18"	CT-5818	30"	3
				36"	3
				42"	4
8 3/8" w x 17 3/8" d x 5 1/4" h		20"	CT-5820	30"	3
				36"	3
				42"	4
9 3/8" w x 15 3/8" d x 5 1/4" h	4 x 9	18"	CT-4918	30"	2
				36"	3
				42"	4
9 3/8" w x 17 3/8" d x 5 1/4" h		20"	CT-4920	30"	2
				36"	3
				42"	4

Meridian® Stackable™ Lateral Files

Accessories

	Description	D	H	W	Item Number	Quantity	LIST PRICE
Movable Magnetic Divider 	Movable magnetic divider for storage of miscellaneous media. Side-to-side filing only. Available in black.	8"	9"		9Y10809	1	\$ 35.
		13"	12"		9Y11312	1	\$ 44.
		15"	9"		9Y11509	1	\$ 44.

File Drawer Organizer 	This two-sectioned organizer fits into any file drawer arranged for letter-size filing. The removable top section stores computer disks and other small items. The bottom section stores larger items or can be divided into 3 compartments; it includes 2 vertical dividers. Finish is black umber.	6"	9"	12 ⁷ / ₈ "	G5921.		\$ 46.
---	--	----	----	----------------------------------	--------	--	--------

Note: This organizer does not accept letter-size file folders.

Multi-Media Index Divider 	Multi-media index dividers for a variety of media types including diskettes, CD-ROMs, microfiche, microfilm and index cards. Includes 2 9T front-to-back dividers and 4 index dividers.	18"	3"	3"	A128-030318		\$ 54.
		20"	3"	3"	A128-030320		\$ 54.
		18"	3"	5"	A128-030518		\$ 54.
		20"	3"	5"	A128-030520		\$ 54.
		18"	4"	6"	A128-040618		\$ 54.
		20"	4"	6"	A128-040620		\$ 54.
		18"	6"	5"	A128-060518		\$ 54.
20"	6"	5"	A128-060520		\$ 54.		

EnhancedAccess™ Pulls  Loop Style	These plastic loop-style pulls slide into the standard pulls on pedestal or lateral file drawers. They make the drawers easier to open. Package contains 1 pull and attachment hardware.	Loop Style	EAP-L			\$ 37.
--	--	------------	-------	--	--	--------

For use with standard pull modules only.

Available in:

Black UMBER **BU**
 Inner Tone Light **HF**
 Medium Tone **MT**

Freestanding Stackable™ Lateral Files

Mobile Stackable™ Lateral Files

Stackable™ Lateral File Accessories



Standard-Pull Freestanding
Lateral File

26-30
26-36
26-42

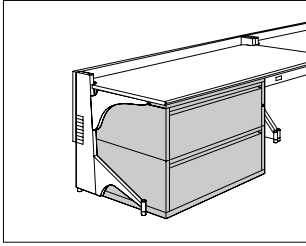

Product Information

Description

This lateral file holds letter-, legal-, and A4-size hanging files. It has standard pulls and smooth or textured steel. The file has no top or a metal, cushion, laminate, planter, or veneer top. A positive interlock system permits only 1 drawer to open at a time. 1 lock controls all drawers. The drawers can be specified with 3 dividers or with front-to-back or side-to-side filing rails for hanging files. The 5-high lateral file has 4 drawers and 1 flipper door; the flipper door includes a pullout shelf with 3 movable dividers. 5 base heights are available; all bases include adjustable glides.

Actual lateral file widths are 29⁷/₈" , 35⁷/₈" , or 41⁷/₈" ; actual depths are 17⁷/₈" or 19⁷/₈" .

Notes

For 2- or 3-high files that are not ganged or anchored, counterweights (option CB) are required. For 4- or 5-high files that are not ganged or anchored, counterweights are recommended.

When alternate drawer interior (9P, 9R, or 9M) is specified for 5-high lateral file, pullout shelf still includes 3 movable dividers.

Dimensional illustrations do not include all possible configurations.

To convert filing direction, order 1 of the following products separately:

- Front-to-back rail (9P002)
- Side-to-side rail (9R130)

Order optional file drawer organizer (LG901) separately.

For work surface on top of 1 or more lateral files, order file top (TPL or TPV) separately.

For cushion tops TC1 and TC2, a 1" metal top is included.

Cushion top accepts Customer's Own Material (COM). Yardage is estimated for nondirectional, 54"-wide fabrics. When ordering more than 1 cushion, round up total yardage requirement to next whole yard of fabric.

Width—Yardage

30" —1.05

36" —1.22

42" —1.40

For information on multiple quantities or directional fabrics, contact COM Department. See Order Information in Appendices.

For keyed-alike locks, order lock plugs separately. See Keyed-Alike Information in Appendices.

Dimensions

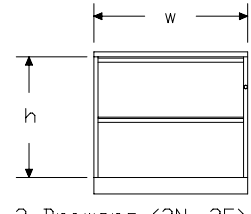
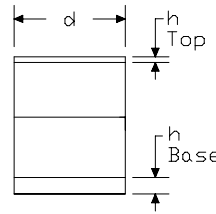

2 Drawers (2N, 2E)

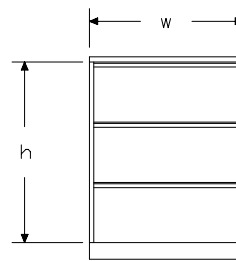

3 Drawers (3N, 3E)

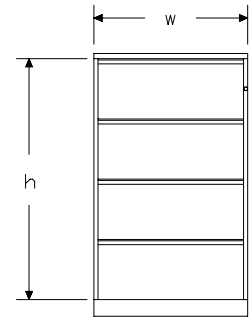

4 Drawers (4N, 4E)

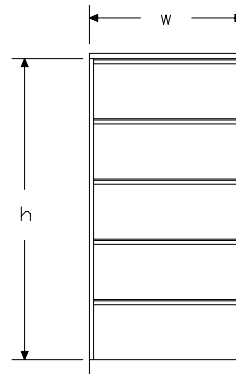

5 Drawers (5N)

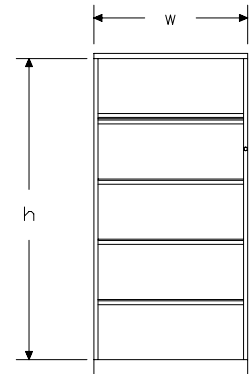

1 Flipper Door and 4 Drawers (5D, 5F)

h	N	E	D	F
2	23 1/2	26 1/4	-	-
3	35 1/4	39 3/8	-	-
4	47	52 1/2	-	-
5	58 3/4	-	60 1/8	65 5/8

All dimensions are in inches.

Standard-Pull Freestanding Lateral File *continued*

Specification Information								
Step 1.								
26-								
Step 2. Width								
30	30" wide							
36	36" wide							
42	42" wide							
Step 3. Depth								
18-	18" deep							
20-	20" deep							
Step 4. Configuration								
2N	2 11 ³ / ₄ "-high drawers							
3N	3 11 ³ / ₄ "-high drawers							
4N	4 11 ³ / ₄ "-high drawers							
5N	5 11 ³ / ₄ "-high drawers							
5D	1 13 ¹ / ₈ "-high flipper door and 4 11 ³ / ₄ "-high drawers							
2E	2 13 ¹ / ₈ "-high drawers							
3E	3 13 ¹ / ₈ "-high drawers							
4E	4 13 ¹ / ₈ "-high drawers							
5F	1 13 ¹ / ₈ "-high flipper door and 4 13 ¹ / ₈ "-high drawers							
Prices for Steps 1-4.								
		2N	3N	4N	5N	5D	2E	3E
26-30	18-	\$706	983	1262	1540	1579	706	983
	20-	\$706	983	1262	1540	1579	706	983
26-36	18-	\$784	1087	1391	1694	1733	784	1087
	20-	\$784	1087	1391	1694	1733	784	1087
26-42	18-	\$888	1230	1572	1915	1953	888	1230
	20-	\$888	1230	1572	1915	1953	888	1230
							4E	5F
26-30	18-						\$1262	1579
	20-						\$1262	1579
26-36	18-						\$1391	1733
	20-						\$1391	1733
26-42	18-						\$1572	1953
	20-						\$1572	1953

Step 5. Paint/Steel Type		
SS	smooth paint on smooth steel	+\$0
TS	smooth paint on textured steel	+\$0
XS	textured paint on smooth steel	+\$0
Step 6. Surface Finish		
<i>For smooth paint on smooth steel (SS) or smooth paint on textured steel (TS)</i>		
Nonmetallic Paint		+\$0
Metallic Paint		+\$65
Sand Texture Paint		
<i>For textured paint on smooth steel (XS)</i>		
7L	dune	+\$0
7M	chai	+\$0
7N	grass	+\$0
7U	blue ridge	+\$0
7V	loden	+\$0
7W	napa	+\$0
7Y	sedona	+\$0
7Z	mink	+\$0
8T	gull	+\$0
8Y	moonbeam	+\$0
B4	blue medium	+\$0
ZK	cappuccino	+\$0
Bright Sand Texture Paint		
<i>For textured paint on smooth steel (XS)</i>		
91	white	+\$0
CL	cool grey neutral	+\$0
G1	graphite	+\$0
WN	warm grey neutral	+\$0

Standard-Pull Freestanding Lateral File *continued*

Step 7. Top		
NT	no top	+\$0
T1	1"-high painted metal top with squared edge	+\$0
T2	1 1/4"-high painted metal top with squared edge	+\$0
T3	1 1/4"-high painted metal top with radius edge	+\$55
TL	1 1/4"-high laminate top with vinyl edge	+\$63
TR	1 1/4"-high recut veneer top A	+\$132
J3	1 1/4"-high cathedral recut veneer top A	+\$135
TF	1 1/4"-high wood veneer top A	+\$137
T7	6 1/2"-high planter top	+\$177
D1	6 1/2"-high full dome, side-to-side	+\$242
H1	6 1/2"-high half dome, sloping left	+\$242
H2	6 1/2"-high half dome, sloping right	+\$242
TV1	1 1/8"-high wood veneer top and wood composite edge with oversail front A	+\$284
TC1	1" cushion top	+\$350
TC2	2" cushion top	+\$350

Step 8. Lock		
KA	keyed alike	+\$0
KC	keyed differently, chrome	+\$0
KD	keyed differently, black	+\$0

Step 9.		
Top Finish: Solid-Color Laminate		
<i>For 1 1/4"-high laminate top with vinyl edge (TL)</i>		
8Q	folkstone grey	+\$0
91	white	+\$0
CL	cool grey neutral	+\$0
HF	inner tone light	+\$0
HT	inner tone	+\$0
LT	light tone	+\$0
LU	soft white	+\$0
WL	sandstone	+\$0
WN	warm grey neutral	+\$0

Top Finish: Fiber Laminate		
<i>For 1 1/4"-high laminate top with vinyl edge (TL)</i>		
1X	vanilla	+\$0
2X	wheat	+\$0
3X	celery	+\$0
4X	coriander	+\$0
5X	chamomile	+\$0
6X	cinnamon	+\$0
7X	cardamom	+\$0
8X	kale	+\$0

Top Finish: Frosted Laminate		
<i>For 1 1/4"-high laminate top with vinyl edge (TL)</i>		
J4	frosted light grey	+\$0
J5	frosted inner tone light	+\$0
J6	frosted slate grey	+\$0
J7	frosted medium tone	+\$0
J8	frosted black	+\$0

Top Finish: Wood-Grain Laminate		
<i>For 1 1/4"-high laminate top with vinyl edge (TL)</i>		
LA	light ash	+\$0
LM	mahogany	+\$0

Top Finish: Zephyr Laminate		
<i>For 1 1/4"-high laminate top with vinyl edge (TL)</i>		
D1	canyon	+\$0
DC	misted	+\$0
DF	twilight	+\$0
DQ	desert	+\$0

Veneer Top Finish: Recut Veneer		
<i>For 1 1/4"-high recut veneer top (TR)</i>		
RA	light ash A	+\$0
RK	mahogany dark A	+\$0
RM	mahogany A	+\$0

Veneer Top Finish: Recut Veneer		
<i>For 1 1/4"-high cathedral recut veneer top (J3)</i>		
DU	cathedral recut natural maple A	+\$0
HU	cathedral recut light anigre A	+\$0
JU	cathedral recut aged cherry A	+\$0
VU	cathedral recut light brown walnut A	+\$0
WU	cathedral recut walnut on cherry A	+\$0
XU	cathedral recut medium red cherry A	+\$0
ZU	cathedral recut chocolate brown sapele A	+\$0

Standard-Pull Freestanding Lateral File *continued*

Veneer Top Finish: Wood Veneer		
<i>For 1 1/4"-high wood veneer top (TF)</i>		
V3	cherry <input type="checkbox"/>	+\$21
Z3	warm red cherry <input type="checkbox"/>	+\$21
Z5	maple <input type="checkbox"/>	+\$21
2U	light brown walnut <input type="checkbox"/>	+\$28
3U	medium red cherry <input type="checkbox"/>	+\$28
6U	chocolate brown sapele <input type="checkbox"/>	+\$28
ED	aged cherry <input type="checkbox"/>	+\$28
EG	medium brown walnut <input type="checkbox"/>	+\$28
EK	medium red walnut <input type="checkbox"/>	+\$28
EY	light anigre <input type="checkbox"/>	+\$28
UL	natural maple <input type="checkbox"/>	+\$28
UQ	light cherry <input type="checkbox"/>	+\$28
UV	red cherry <input type="checkbox"/>	+\$28
UX	walnut on cherry <input type="checkbox"/>	+\$28

Veneer Top Finish: Wood Veneer		
<i>For 1 1/8"-high wood veneer top and wood composite edge with oversail front (TV1)</i>		
ED	aged cherry <input type="checkbox"/>	+\$28
EG	medium brown walnut <input type="checkbox"/>	+\$28
EK	medium red walnut <input type="checkbox"/>	+\$28
EY	light anigre <input type="checkbox"/>	+\$28
UL	natural maple <input type="checkbox"/>	+\$28
UQ	light cherry <input type="checkbox"/>	+\$28
UV	red cherry <input type="checkbox"/>	+\$28
UX	walnut on cherry <input type="checkbox"/>	+\$28

Step 10. Edge Finish		
<i>For 1 1/4"-high laminate top with vinyl edge (TL)</i>		
8Q	folkstone grey	+\$0
91	white	+\$0
BU	black umber	+\$0
CL	cool grey neutral	+\$0
CM	cinnamon	+\$0
CO	chamomile	+\$0
G2	graphite satin	+\$0
HF	inner tone light	+\$0
HT	inner tone	+\$0
LA	light ash	+\$0
LM	mahogany	+\$0
LU	soft white	+\$0
MT	medium tone	+\$0
SG	slate grey	+\$0
WL	sandstone	+\$0
WN	warm grey neutral	+\$0

Step 11. Cushion Top Fabric	
<i>For 1" cushion top (TC1) or 2" cushion top (TC2)</i>	
<i>See textiles list for fabric numbers. First 2 digits of number indicate fabric line; remaining digit(s) indicate fabric color.</i>	
Price Category 1	+\$0
Price Category 2	+\$55
Price Category 3	+\$67
Price Category 4	+\$82
Price Category 7	+\$137
Price Category 9	+\$950
Price Category B	+\$56
Price Category E	+\$139
Price Category G	+\$250
Price Category H	+\$333

Step 12. Base Height		
B1	1"-high base	+\$0
B2	1 1/2"-high base	+\$0
B3	2 1/4"-high base	+\$0
B4	3 1/4"-high base	+\$0
BA	1"-high recessed base	+\$32
BB	1 1/2"-high recessed base	+\$32
BC	2 1/4"-high recessed base	+\$32
BD	3 1/4"-high recessed base	+\$32
B5	4 1/4"-high base	+\$32

Step 13. Counterweight		
NO	no counterweight (must gang or anchor)	+\$0
CB	counterweight (recommended)	+\$115

Step 14. Drawer Interior		
9M	3 dividers	+\$0
9P	front-to-back filing rail	+\$0
9R	side-to-side filing rail	+\$0

Arc-Pull Freestanding Lateral File

2A-30
2A-36
2A-42
2D-30
2D-36
2D-42

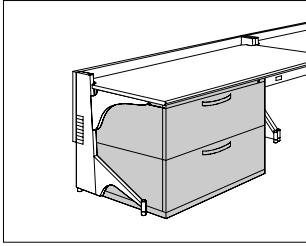

Product Information

Description

This lateral file holds letter-, legal-, and A4-size hanging files. It has arc pulls and smooth or textured steel. The file has no top or a metal, cushion, laminate, planter, or veneer top. A positive interlock system permits only 1 drawer to open at a time. 1 lock controls all drawers. The drawers can be specified with 3 dividers or with front-to-back or side-to-side filing rails for hanging files. 5 base heights are available; all bases include adjustable glides.

Actual lateral file widths are 29⁷/₈" , 35⁷/₈" , or 41⁷/₈" ; actual depths are 17⁷/₈" or 19⁷/₈" .

Notes

For 2- or 3-high files that are not ganged or anchored, counterweights (option CB) are required. For 4- or 5-high files that are not ganged or anchored, counterweights are recommended.

Dimensional illustrations do not include all possible configurations.

To convert filing direction, order 1 of the following products separately:

- Front-to-back rail (9P002)
- Side-to-side rail (9R130)

Order optional file drawer organizer (LG901) separately.

For work surface on top of 1 or more lateral files, order file top (TPL or TPV) separately.

No lock option (NL) can only be specified on files with no top (NT), dome tops (D1, H1, or H2), planter top (T7), laminate tops (TL), or veneer top (TV1).

For cushion tops TC1 and TC2, a 1" metal top is included.

Grain direction is vertical for veneer-front lateral files.

Cushion top accepts Customer's Own Material (COM). Yardage is estimated for nondirectional, 54"-wide fabrics. When ordering more than 1 cushion, round up total yardage requirement to next whole yard of fabric.

Width—Yardage

30" — 1.05

36" — 1.22

42" — 1.40

For information on multiple quantities or directional fabrics, contact COM Department. See Order Information in Appendices.

For keyed-alike locks, order lock plugs separately. See Keyed-Alike Information in Appendices.

Dimensions

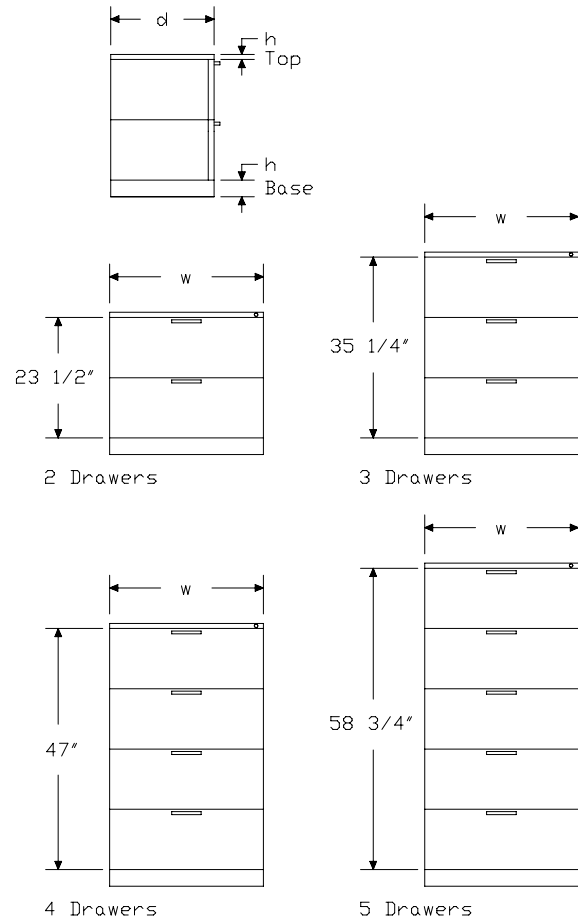

Arc-Pull Freestanding Lateral File

continued

Meridian® Freestanding Stackable™ Lateral Files

Specification Information

Step 1.

2

Step 2. Front Material

- D-** painted metal front
- A-** veneer front A

Step 3. Width

- 30** 30" wide
- 36** 36" wide
- 42** 42" wide

Step 4. Depth

- 18-** 18" deep
- 20-** 20" deep

Step 5. Configuration

- 2N** 2 drawers
- 3N** 3 drawers
- 4N** 4 drawers
- 5N** 5 drawers

Prices for Steps 1-5.

		2N	3N	4N	5N
2D-30	18-	\$706	983	1262	1540
	20-	\$706	983	1262	1540
2D-36	18-	\$784	1087	1391	1694
	20-	\$784	1087	1391	1694
2D-42	18-	\$888	1230	1572	1915
	20-	\$888	1230	1572	1915
2A-30	18-	\$996	1419	1842	2266
	20-	\$996	1419	1842	2266
2A-36	18-	\$1132	1609	2088	2565
	20-	\$1132	1609	2088	2565
2A-42	18-	\$1291	1835	2381	2924
	20-	\$1291	1835	2381	2924

Step 6. Paint/Steel Type

- SS** smooth paint on smooth steel +\$0
- TS** smooth paint on textured steel +\$0
- XS** textured paint on smooth steel +\$0

Step 7. Surface Finish

For smooth paint on smooth steel (SS) or smooth paint on textured steel (TS)

- Nonmetallic Paint +\$0
- Metallic Paint +\$65

Sand Texture Paint

For textured paint on smooth steel (XS)

- 7L** dune +\$0
- 7M** chai +\$0
- 7N** grass +\$0
- 7U** blue ridge +\$0
- 7V** loden +\$0
- 7W** napa +\$0
- 7Y** sedona +\$0
- 7Z** mink +\$0
- 8T** gull +\$0
- 8Y** moonbeam +\$0
- B4** blue medium +\$0
- ZK** cappuccino +\$0

Bright Sand Texture Paint

For textured paint on smooth steel (XS)

- 91** white +\$0
- CL** cool grey neutral +\$0
- G1** graphite +\$0
- WN** warm grey neutral +\$0

Arc-Pull Freestanding Lateral File

continued

Step 8. Top

For painted metal front (D-)

NT	no top	+\$0
T1	1"-high painted metal top with squared edge	+\$0
T2	1 1/4"-high painted metal top with squared edge	+\$0
T3	1 1/4"-high painted metal top with radius edge	+\$55
TL	1 1/4"-high laminate top with vinyl edge	+\$63
TR	1 1/4"-high recut veneer top A	+\$132
J3	1 1/4"-high cathedral recut veneer top A	+\$135
TF	1 1/4"-high wood veneer top A	+\$137
T7	6 1/2"-high planter top	+\$177
D1	6 1/2"-high full dome, side-to-side	+\$242
H1	6 1/2"-high half dome, sloping left	+\$242
H2	6 1/2"-high half dome, sloping right	+\$242
TV1	1 1/8"-high wood veneer top and wood composite edge with oversail front A	+\$284
TC1	1" cushion top	+\$350
TC2	2" cushion top	+\$350

For veneer front (A-)

NT	no top	+\$0
T1	1"-high painted metal top with squared edge	+\$0
T2	1 1/4"-high painted metal top with squared edge	+\$0
T3	1 1/4"-high painted metal top with radius edge	+\$55
TL	1 1/4"-high laminate top with vinyl edge	+\$63
J3	1 1/4"-high cathedral recut veneer top A	+\$135
TF	1 1/4"-high wood veneer top A	+\$137
T7	6 1/2"-high planter top	+\$177
D1	6 1/2"-high full dome, side-to-side	+\$242
H1	6 1/2"-high half dome, sloping left	+\$242
H2	6 1/2"-high half dome, sloping right	+\$242
TV1	1 1/8"-high wood veneer top and wood composite edge with oversail front A	+\$284
TC1	1" cushion top	+\$350
TC2	2" cushion top	+\$350

Step 9.

Veneer Top Finish: Wood Veneer

For painted metal front (D-) with 1 1/8"-high wood veneer top and wood composite edge with oversail front (TV1)

ED	aged cherry A	+\$28
EG	medium brown walnut A	+\$28
EK	medium red walnut A	+\$28
EY	light anigre A	+\$28
UL	natural maple A	+\$28
UQ	light cherry A	+\$28
UV	red cherry A	+\$28
UX	walnut on cherry A	+\$28

Veneer Top Finish: Recut Veneer

For painted metal front (D-) with 1 1/4"-high recut veneer top (TR)

RA	light ash A	+\$0
RK	mahogany dark A	+\$0
RM	mahogany A	+\$0

Veneer Top Finish: Recut Veneer

For painted metal front (D-) with 1 1/4"-high cathedral recut veneer top (J3)

DU	cathedral recut natural maple A	+\$0
HU	cathedral recut light anigre A	+\$0
JU	cathedral recut aged cherry A	+\$0
VU	cathedral recut light brown walnut A	+\$0
WU	cathedral recut walnut on cherry A	+\$0
XU	cathedral recut medium red cherry A	+\$0
ZU	cathedral recut chocolate brown sapele A	+\$0

Veneer Top Finish: Wood Veneer

For painted metal front (D-) with 1 1/4"-high wood veneer top (TF)

V3	cherry A	+\$21
Z3	warm red cherry A	+\$21
Z5	maple A	+\$21
2U	light brown walnut A	+\$28
3U	medium red cherry A	+\$28
6U	chocolate brown sapele A	+\$28
ED	aged cherry A	+\$28
EG	medium brown walnut A	+\$28
EK	medium red walnut A	+\$28
EY	light anigre A	+\$28
UL	natural maple A	+\$28
UQ	light cherry A	+\$28
UV	red cherry A	+\$28
UX	walnut on cherry A	+\$28

Arc-Pull Freestanding Lateral File

continued

Meridian® Freestanding Stackable™ Lateral Files

Veneer Front Finish: Recut Veneer

For veneer front (A-) with no top (NT), 1"-high painted metal top with squared edge (T1), 1 1/4"-high painted metal top with squared edge (T2), 1 1/4"-high painted metal top with radius edge (T3), 1 1/4"-high laminate top with vinyl edge (TL), 6 1/2"-high planter top (T7), 6 1/2"-high full dome, side-to-side (D1), 6 1/2"-high half dome, sloping left (H1), 6 1/2"-high half dome, sloping right (H2), 1" cushion top (TC1), or 2" cushion top (TC2)

DU	cathedral recut natural maple A	+\$0
HU	cathedral recut light anigre A	+\$0
JU	cathedral recut aged cherry A	+\$0
VU	cathedral recut light brown walnut A	+\$0
WU	cathedral recut walnut on cherry A	+\$0
XU	cathedral recut medium red cherry A	+\$0
ZU	cathedral recut chocolate brown sapele A	+\$0

Veneer Front Finish: Wood Veneer

For veneer front (A-) with no top (NT), 1"-high painted metal top with squared edge (T1), 1 1/4"-high painted metal top with squared edge (T2), 1 1/4"-high painted metal top with radius edge (T3), 1 1/4"-high laminate top with vinyl edge (TL), 6 1/2"-high planter top (T7), 6 1/2"-high full dome, side-to-side (D1), 6 1/2"-high half dome, sloping left (H1), 6 1/2"-high half dome, sloping right (H2), 1" cushion top (TC1), or 2" cushion top (TC2)

V3	cherry A	+\$42
Z3	warm red cherry A	+\$42
Z5	maple A	+\$42
2U	light brown walnut A	+\$56
3U	medium red cherry A	+\$56
6U	chocolate brown sapele A	+\$56
ED	aged cherry A	+\$56
EG	medium brown walnut A	+\$56
EK	medium red walnut A	+\$56
EY	light anigre A	+\$56
UL	natural maple A	+\$56
UQ	light cherry A	+\$56
UV	red cherry A	+\$56
UX	walnut on cherry A	+\$56

Veneer Front/Top Finish: Wood Veneer

For veneer front (A-) with 1 1/8"-high wood veneer top and wood composite edge with oversail front (TV1)

ED	aged cherry A	+\$56
EG	medium brown walnut A	+\$56
EK	medium red walnut A	+\$56
EY	light anigre A	+\$56
UL	natural maple A	+\$56
UQ	light cherry A	+\$56
UV	red cherry A	+\$56
UX	walnut on cherry A	+\$56

Veneer Front/Top Finish: Recut Veneer

For veneer front (A-) with 1 1/4"-high cathedral recut veneer top (J3)

DU	cathedral recut natural maple A	+\$0
HU	cathedral recut light anigre A	+\$0
JU	cathedral recut aged cherry A	+\$0
VU	cathedral recut light brown walnut A	+\$0
WU	cathedral recut walnut on cherry A	+\$0
XU	cathedral recut medium red cherry A	+\$0
ZU	cathedral recut chocolate brown sapele A	+\$0

Veneer Front/Top Finish: Wood Veneer

For veneer front (A-) with 1 1/4"-high wood veneer top (TF)

V3	cherry A	+\$42
Z3	warm red cherry A	+\$42
Z5	maple A	+\$42
2U	light brown walnut A	+\$56
3U	medium red cherry A	+\$56
6U	chocolate brown sapele A	+\$56
ED	aged cherry A	+\$56
EG	medium brown walnut A	+\$56
EK	medium red walnut A	+\$56
EY	light anigre A	+\$56
UL	natural maple A	+\$56
UQ	light cherry A	+\$56
UV	red cherry A	+\$56
UX	walnut on cherry A	+\$56

Arc-Pull Freestanding Lateral File

continued

Step 10. Top Finish For 1¹/₄"-high laminate top with vinyl edge (TL)

Solid-Color Laminate

8Q	folkstone grey	+\$0
91	white	+\$0
CL	cool grey neutral	+\$0
HF	inner tone light	+\$0
HT	inner tone	+\$0
LT	light tone	+\$0
LU	soft white	+\$0
WL	sandstone	+\$0
WN	warm grey neutral	+\$0

Fiber Laminate

1X	vanilla	+\$0
2X	wheat	+\$0
3X	celery	+\$0
4X	coriander	+\$0
5X	chamomile	+\$0
6X	cinnamon	+\$0
7X	cardamom	+\$0
8X	kale	+\$0

Frosted Laminate

J4	frosted light grey	+\$0
J5	frosted inner tone light	+\$0
J6	frosted slate grey	+\$0
J7	frosted medium tone	+\$0
J8	frosted black	+\$0

Wood-Grain Laminate

LA	light ash	+\$0
LM	mahogany	+\$0

Zephyr Laminate

D1	canyon	+\$0
DC	misted	+\$0
DF	twilight	+\$0
DQ	desert	+\$0

Step 11. Edge Finish For 1¹/₄"-high laminate top with vinyl edge (TL)

8Q	folkstone grey	+\$0
91	white	+\$0
BU	black umber	+\$0
CL	cool grey neutral	+\$0
CM	cinnamon	+\$0
CO	chamomile	+\$0
G2	graphite satin	+\$0
HF	inner tone light	+\$0
HT	inner tone	+\$0
LA	light ash	+\$0
LM	mahogany	+\$0
LU	soft white	+\$0
MT	medium tone	+\$0
SG	slate grey	+\$0
WL	sandstone	+\$0
WN	warm grey neutral	+\$0

Step 12. Cushion Top Fabric

For 1" cushion top (TC1) or 2" cushion top (TC2)

See textiles list for fabric numbers. First 2 digits of number indicate fabric line; remaining digit(s) indicate fabric color.

Price Category 1	+\$0
Price Category 2	+\$55
Price Category 3	+\$67
Price Category 4	+\$82
Price Category 7	+\$137
Price Category 9	+\$950
Price Category B	+\$56
Price Category E	+\$139
Price Category G	+\$250
Price Category H	+\$333

Step 13. Lock

For no top (NT), 1¹/₄"-high laminate top with vinyl edge (TL), 6¹/₂"-high planter top (T7), 6¹/₂"-high full dome, side-to-side (D1), 6¹/₂"-high half dome, sloping left (H1), 6¹/₂"-high half dome, sloping right (H2), or 1¹/₈"-high wood veneer top and wood composite edge with oversail front (TV1)

NL	no lock	-\$26
-----------	---------	-------

Arc-Pull Freestanding Lateral File

continued

Meridian® Freestanding Stackable™ Lateral Files

For 1"-high painted metal top with squared edge (T1), 1/4"-high painted metal top with squared edge (T2), 1/4"-high painted metal top with radius edge (T3), 1/4"-high recut veneer top (TR), 1/4"-high cathedral recut veneer top (J3), 1/4"-high wood veneer top (TF), 1" cushion top (TC1), or 2" cushion top (TC2)

KA	keyed alike	+\$0
KC	keyed differently, chrome	+\$0
KD	keyed differently, black	+\$0

Step 14. Pull Finish

BW	warm bronze	+\$40
NH	brushed nickel	+\$40
NK	black nickel	+\$40

Step 15. Base Height

B1	1"-high base	+\$0
B2	1 1/2"-high base	+\$0
B3	2 1/4"-high base	+\$0
B4	3 1/4"-high base	+\$0
BA	1"-high recessed base	+\$32
BB	1 1/2"-high recessed base	+\$32
BC	2 1/4"-high recessed base	+\$32
BD	3 1/4"-high recessed base	+\$32
B5	4 1/4"-high base	+\$32

Step 16. Counterweight

NO	no counterweight (must gang or anchor)	+\$0
CB	counterweight (recommended)	+\$115

Step 17. Drawer Interior

9P	front-to-back filing rail	+\$0
9R	side-to-side filing rail	+\$0
9M	3 dividers	+\$0

Bevel-Pull Freestanding Lateral File

24-30
24-36
24-42

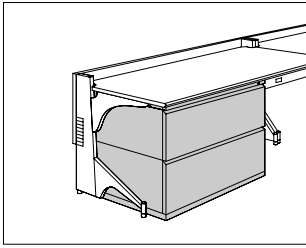

Product Information

Description

This lateral file holds letter-, legal-, and A4-size hanging files. It has bevel pulls and smooth or textured steel. The file has no top or a metal, cushion, laminate, planter, or veneer top. A positive interlock system permits only 1 drawer to open at a time. 1 lock controls all drawers. The drawers can be specified with 3 dividers or with front-to-back or side-to-side filing rails for hanging files. 5 base heights are available; all bases include adjustable glides.

Actual lateral file widths are 29⁷/₈" , 35⁷/₈" , or 41⁷/₈" ; actual depths are 17⁷/₈" or 19⁷/₈" .

Notes

For 2- or 3-high files that are not ganged or anchored, counterweights (option CB) are required. For 4- or 5-high files that are not ganged or anchored, counterweights are recommended.

Dimensional illustrations do not include all possible configurations.

To convert filing direction, order 1 of the following products separately:

- Front-to-back rail (9P002)
- Side-to-side rail (9R130)

Order optional file drawer organizer (LG901) separately.

For work surface on top of 1 or more lateral files, order file top (TPL or TPV) separately.

No lock option (NL) can only be specified on files with no top (NT), dome tops (D1, H1, or H2), planter top (T7), laminate tops (TL), or veneer top (TV1).

For cushion tops TC1 and TC2, a 1" metal top is included.

Cushion top accepts Customer's Own Material (COM). Yardage is estimated for nondirectional, 54"-wide fabrics. When ordering more than 1 cushion, round up total yardage requirement to next whole yard of fabric.

Width—Yardage

30" — 1.05

36" — 1.22

42" — 1.40

For information on multiple quantities or directional fabrics, contact COM Department. See Order Information in Appendices.

For keyed-alike locks, order lock plugs separately. See Keyed-Alike Information in Appendices.

Dimensions

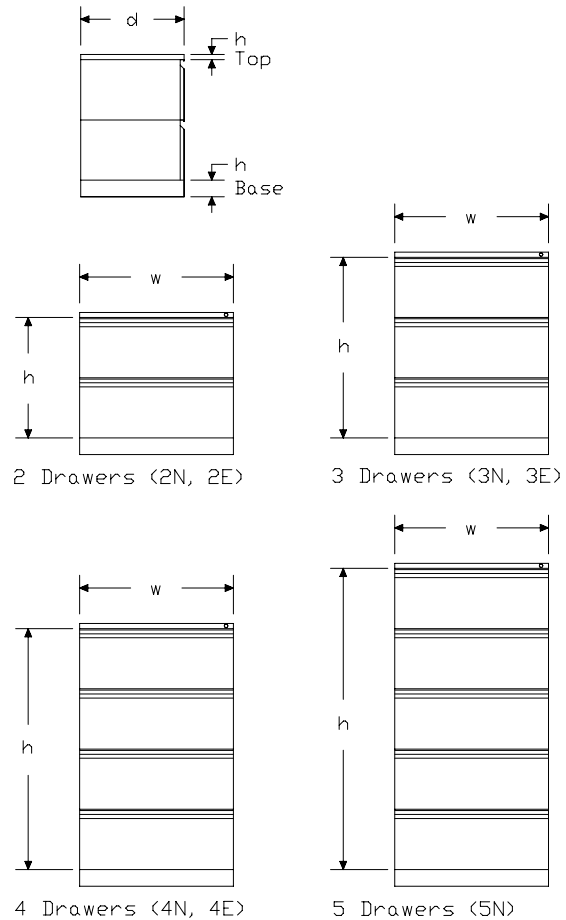

h	N	E
2	23 1/2	26 1/4
3	35 1/4	39 3/8
4	47	52 1/2
5	58 3/4	-

All dimensions are in inches.

Bevel-Pull Freestanding Lateral

File *continued*

Meridian® Freestanding Stackable™ Lateral Files

Specification Information								
Step 1.								
24-								
Step 2. Width								
30	30" wide							
36	36" wide							
42	42" wide							
Step 3. Depth								
18-	18" deep							
20-	20" deep							
Step 4. Configuration								
2N	2 11 ³ / ₄ "-high drawers							
3N	3 11 ³ / ₄ "-high drawers							
4N	4 11 ³ / ₄ "-high drawers							
5N	5 11 ³ / ₄ "-high drawers							
2E	2 13 ¹ / ₈ "-high drawers							
3E	3 13 ¹ / ₈ "-high drawers							
4E	4 13 ¹ / ₈ "-high drawers							
Prices for Steps 1-4.								
		2N	3N	4N	5N	2E	3E	4E
24-30	18-	\$706	983	1262	1540	706	983	1262
	20-	\$706	983	1262	1540	706	983	1262
24-36	18-	\$784	1087	1391	1694	784	1087	1391
	20-	\$784	1087	1391	1694	784	1087	1391
24-42	18-	\$888	1230	1572	1915	888	1230	1572
	20-	\$888	1230	1572	1915	888	1230	1572
Step 5. Paint/Steel Type								
SS	smooth paint on smooth steel							+\$0
TS	smooth paint on textured steel							+\$0
XS	textured paint on smooth steel							+\$0
Step 6. Surface Finish								
<i>For smooth paint on smooth steel (SS) or smooth paint on textured steel (TS)</i>								
Nonmetallic Paint							+\$0	
Metallic Paint							+\$65	

Sand Texture Paint		
<i>For textured paint on smooth steel (XS)</i>		
7L	dune	+\$0
7M	chai	+\$0
7N	grass	+\$0
7U	blue ridge	+\$0
7V	loden	+\$0
7W	napa	+\$0
7Y	sedona	+\$0
7Z	mink	+\$0
8T	gull	+\$0
8Y	moonbeam	+\$0
B4	blue medium	+\$0
ZK	cappuccino	+\$0
Bright Sand Texture Paint		
<i>For textured paint on smooth steel (XS)</i>		
91	white	+\$0
CL	cool grey neutral	+\$0
G1	graphite	+\$0
WN	warm grey neutral	+\$0
Step 7. Top		
NT	no top	+\$0
T1	1"-high painted metal top with squared edge	+\$0
T2	1 ¹ / ₄ "-high painted metal top with squared edge	+\$0
T3	1 ¹ / ₄ "-high painted metal top with radius edge	+\$55
TL	1 ¹ / ₄ "-high laminate top with vinyl edge	+\$63
TR	1 ¹ / ₄ "-high recut veneer top A	+\$132
J3	1 ¹ / ₄ "-high cathedral recut veneer top A	+\$135
TF	1 ¹ / ₄ "-high wood veneer top A	+\$137
T7	6 ¹ / ₂ "-high planter top	+\$177
D1	6 ¹ / ₂ "-high full dome, side-to-side	+\$242
H1	6 ¹ / ₂ "-high half dome, sloping left	+\$242
H2	6 ¹ / ₂ "-high half dome, sloping right	+\$242
TV1	1 ¹ / ₈ "-high wood veneer top and wood composite edge with oversail front A	+\$284
TC1	1" cushion top	+\$350
TC2	2" cushion top	+\$350

Bevel-Pull Freestanding Lateral File *continued*

Step 8. Lock

For no top (NT), 1¹/₄"-high laminate top with vinyl edge (TL), 6¹/₂"-high planter top (T7), 6¹/₂"-high full dome, side-to-side (D1), 6¹/₂"-high half dome, sloping left (H1), 6¹/₂"-high half dome, sloping right (H2), or 1¹/₈"-high wood veneer top and wood composite edge with oversail front (TV1)

NL no lock -\$26

For 1"-high painted metal top with squared edge (T1), 1¹/₄"-high painted metal top with squared edge (T2), 1¹/₄"-high painted metal top with radius edge (T3), 1¹/₄"-high recut veneer top (TR), 1¹/₄"-high cathedral recut veneer top (J3), 1¹/₄"-high wood veneer top (TF), 1" cushion top (TC1), or 2" cushion top (TC2)

KA keyed alike +\$0
KC keyed differently, chrome +\$0
KD keyed differently, black +\$0

Step 9.

Top Finish: Solid-Color Laminate

For 1¹/₄"-high laminate top with vinyl edge (TL)

8Q folkstone grey +\$0
91 white +\$0
CL cool grey neutral +\$0
HF inner tone light +\$0
HT inner tone +\$0
LT light tone +\$0
LU soft white +\$0
WL sandstone +\$0
WN warm grey neutral +\$0

Top Finish: Fiber Laminate

For 1¹/₄"-high laminate top with vinyl edge (TL)

1X vanilla +\$0
2X wheat +\$0
3X celery +\$0
4X coriander +\$0
5X chamomile +\$0
6X cinnamon +\$0
7X cardamom +\$0
8X kale +\$0

Top Finish: Frosted Laminate

For 1¹/₄"-high laminate top with vinyl edge (TL)

J4 frosted light grey +\$0
J5 frosted inner tone light +\$0
J6 frosted slate grey +\$0
J7 frosted medium tone +\$0
J8 frosted black +\$0

Top Finish: Wood-Grain Laminate

For 1¹/₄"-high laminate top with vinyl edge (TL)

LA light ash +\$0
LM mahogany +\$0

Top Finish: Zephyr Laminate

For 1¹/₄"-high laminate top with vinyl edge (TL)

D1 canyon +\$0
DC misted +\$0
DF twilight +\$0
DQ desert +\$0

Veneer Top Finish: Recut Veneer

For 1¹/₄"-high recut veneer top (TR)

RA light ash A +\$0
RK mahogany dark A +\$0
RM mahogany A +\$0

Veneer Top Finish: Recut Veneer

For 1¹/₄"-high cathedral recut veneer top (J3)

DU cathedral recut natural maple A +\$0
HU cathedral recut light anigre A +\$0
JU cathedral recut aged cherry A +\$0
VU cathedral recut light brown walnut A +\$0
WU cathedral recut walnut on cherry A +\$0
XU cathedral recut medium red cherry A +\$0
ZU cathedral recut chocolate brown sapele A +\$0

Bevel-Pull Freestanding Lateral

File *continued*

Veneer Top Finish: Wood Veneer		
<i>For 1 1/4"-high wood veneer top (TF)</i>		
V3	cherry <input type="checkbox"/>	+\$21
Z3	warm red cherry <input type="checkbox"/>	+\$21
Z5	maple <input type="checkbox"/>	+\$21
2U	light brown walnut <input type="checkbox"/>	+\$28
3U	medium red cherry <input type="checkbox"/>	+\$28
6U	chocolate brown sapele <input type="checkbox"/>	+\$28
ED	aged cherry <input type="checkbox"/>	+\$28
EG	medium brown walnut <input type="checkbox"/>	+\$28
EK	medium red walnut <input type="checkbox"/>	+\$28
EY	light anigre <input type="checkbox"/>	+\$28
UL	natural maple <input type="checkbox"/>	+\$28
UQ	light cherry <input type="checkbox"/>	+\$28
UV	red cherry <input type="checkbox"/>	+\$28
UX	walnut on cherry <input type="checkbox"/>	+\$28

Veneer Top Finish: Wood Veneer		
<i>For 1 1/8"-high wood veneer top and wood composite edge with oversail front (TV1)</i>		
ED	aged cherry <input type="checkbox"/>	+\$28
EG	medium brown walnut <input type="checkbox"/>	+\$28
EK	medium red walnut <input type="checkbox"/>	+\$28
EY	light anigre <input type="checkbox"/>	+\$28
UL	natural maple <input type="checkbox"/>	+\$28
UQ	light cherry <input type="checkbox"/>	+\$28
UV	red cherry <input type="checkbox"/>	+\$28
UX	walnut on cherry <input type="checkbox"/>	+\$28

Step 10. Edge Finish		
<i>For 1 1/4"-high laminate top with vinyl edge (TL)</i>		
8Q	folkstone grey	+\$0
91	white	+\$0
BU	black umber	+\$0
CL	cool grey neutral	+\$0
CM	cinnamon	+\$0
CO	chamomile	+\$0
G2	graphite satin	+\$0
HF	inner tone light	+\$0
HT	inner tone	+\$0
LA	light ash	+\$0
LM	mahogany	+\$0
LU	soft white	+\$0
MT	medium tone	+\$0
SG	slate grey	+\$0
WL	sandstone	+\$0
WN	warm grey neutral	+\$0

Step 11. Cushion Top Fabric	
<i>For 1" cushion top (TC1) or 2" cushion top (TC2)</i>	
<i>See textiles list for fabric numbers. First 2 digits of number indicate fabric line; remaining digit(s) indicate fabric color.</i>	
Price Category 1	+\$0
Price Category 2	+\$55
Price Category 3	+\$67
Price Category 4	+\$82
Price Category 7	+\$137
Price Category 9	+\$950
Price Category B	+\$56
Price Category E	+\$139
Price Category G	+\$250
Price Category H	+\$333

Step 12. Base Height		
B1	1"-high base	+\$0
B2	1 1/2"-high base	+\$0
B3	2 1/4"-high base	+\$0
B4	3 1/4"-high base	+\$0
BA	1"-high recessed base	+\$32
BB	1 1/2"-high recessed base	+\$32
BC	2 1/4"-high recessed base	+\$32
BD	3 1/4"-high recessed base	+\$32
B5	4 1/4"-high base	+\$32

Step 13. Counterweight		
NO	no counterweight (must gang or anchor)	+\$0
CB	counterweight (recommended)	+\$115

Step 14. Drawer Interior		
9P	front-to-back filing rail	+\$0
9R	side-to-side filing rail	+\$0
9M	3 dividers	+\$0

Contour-Pull Freestanding Lateral File 25-30
 File 25-36
 25-42

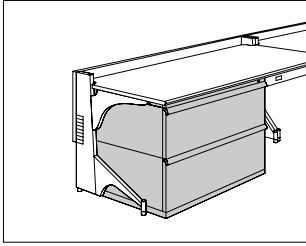

Product Information

Description

This lateral file holds letter-, legal-, and A4-size hanging files. It has stained wood or painted aluminum contour pulls and smooth or textured steel. The file has no top or a metal, cushion, laminate, planter, or veneer top. A positive interlock system permits only 1 drawer to open at a time. 1 lock controls all drawers. The drawers can be specified with 3 dividers or with front-to-back or side-to-side filing rails for hanging files. 5 base heights are available; all bases include adjustable glides. Actual lateral file widths are 29⁷/₈" , 35⁷/₈" , or 41⁷/₈" ; actual depths are 17⁷/₈" or 19⁷/₈" .

Notes

For 2- or 3-high files that are not ganged or anchored, counterweights (option CB) are required. For 4- or 5-high files that are not ganged or anchored, counterweights are recommended.

Dimensional illustrations do not include all possible configurations.

To convert filing direction, order 1 of the following products separately:

- Front-to-back rail (9P002)
- Side-to-side rail (9R130)

Order optional file drawer organizer (LG901) separately.

For work surface on top of 1 or more lateral files, order file top (TPL or TPV) separately.

No lock option (NL) can only be specified on files with no top (NT), dome tops (D1, H1, or H2), planter top (T7), laminate tops (TL), or veneer top (TV1).

For cushion tops TC1 and TC2, a 1" metal top is included.

Cushion top accepts Customer's Own Material (COM). Yardage is estimated for nondirectional, 54"-wide fabrics. When ordering more than 1 cushion, round up total yardage requirement to next whole yard of fabric.

Width—Yardage

30" —1.05

36" —1.22

42" —1.40

For information on multiple quantities or directional fabrics, contact COM Department. See Order Information in Appendices.

For keyed-alike locks, order lock plugs separately. See Keyed-Alike Information in Appendices.

Dimensions

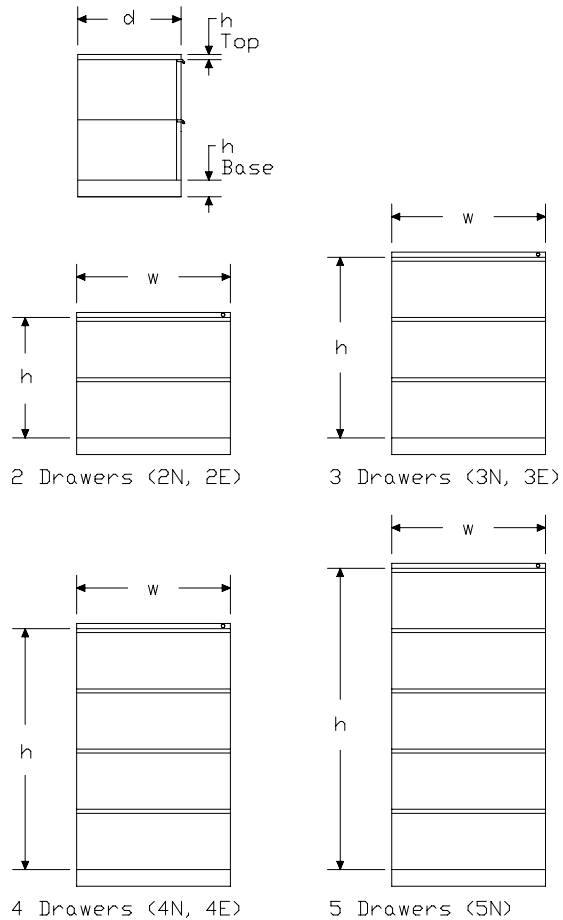

h	N	E
2	23 1/2	26 1/4
3	35 1/4	39 3/8
4	47	52 1/2
5	58 3/4	-

All dimensions are in inches.

Contour-Pull Freestanding Lateral

File *continued*

Meridian® Freestanding Stackable™ Lateral Files

Specification Information

Step 1.

25-

Step 2. Width

30 30" wide
36 36" wide
42 42" wide

Step 3. Depth

18- 18" deep
20- 20" deep

Step 4. Configuration

2N 2 11³/₄"-high drawers
3N 3 11³/₄"-high drawers
4N 4 11³/₄"-high drawers
5N 5 11³/₄"-high drawers
2E 2 13¹/₈"-high drawers
3E 3 13¹/₈"-high drawers
4E 4 13¹/₈"-high drawers

Prices for Steps 1-4.

		2N	3N	4N	5N	2E	3E	4E
25-30	18-	\$841	1186	1532	1879	841	1186	1532
	20-	\$841	1186	1532	1879	841	1186	1532
25-36	18-	\$945	1330	1714	2100	945	1330	1714
	20-	\$945	1330	1714	2100	945	1330	1714
25-42	18-	\$1081	1520	1959	2400	1081	1520	1959
	20-	\$1081	1520	1959	2400	1081	1520	1959

Step 5. Paint/Steel Type

SS smooth paint on smooth steel +\$0
TS smooth paint on textured steel +\$0
XS textured paint on smooth steel +\$0

Step 6. Surface Finish

For smooth paint on smooth steel (SS) or smooth paint on textured steel (TS)

Nonmetallic Paint +\$0
 Metallic Paint +\$65

Sand Texture Paint

For textured paint on smooth steel (XS)

7L dune +\$0
7M chai +\$0
7N grass +\$0
7U blue ridge +\$0
7V loden +\$0
7W napa +\$0
7Y sedona +\$0
7Z mink +\$0
8T gull +\$0
8Y moonbeam +\$0
B4 blue medium +\$0
ZK cappuccino +\$0

Bright Sand Texture Paint

For textured paint on smooth steel (XS)

91 white +\$0
CL cool grey neutral +\$0
G1 graphite +\$0
WN warm grey neutral +\$0

Step 7. Pull Type

1P smooth paint +\$0
1T textured paint +\$0
1S stained +\$0

Step 8. Pull Finish

For smooth paint (1P)

Nonmetallic Paint +\$0
 Metallic Paint +\$5

Sand Texture Paint

For textured paint (1T)

7L dune +\$0
7M chai +\$0
7N grass +\$0
7U blue ridge +\$0
7V loden +\$0
7W napa +\$0
7Y sedona +\$0
7Z mink +\$0
8T gull +\$0
8Y moonbeam +\$0
B4 blue medium +\$0
ZK cappuccino +\$0

Contour-Pull Freestanding Lateral File *continued*

Bright Sand Texture Paint		
<i>For textured paint (1T)</i>		
91	white	+\$0
CL	cool grey neutral	+\$0
G1	graphite	+\$0
WN	warm grey neutral	+\$0

Recut Finish		
<i>For stained (1S)</i>		
RA	light ash A	+\$0
RK	mahogany dark A	+\$0
RM	mahogany A	+\$0

Wood Finish		
<i>For stained (1S)</i>		
V3	cherry A	+\$9
Z3	warm red cherry A	+\$9
Z5	maple A	+\$9
ED	aged cherry A	+\$12
EG	medium brown walnut A	+\$12
EK	medium red walnut A	+\$12
EY	light anigre A	+\$12
UL	natural maple A	+\$12
UQ	light cherry A	+\$12
UV	red cherry A	+\$12
UX	walnut on cherry A	+\$12

Step 9. Top		
NT	no top	+\$0
T1	1"-high painted metal top with squared edge	+\$0
T2	1 1/4"-high painted metal top with squared edge	+\$0
T3	1 1/4"-high painted metal top with radius edge	+\$55
TL	1 1/4"-high laminate top with vinyl edge	+\$63
TR	1 1/4"-high recut veneer top A	+\$132
J3	1 1/4"-high cathedral recut veneer top A	+\$135
TF	1 1/4"-high wood veneer top A	+\$137
T7	6 1/2"-high planter top	+\$177
D1	6 1/2"-high full dome, side-to-side	+\$242
H1	6 1/2"-high half dome, sloping left	+\$242
H2	6 1/2"-high half dome, sloping right	+\$242
TV1	1 1/8"-high wood veneer top and wood composite edge with oversail front A	+\$284
TC1	1" cushion top	+\$350
TC2	2" cushion top	+\$350

Step 10. Lock		
<i>For no top (NT), 1 1/4"-high laminate top with vinyl edge (TL), 6 1/2"-high planter top (T7), 6 1/2"-high full dome, side-to-side (D1), 6 1/2"-high half dome, sloping left (H1), 6 1/2"-high half dome, sloping right (H2), or 1 1/8"-high wood veneer top and wood composite edge with oversail front (TV1)</i>		
NL	no lock	-\$26

<i>For 1"-high painted metal top with squared edge (T1), 1 1/4"-high painted metal top with squared edge (T2), 1 1/4"-high painted metal top with radius edge (T3), 1 1/4"-high recut veneer top (TR), 1 1/4"-high cathedral recut veneer top (J3), 1 1/4"-high wood veneer top (TF), 1" cushion top (TC1), or 2" cushion top (TC2)</i>		
KA	keyed alike	+\$0
KC	keyed differently, chrome	+\$0
KD	keyed differently, black	+\$0

Step 11.		
Top Finish: Solid-Color Laminate		
<i>For 1 1/4"-high laminate top with vinyl edge (TL)</i>		
8Q	folkstone grey	+\$0
91	white	+\$0
CL	cool grey neutral	+\$0
HF	inner tone light	+\$0
HT	inner tone	+\$0
LT	light tone	+\$0
LU	soft white	+\$0
WL	sandstone	+\$0
WN	warm grey neutral	+\$0

Top Finish: Fiber Laminate		
<i>For 1 1/4"-high laminate top with vinyl edge (TL)</i>		
1X	vanilla	+\$0
2X	wheat	+\$0
3X	celery	+\$0
4X	coriander	+\$0
5X	chamomile	+\$0
6X	cinnamon	+\$0
7X	cardamom	+\$0
8X	kale	+\$0

Contour-Pull Freestanding Lateral

File *continued*

Top Finish: Frosted Laminate

For 1 1/4"-high laminate top with vinyl edge (TL)

J4	frosted light grey	+\$0
J5	frosted inner tone light	+\$0
J6	frosted slate grey	+\$0
J7	frosted medium tone	+\$0
J8	frosted black	+\$0

Top Finish: Wood-Grain Laminate

For 1 1/4"-high laminate top with vinyl edge (TL)

LA	light ash	+\$0
LM	mahogany	+\$0

Top Finish: Zephyr Laminate

For 1 1/4"-high laminate top with vinyl edge (TL)

D1	canyon	+\$0
DC	misted	+\$0
DF	twilight	+\$0
DQ	desert	+\$0

Veneer Top Finish

For 1 1/4"-high recut veneer top (TR)

RA	light ash A	+\$0
RK	mahogany dark A	+\$0
RM	mahogany A	+\$0

Veneer Top Finish

For 1 1/4"-high cathedral recut veneer top (J3)

DU	cathedral recut natural maple A	+\$0
HU	cathedral recut light anigre A	+\$0
JU	cathedral recut aged cherry A	+\$0
VU	cathedral recut light brown walnut A	+\$0
WU	cathedral recut walnut on cherry A	+\$0
XU	cathedral recut medium red cherry A	+\$0
ZU	cathedral recut chocolate brown sapele A	+\$0

Veneer Top Finish

For 1 1/4"-high wood veneer top (TF)

V3	cherry A	+\$21
Z3	warm red cherry A	+\$21
Z5	maple A	+\$21
2U	light brown walnut A	+\$28
3U	medium red cherry A	+\$28
6U	chocolate brown sapele A	+\$28
ED	aged cherry A	+\$28
EG	medium brown walnut A	+\$28
EK	medium red walnut A	+\$28
EY	light anigre A	+\$28
UL	natural maple A	+\$28
UQ	light cherry A	+\$28
UV	red cherry A	+\$28
UX	walnut on cherry A	+\$28

Veneer Top Finish

For 1 1/8"-high wood veneer top and wood composite edge with oversail front (TV1)

ED	aged cherry A	+\$28
EG	medium brown walnut A	+\$28
EK	medium red walnut A	+\$28
EY	light anigre A	+\$28
UL	natural maple A	+\$28
UQ	light cherry A	+\$28
UV	red cherry A	+\$28
UX	walnut on cherry A	+\$28

Step 12. Edge Finish

For 1 1/4"-high laminate top with vinyl edge (TL)

8Q	folkstone grey	+\$0
91	white	+\$0
BU	black umber	+\$0
CL	cool grey neutral	+\$0
CM	cinnamon	+\$0
CO	chamomile	+\$0
G2	graphite satin	+\$0
HF	inner tone light	+\$0
HT	inner tone	+\$0
LA	light ash	+\$0
LM	mahogany	+\$0
LU	soft white	+\$0
MT	medium tone	+\$0
SG	slate grey	+\$0
WL	sandstone	+\$0
WN	warm grey neutral	+\$0

Contour-Pull Freestanding Lateral File *continued*

Step 13. Cushion Top Fabric

For 1" cushion top (TC1) or 2" cushion top (TC2)

See textiles list for fabric numbers. First 2 digits of number indicate fabric line; remaining digit(s) indicate fabric color.

Price Category 1	+\$0
Price Category 2	+\$55
Price Category 3	+\$67
Price Category 4	+\$82
Price Category 7	+\$137
Price Category 9	+\$950
Price Category B	+\$56
Price Category E	+\$139
Price Category G	+\$250
Price Category H	+\$333

Step 14. Base Height

B1	1"-high base	+\$0
B2	1½"-high base	+\$0
B3	2¼"-high base	+\$0
B4	3¼"-high base	+\$0
BA	1"-high recessed base	+\$32
BB	1½"-high recessed base	+\$32
BC	2¼"-high recessed base	+\$32
BD	3¼"-high recessed base	+\$32
B5	4¼"-high base	+\$32

Step 15. Counterweight

NO	no counterweight (must gang or anchor)	+\$0
CB	counterweight (recommended)	+\$115

Step 16. Drawer Interior

9M	3 dividers	+\$0
9P	front-to-back filing rail	+\$0
9R	side-to-side filing rail	+\$0

Ellipse-Pull Freestanding Lateral File

2J-30
2J-36
2J-42

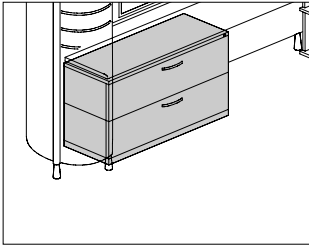

Product Information

Description

This lateral file holds letter-, legal-, and A4-size hanging files. It has ellipse pulls and smooth steel. The file has no top or a metal, cushion, laminate, planter, or veneer top. A positive interlock system permits only 1 drawer to open at a time. 1 lock controls all drawers. The drawers can be specified with 3 dividers or with front-to-back or side-to-side filing rails for hanging files. 5 base heights are available; all bases include adjustable glides.

Actual lateral file widths are 29⁷/₈" , 35⁷/₈" , or 41⁷/₈" ; actual depths are 17⁷/₈" or 19⁷/₈" .

Notes

For 2- or 3-high files that are not ganged or anchored, counterweights (option CB) are required. For 4- or 5-high files that are not ganged or anchored, counterweights are recommended.

Dimensional illustrations do not include all possible configurations.

To convert filing direction, order 1 of the following products separately:

- Front-to-back rail (9P002)
- Side-to-side rail (9R130)

Order optional file drawer organizer (LG901) separately.

For work surface on top of 1 or more lateral files, order file top (TPL or TPV) separately.

No lock option (NL) can only be specified on files with no top (NT), dome tops (D1, H1, or H2), planter top (T7), or laminate tops (TL). The (NL) option cannot be specified for configurations 4W and 4Z; these configurations always have a lock.

For configurations 4W and 4Z, a 1" filler top is included between the overhead storage and the drawers.

For cushion tops TC1 and TC2, a 1" metal top is included.

Cushion top accepts Customer's Own Material (COM). Yardage is estimated for nondirectional, 54"-wide fabrics. When ordering more than 1 cushion, round up total yardage requirement to next whole yard of fabric.

Width—Yardage

30"—1.05

36"—1.22

42"—1.40

For information on multiple quantities or directional fabrics, contact COM Department. See Order Information in Appendices.

For keyed-alike locks, order lock plugs separately. See Keyed-Alike Information in Appendices.

Dimensions

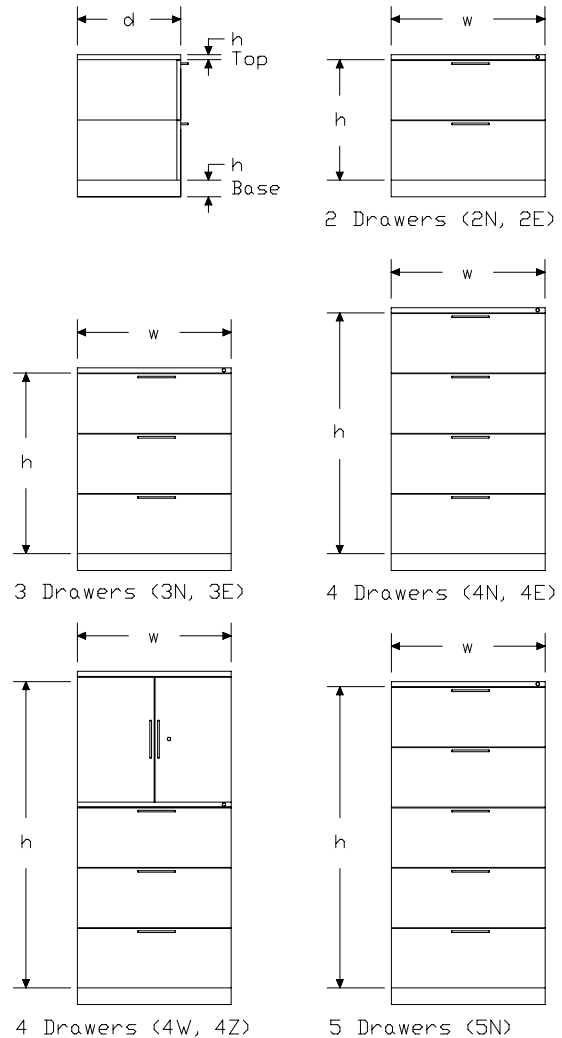

h	N	E	W	Z
2	23 1/2	26 1/4	-	-
3	35 1/4	39 3/8	-	-
4	47	52 1/2	62 1/2	66 5/8
5	58 3/4	-	-	-

All dimensions are in inches.

Ellipse-Pull Freestanding Lateral File *continued*

Specification Information

Step 1.

2J- A

Step 2. Width

30 30" wide A

36 36" wide A

42 42" wide A

Step 3. Depth

18- 18" deep A

20- 20" deep A

Step 4. Configuration

2N 2 11³/₄"-high drawers A

3N 3 11³/₄"-high drawers A

4N 4 11³/₄"-high drawers A

4W 1 26¹/₄"-high overhead storage, 3 11³/₄"-high drawers A

5N 5 11³/₄"-high drawers A

2E 2 13¹/₈"-high drawers A

3E 3 13¹/₈"-high drawers A

4E 4 13¹/₈"-high drawers A

4Z 1 26¹/₄"-high overhead storage, 3 13¹/₈"-high drawers A

Prices for Steps 1-4.

		2N	3N	4N	4W	5N	2E	3E		
2J-30	18-	\$775	1082	1388	1714	1693	775	1082		
	20-	\$775	1082	1388	1714	1693	775	1082		
2J-36	18-	\$862	1195	1530	1912	1863	862	1195		
	20-	\$862	1195	1530	1912	1863	862	1195		
2J-42	18-	\$976	1352	1729	2163	2108	976	1352		
	20-	\$976	1352	1729	2163	2108	976	1352		
									4E	4Z
2J-30	18-						\$1388	1714		
	20-						\$1388	1714		
2J-36	18-						\$1530	1912		
	20-						\$1530	1912		
2J-42	18-						\$1729	2163		
	20-						\$1729	2163		

Step 5. Paint/Steel Type

SS smooth paint on smooth steel A +\$0

TS smooth paint on textured steel A +\$0

XS textured paint on smooth steel A +\$0

Step 6. Case Finish

For smooth paint on smooth steel (SS) or smooth paint on textured steel (TS)

Nonmetallic Paint +\$0

Metallic Paint +\$65

Sand Texture Paint

For textured paint on smooth steel (XS)

7L dune A +\$0

7M chai A +\$0

7N grass A +\$0

7U blue ridge A +\$0

7V loden A +\$0

7W napa A +\$0

7Y sedona A +\$0

7Z mink A +\$0

8T gull A +\$0

8Y moonbeam A +\$0

B4 blue medium A +\$0

ZK cappuccino A +\$0

Bright Sand Texture Paint

For textured paint on smooth steel (XS)

91 white A +\$0

CL cool grey neutral A +\$0

G1 graphite A +\$0

WN warm grey neutral A +\$0

Step 7. Front Finish

For smooth paint on smooth steel (SS) or smooth paint on textured steel (TS)

Nonmetallic Paint +\$0

Metallic Paint +\$0

Ellipse-Pull Freestanding Lateral File *continued*

Sand Texture Paint		
<i>For textured paint on smooth steel (XS)</i>		
7L	dune <input type="checkbox"/>	+\$0
7M	chai <input type="checkbox"/>	+\$0
7N	grass <input type="checkbox"/>	+\$0
7U	blue ridge <input type="checkbox"/>	+\$0
7V	loden <input type="checkbox"/>	+\$0
7W	napa <input type="checkbox"/>	+\$0
7Y	sedona <input type="checkbox"/>	+\$0
7Z	mink <input type="checkbox"/>	+\$0
8T	gull <input type="checkbox"/>	+\$0
8Y	moonbeam <input type="checkbox"/>	+\$0
B4	blue medium <input type="checkbox"/>	+\$0
ZK	cappuccino <input type="checkbox"/>	+\$0

Bright Sand Texture Paint		
<i>For textured paint on smooth steel (XS)</i>		
91	white <input type="checkbox"/>	+\$0
CL	cool grey neutral <input type="checkbox"/>	+\$0
G1	graphite <input type="checkbox"/>	+\$0
WN	warm grey neutral <input type="checkbox"/>	+\$0

Step 8. Top		
NT	no top <input type="checkbox"/>	+\$0
T1	1"-high painted metal top with squared edge <input type="checkbox"/>	+\$0
T2	1 1/4"-high painted metal top with squared edge <input type="checkbox"/>	+\$0
T3	1 1/4"-high painted metal top with radius edge <input type="checkbox"/>	+\$55
TL	1 1/4"-high laminate top with vinyl edge <input type="checkbox"/>	+\$63
TR	1 1/4"-high recut veneer top <input type="checkbox"/>	+\$132
J3	1 1/4"-high cathedral recut veneer top <input type="checkbox"/>	+\$135
TF	1 1/4"-high wood veneer top <input type="checkbox"/>	+\$137
T7	6 1/2"-high planter top <input type="checkbox"/>	+\$177
D1	6 1/2"-high full dome, side-to-side <input type="checkbox"/>	+\$242
H1	6 1/2"-high half dome, sloping left <input type="checkbox"/>	+\$242
H2	6 1/2"-high half dome, sloping right <input type="checkbox"/>	+\$242
TV1	1 1/8"-high wood veneer top and wood composite edge with oversail front <input type="checkbox"/>	+\$284
TC1	1" cushion top <input type="checkbox"/>	+\$350
TC2	2" cushion top <input type="checkbox"/>	+\$350

Step 9. Lock		
<i>For 1 26 1/4"-high overhead storage, 3 11 3/4"-high drawers (4W) or 1 26 1/4"-high overhead storage, 3 13 1/8"-high drawers (4Z)</i>		
KA	keyed alike <input type="checkbox"/>	+\$0
KC	keyed differently, chrome <input type="checkbox"/>	+\$0
KD	keyed differently, black <input type="checkbox"/>	+\$0

<i>For configurations 2N, 2E, 3N, 3E, 4N, 4E, 5N with a top choice of no top (NT), laminate top (TL), dome top (D1, H1, H2), planter top (T7), or veneer top (TV1)</i>		
NL	no lock <input type="checkbox"/>	-\$26

<i>For configurations 2N, 2E, 3N, 3E, 4N, 4E, 5N with a top choice of painted metal top (T1, T2, T3), veneer top (J3, TF, TR), or cushion top (TC1, TC2)</i>		
KA	keyed alike <input type="checkbox"/>	+\$0
KC	keyed differently, chrome <input type="checkbox"/>	+\$0
KD	keyed differently, black <input type="checkbox"/>	+\$0

Step 10.

Top Finish: Solid-Color Laminate		
<i>For 1 1/4"-high laminate top with vinyl edge (TL)</i>		
8Q	folkstone grey <input type="checkbox"/>	+\$0
91	white <input type="checkbox"/>	+\$0
CL	cool grey neutral <input type="checkbox"/>	+\$0
HF	inner tone light <input type="checkbox"/>	+\$0
HT	inner tone <input type="checkbox"/>	+\$0
LT	light tone <input type="checkbox"/>	+\$0
LU	soft white <input type="checkbox"/>	+\$0
WL	sandstone <input type="checkbox"/>	+\$0
WN	warm grey neutral <input type="checkbox"/>	+\$0

Top Finish: Fiber Laminate		
<i>For 1 1/4"-high laminate top with vinyl edge (TL)</i>		
1X	vanilla <input type="checkbox"/>	+\$0
2X	wheat <input type="checkbox"/>	+\$0
3X	celery <input type="checkbox"/>	+\$0
4X	coriander <input type="checkbox"/>	+\$0
5X	chamomile <input type="checkbox"/>	+\$0
6X	cinnamon <input type="checkbox"/>	+\$0
7X	cardamom <input type="checkbox"/>	+\$0
8X	kale <input type="checkbox"/>	+\$0

Top Finish: Frosted Laminate		
<i>For 1 1/4"-high laminate top with vinyl edge (TL)</i>		
J4	frosted light grey <input type="checkbox"/>	+\$0
J5	frosted inner tone light <input type="checkbox"/>	+\$0
J6	frosted slate grey <input type="checkbox"/>	+\$0
J7	frosted medium tone <input type="checkbox"/>	+\$0
J8	frosted black <input type="checkbox"/>	+\$0

Ellipse-Pull Freestanding Lateral
File *continued*

Top Finish: Wood-Grain Laminate		
<i>For 1 1/4"-high laminate top with vinyl edge (TL)</i>		
LA	light ash <input type="checkbox"/>	+\$0
LM	mahogany <input type="checkbox"/>	+\$0

Top Finish: Zephyr Laminate		
<i>For 1 1/4"-high laminate top with vinyl edge (TL)</i>		
D1	canyon <input type="checkbox"/>	+\$0
DC	misted <input type="checkbox"/>	+\$0
DF	twilight <input type="checkbox"/>	+\$0
DQ	desert <input type="checkbox"/>	+\$0

Veneer Top Finish: Recut Veneer		
<i>For 1 1/4"-high recut veneer top (TR)</i>		
RA	light ash <input type="checkbox"/>	+\$0
RK	mahogany dark <input type="checkbox"/>	+\$0
RM	mahogany <input type="checkbox"/>	+\$0

Veneer Top Finish: Recut Veneer		
<i>For 1 1/4"-high cathedral recut veneer top (J3)</i>		
DU	cathedral recut natural maple <input type="checkbox"/>	+\$0
HU	cathedral recut light anigre <input type="checkbox"/>	+\$0
JU	cathedral recut aged cherry <input type="checkbox"/>	+\$0
VU	cathedral recut light brown walnut <input type="checkbox"/>	+\$0
WU	cathedral recut walnut on cherry <input type="checkbox"/>	+\$0
XU	cathedral recut medium red cherry <input type="checkbox"/>	+\$0
ZU	cathedral recut chocolate brown sapele <input type="checkbox"/>	+\$0

Veneer Top Finish: Wood Veneer		
<i>For 1 1/4"-high wood veneer top (TF)</i>		
V3	cherry <input type="checkbox"/>	+\$21
Z3	warm red cherry <input type="checkbox"/>	+\$21
Z5	maple <input type="checkbox"/>	+\$21
2U	light brown walnut <input type="checkbox"/>	+\$28
3U	medium red cherry <input type="checkbox"/>	+\$28
6U	chocolate brown sapele <input type="checkbox"/>	+\$28
ED	aged cherry <input type="checkbox"/>	+\$28
EG	medium brown walnut <input type="checkbox"/>	+\$28
EK	medium red walnut <input type="checkbox"/>	+\$28
EY	light anigre <input type="checkbox"/>	+\$28
UL	natural maple <input type="checkbox"/>	+\$28
UQ	light cherry <input type="checkbox"/>	+\$28
UV	red cherry <input type="checkbox"/>	+\$28
UX	walnut on cherry <input type="checkbox"/>	+\$28

Veneer Top Finish: Wood Veneer		
<i>For 1 1/8"-high wood veneer top and wood composite edge with oversail front (TV1)</i>		
ED	aged cherry <input type="checkbox"/>	+\$28
EG	medium brown walnut <input type="checkbox"/>	+\$28
EK	medium red walnut <input type="checkbox"/>	+\$28
EY	light anigre <input type="checkbox"/>	+\$28
UL	natural maple <input type="checkbox"/>	+\$28
UQ	light cherry <input type="checkbox"/>	+\$28
UV	red cherry <input type="checkbox"/>	+\$28
UX	walnut on cherry <input type="checkbox"/>	+\$28

Step 11. Edge Finish		
<i>For 1 1/4"-high laminate top with vinyl edge (TL)</i>		
8Q	folkstone grey <input type="checkbox"/>	+\$0
91	white <input type="checkbox"/>	+\$0
BU	black umber <input type="checkbox"/>	+\$0
CL	cool grey neutral <input type="checkbox"/>	+\$0
CM	cinnamon <input type="checkbox"/>	+\$0
CO	chamomile <input type="checkbox"/>	+\$0
G2	graphite satin <input type="checkbox"/>	+\$0
HF	inner tone light <input type="checkbox"/>	+\$0
HT	inner tone <input type="checkbox"/>	+\$0
LA	light ash <input type="checkbox"/>	+\$0
LM	mahogany <input type="checkbox"/>	+\$0
LU	soft white <input type="checkbox"/>	+\$0
MT	medium tone <input type="checkbox"/>	+\$0
SG	slate grey <input type="checkbox"/>	+\$0
WL	sandstone <input type="checkbox"/>	+\$0
WN	warm grey neutral <input type="checkbox"/>	+\$0

Step 12. Cushion Top Fabric		
<i>For 1" cushion top (TC1) or 2" cushion top (TC2)</i>		
<i>See textiles list for fabric numbers. First 2 digits of number indicate fabric line; remaining digit(s) indicate fabric color.</i>		
Price Category 1		+\$0
Price Category 2		+\$55
Price Category 3		+\$67
Price Category 4		+\$82
Price Category 7		+\$137
Price Category 9		+\$950
Price Category B		+\$56
Price Category E		+\$139
Price Category G		+\$250
Price Category H		+\$333

Meridian® Freestanding Stackable™ Lateral Files

Ellipse-Pull Freestanding Lateral

File *continued*

Meridian® Freestanding Stackable™ Lateral Files

Step 13. Base Height

B1	1"-high base <input type="checkbox"/> A	+\$0
B2	1½"-high base <input type="checkbox"/> A	+\$0
B3	2¼"-high base <input type="checkbox"/> A	+\$0
B4	3¼"-high base <input type="checkbox"/> A	+\$0
BA	1"-high recessed base <input type="checkbox"/> A	+\$32
BB	1½"-high recessed base <input type="checkbox"/> A	+\$32
BC	2¼"-high recessed base <input type="checkbox"/> A	+\$32
BD	3¼"-high recessed base <input type="checkbox"/> A	+\$32
B5	4¼"-high base <input type="checkbox"/> A	+\$32

Step 14. Counterweight

NO	no counterweight (must gang or anchor) <input type="checkbox"/> A	+\$0
CB	counterweight (recommended) <input type="checkbox"/> A	+\$115

Step 15. Drawer Interior

9P	front-to-back filing rail <input type="checkbox"/> A	+\$0
9R	side-to-side filing rail <input type="checkbox"/> A	+\$0
9M	3 dividers <input type="checkbox"/> A	+\$0

Step 16. Overhead Interior

For 1 26¼"-high overhead storage, 3 11¾"-high drawers (4W) or 1 26¼"-high overhead storage, 3 13⅛"-high drawers (4Z)

NS0	no interior option <input type="checkbox"/> A	-\$32
NS1	1 shelf total <input type="checkbox"/> A	+\$0
NS2	2 shelves total <input type="checkbox"/> A	+\$32

Frontless Freestanding Lateral File

23-30
23-36
23-42

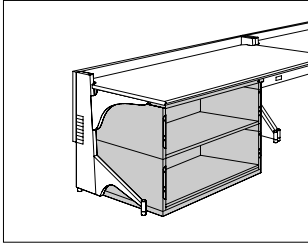

Product Information

Description

This lateral file holds letter-, legal-, and A4-size hanging files. It has smooth or textured steel and accepts customer's own fronts. The file has no top or a metal, laminate, planter, or veneer top. A positive interlock system permits only 1 drawer to open at a time. 1 lock controls all drawers. The drawers can be specified with 3 dividers or with front-to-back or side-to-side filing rails for hanging files. 5 base heights are available; all bases include adjustable glides.

Actual lateral file widths are 29⁷/₈" , 35⁷/₈" , or 41⁷/₈" ; actual depths are 17⁷/₈" or 19⁷/₈" .

Notes

For 2- or 3-high files that are not ganged or anchored, counterweights (option CB) are required. For 4- or 5-high files that are not ganged or anchored, counterweights are recommended.

Dimensional illustrations do not include all possible configurations.

To convert filing direction, order 1 of the following products separately:

- Front-to-back rail (9P002)
- Side-to-side rail (9R130)

Order optional file drawer organizer (LG901) separately.

For work surface on top of 1 or more lateral files, order file top (TPL or TPV) separately.

No lock option (NL) can only be specified on files with no top (NT), dome tops (D1, H1, or H2), planter top (T7), laminate tops (TL), or veneer top (TV1).

See Meridian Filing and Storage Technical Specifications for template to create customer's own fronts for frontless lateral file.

For cushion tops TC1 and TC2, a 1" metal top with lock is included.

Cushion top accepts Customer's Own Material (COM). Yardage is estimated for nondirectional, 54"-wide fabrics. When ordering more than 1 cushion, round up total yardage requirement to next whole yard of fabric.

Width—Yardage

30" —1.05

36" —1.22

42" —1.40

For information on multiple quantities or directional fabrics, contact COM Department. See Order Information in Appendices.

For keyed-alike locks, order lock plugs separately. See Keyed-Alike Information in Appendices.

Dimensions

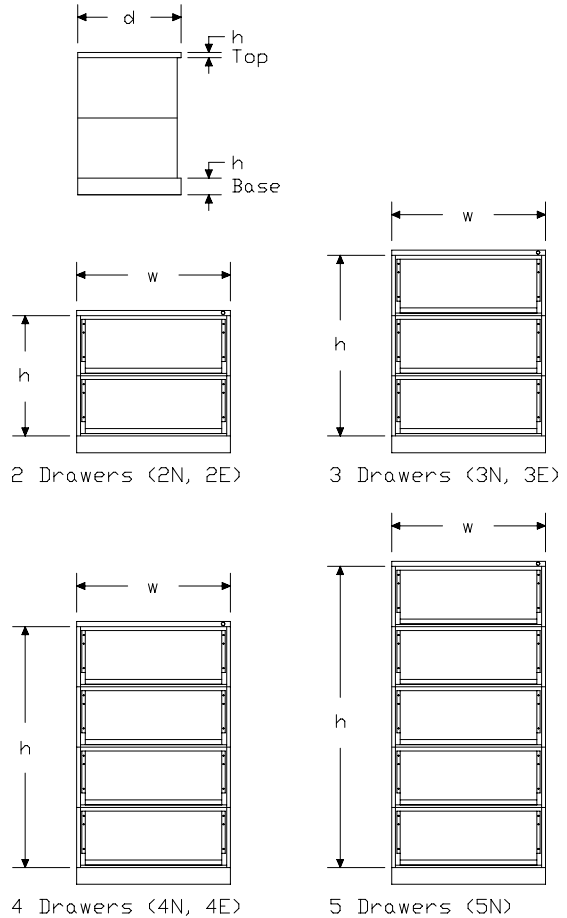

h	N	E
2	23 1/2	26 1/4
3	35 1/4	39 3/8
4	47	52 1/2
5	58 3/4	-

All dimensions are in inches.

Frontless Freestanding Lateral File

continued

Meridian® Freestanding Stackable™ Lateral Files

Specification Information

Step 1.

23-

Step 2. Width

30	30" wide
36	36" wide
42	42" wide

Step 3. Depth

18-	18" deep
20-	20" deep

Step 4. Configuration

2N	2 11 ³ / ₄ "-high drawers
3N	3 11 ³ / ₄ "-high drawers
4N	4 11 ³ / ₄ "-high drawers
5N	5 11 ³ / ₄ "-high drawers
2E	2 13 ¹ / ₈ "-high drawers
3E	3 13 ¹ / ₈ "-high drawers
4E	4 13 ¹ / ₈ "-high drawers

Prices for Steps 1-4.

		2N	3N	4N	5N	2E	3E	4E
23-30	18-	\$635	878	1122	1365	635	878	1122
	20-	\$635	878	1122	1365	635	878	1122
23-36	18-	\$709	975	1241	1507	709	975	1241
	20-	\$709	975	1241	1507	709	975	1241
23-42	18-	\$813	1117	1422	1727	813	1117	1422
	20-	\$813	1117	1422	1727	813	1117	1422

Step 5. Paint/Steel Type

SS	smooth paint on smooth steel	+\$0
TS	smooth paint on textured steel	+\$0
XS	textured paint on smooth steel	+\$0

Step 6. Surface Finish

For smooth paint on smooth steel (SS) or smooth paint on textured steel (TS)

Nonmetallic Paint	+\$0
Metallic Paint	+\$65

Sand Texture Paint

For textured paint on smooth steel (XS)

7L	dune	+\$0
7M	chai	+\$0
7N	grass	+\$0
7U	blue ridge	+\$0
7V	loden	+\$0
7W	napa	+\$0
7Y	sedona	+\$0
7Z	mink	+\$0
8T	gull	+\$0
8Y	moonbeam	+\$0
B4	blue medium	+\$0
ZK	cappuccino	+\$0

Bright Sand Texture Paint

For textured paint on smooth steel (XS)

91	white	+\$0
CL	cool grey neutral	+\$0
G1	graphite	+\$0
WN	warm grey neutral	+\$0

Step 7. Top

NT	no top	+\$0
T1	1"-high painted metal top with squared edge	+\$0
T2	1 ¹ / ₄ "-high painted metal top with squared edge	+\$0
T3	1 ¹ / ₄ "-high painted metal top with radius edge	+\$55
TA	1 ¹ / ₄ "-high metal top with recessed front edge	+\$55
TL	1 ¹ / ₄ "-high laminate top with vinyl edge	+\$63
TR	1 ¹ / ₄ "-high recut veneer top A	+\$132
J3	1 ¹ / ₄ "-high cathedral recut veneer top A	+\$135
TF	1 ¹ / ₄ "-high wood veneer top A	+\$137
T7	6 ¹ / ₂ "-high planter top	+\$177
D1	6 ¹ / ₂ "-high full dome, side-to-side	+\$242
H1	6 ¹ / ₂ "-high half dome, sloping left	+\$242
H2	6 ¹ / ₂ "-high half dome, sloping right	+\$242
TV1	1 ¹ / ₈ "-high wood veneer top and wood composite edge with oversail front A	+\$284
TC1	1" cushion top	+\$350
TC2	2" cushion top	+\$350

Frontless Freestanding Lateral File

continued

Step 8. Lock

For no top (NT), 1 1/4"-high laminate top with vinyl edge (TL), 6 1/2"-high planter top (T7), 6 1/2"-high full dome, side-to-side (D1), 6 1/2"-high half dome, sloping left (H1), 6 1/2"-high half dome, sloping right (H2), or 1 1/8"-high wood veneer top and wood composite edge with oversail front (TV1)

NL no lock -\$26

For 1"-high painted metal top with squared edge (T1), 1 1/4"-high painted metal top with squared edge (T2), 1 1/4"-high painted metal top with radius edge (T3), 1 1/4"-high metal top with recessed front edge (TA), 1 1/4"-high recut veneer top (TR), 1 1/4"-high cathedral recut veneer top (J3), 1 1/4"-high wood veneer top (TF), 1" cushion top (TC1), or 2" cushion top (TC2)

KA keyed alike +\$0
KC keyed differently, chrome +\$0
KD keyed differently, black +\$0

Step 9.

Top Finish: Solid-Color Laminate

For 1 1/4"-high laminate top with vinyl edge (TL)

8Q folkstone grey +\$0
91 white +\$0
CL cool grey neutral +\$0
HF inner tone light +\$0
HT inner tone +\$0
LT light tone +\$0
LU soft white +\$0
WL sandstone +\$0
WN warm grey neutral +\$0

Top Finish: Fiber Laminate

For 1 1/4"-high laminate top with vinyl edge (TL)

1X vanilla +\$0
2X wheat +\$0
3X celery +\$0
4X coriander +\$0
5X chamomile +\$0
6X cinnamon +\$0
7X cardamom +\$0
8X kale +\$0

Top Finish: Frosted Laminate

For 1 1/4"-high laminate top with vinyl edge (TL)

J4 frosted light grey +\$0
J5 frosted inner tone light +\$0
J6 frosted slate grey +\$0
J7 frosted medium tone +\$0
J8 frosted black +\$0

Top Finish: Wood-Grain Laminate

For 1 1/4"-high laminate top with vinyl edge (TL)

LA light ash +\$0
LM mahogany +\$0

Top Finish: Zephyr Laminate

For 1 1/4"-high laminate top with vinyl edge (TL)

D1 canyon +\$0
DC misted +\$0
DF twilight +\$0
DQ desert +\$0

Veneer Top Finish

For 1 1/4"-high recut veneer top (TR)

RA light ash +\$0
RK mahogany dark +\$0
RM mahogany +\$0

Veneer Top Finish

For 1 1/4"-high cathedral recut veneer top (J3)

DU cathedral recut natural maple +\$0
HU cathedral recut light anigre +\$0
JU cathedral recut aged cherry +\$0
VU cathedral recut light brown walnut +\$0
WU cathedral recut walnut on cherry +\$0
XU cathedral recut medium red cherry +\$0
ZU cathedral recut chocolate brown sapele +\$0

Frontless Freestanding Lateral File

continued

Veneer Top Finish

For 1¼"-high wood veneer top (TF)

V3	cherry <input type="checkbox"/>	+\$21
Z3	warm red cherry <input type="checkbox"/>	+\$21
Z5	maple <input type="checkbox"/>	+\$21
2U	light brown walnut <input type="checkbox"/>	+\$28
3U	medium red cherry <input type="checkbox"/>	+\$28
6U	chocolate brown sapele <input type="checkbox"/>	+\$28
ED	aged cherry <input type="checkbox"/>	+\$28
EG	medium brown walnut <input type="checkbox"/>	+\$28
EK	medium red walnut <input type="checkbox"/>	+\$28
EY	light anigre <input type="checkbox"/>	+\$28
UL	natural maple <input type="checkbox"/>	+\$28
UQ	light cherry <input type="checkbox"/>	+\$28
UV	red cherry <input type="checkbox"/>	+\$28
UX	walnut on cherry <input type="checkbox"/>	+\$28

Veneer Top Finish

For 1½"-high wood veneer top and wood composite edge with oversail front (TV1)

ED	aged cherry <input type="checkbox"/>	+\$28
EG	medium brown walnut <input type="checkbox"/>	+\$28
EK	medium red walnut <input type="checkbox"/>	+\$28
EY	light anigre <input type="checkbox"/>	+\$28
UL	natural maple <input type="checkbox"/>	+\$28
UQ	light cherry <input type="checkbox"/>	+\$28
UV	red cherry <input type="checkbox"/>	+\$28
UX	walnut on cherry <input type="checkbox"/>	+\$28

Step 10. Edge Finish

For 1¼"-high laminate top with vinyl edge (TL)

8Q	folkstone grey	+\$0
91	white	+\$0
BU	black umber	+\$0
CL	cool grey neutral	+\$0
CM	cinnamon	+\$0
CO	chamomile	+\$0
G2	graphite satin	+\$0
HF	inner tone light	+\$0
HT	inner tone	+\$0
LA	light ash	+\$0
LM	mahogany	+\$0
LU	soft white	+\$0
MT	medium tone	+\$0
SG	slate grey	+\$0
WL	sandstone	+\$0
WN	warm grey neutral	+\$0

Step 11. Cushion Top Fabric

For 1" cushion top (TC1) or 2" cushion top (TC2)

See textiles list for fabric numbers. First 2 digits of number indicate fabric line; remaining digit(s) indicate fabric color.

Price Category 1	+\$0
Price Category 2	+\$55
Price Category 3	+\$67
Price Category 4	+\$82
Price Category 7	+\$137
Price Category 9	+\$950
Price Category B	+\$56
Price Category E	+\$139
Price Category G	+\$250
Price Category H	+\$333

Step 12. Base Height

B1	1"-high base	+\$0
B2	1½"-high base	+\$0
B3	2¼"-high base	+\$0
B4	3¼"-high base	+\$0
BA	1"-high recessed base	+\$32
BB	1½"-high recessed base	+\$32
BC	2¼"-high recessed base	+\$32
BD	3¼"-high recessed base	+\$32
B5	4¼"-high base	+\$32

Step 13. Counterweight

NO	no counterweight (must gang or anchor)	+\$0
CB	counterweight (recommended)	+\$115

Step 14. Drawer Interior

9M	3 dividers	+\$0
9P	front-to-back filing rail	+\$0
9R	side-to-side filing rail	+\$0

Sloped-Pull Freestanding Lateral File

29P-3
29P-4
29V-3
29V-4

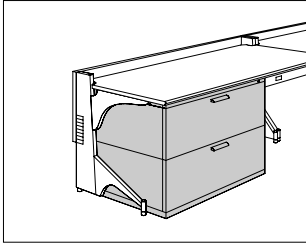

Product Information

Description

This lateral file holds letter-, legal-, and A4-size hanging files. It has sloped pulls and smooth or textured steel. The file has no top or a metal, cushion, laminate, planter, or veneer top. A positive interlock system permits only 1 drawer to open at a time. 1 lock controls all drawers. The drawers can be specified with 3 dividers or with front-to-back or side-to-side filing rails for hanging files. 5 base heights are available; all bases include adjustable glides.

Actual lateral file widths are 29⁷/₈" , 35⁷/₈" , or 41⁷/₈" ; actual depths are 17⁷/₈" or 19⁷/₈" .

Notes

For 2- or 3-high files that are not ganged or anchored, counterweights (option CB) are required. For 4- or 5-high files that are not ganged or anchored, counterweights are recommended.

Dimensional illustrations do not include all possible configurations.

To convert filing direction, order 1 of the following products separately:

- Front-to-back rail (9P002)
- Side-to-side rail (9R130)

Order optional file drawer organizer (LG901) separately.

For work surface on top of 1 or more lateral files, order file top (TPL or TPV) separately.

No lock option (NL) can only be specified on files with no top (NT), dome tops (D1, H1, or H2), planter top (T7), laminate tops (TL), or veneer top (TV1).

For cushion tops TC1 and TC2, a 1" metal top is included.

Grain direction is vertical for veneer-front lateral files.

Cushion top accepts Customer's Own Material (COM). Yardage is estimated for nondirectional, 54"-wide fabrics. When ordering more than 1 cushion, round up total yardage requirement to next whole yard of fabric.

Width—Yardage

30" —1.05

36" —1.22

42" —1.40

For information on multiple quantities or directional fabrics, contact COM Department. See Order Information in Appendices.

For keyed-alike locks, order lock plugs separately. See Keyed-Alike Information in Appendices.

Dimensions

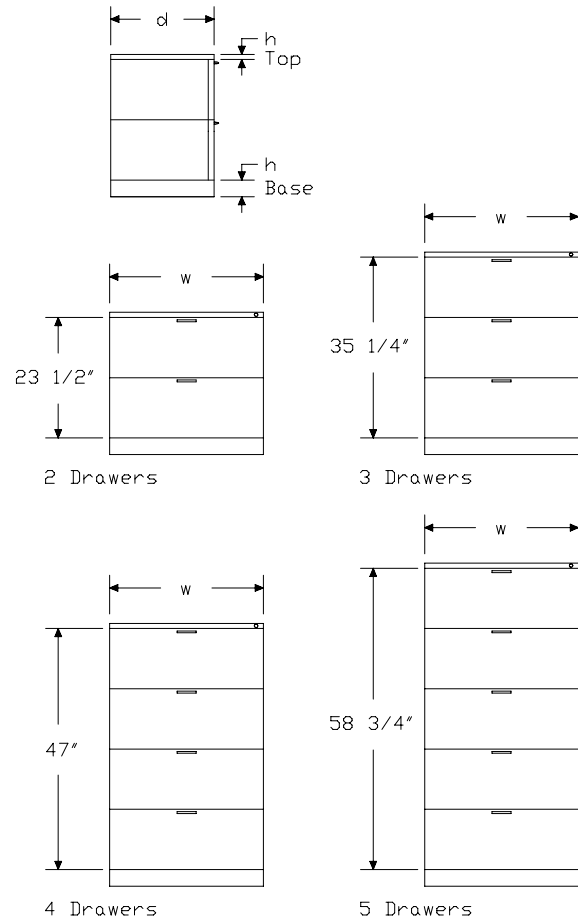

Meridian® Freestanding Stackable™ Lateral Files

Sloped-Pull Freestanding Lateral

File *continued*

Specification Information					
Step 1.					
29					
Step 2. Front Material					
P-	painted metal front				
V-	veneer front <input type="checkbox"/> A				
Step 3. Width					
30	30" wide				
36	36" wide				
42	42" wide				
Step 4. Depth					
18-	18" deep				
20-	20" deep				
Step 5. Configuration					
2N	2 drawers				
3N	3 drawers				
4N	4 drawers				
5N	5 drawers				
Prices for Steps 1-5.					
		2N	3N	4N	5N
29P-30	18-	\$706	983	1262	1540
	20-	\$706	983	1262	1540
29P-36	18-	\$784	1087	1391	1694
	20-	\$784	1087	1391	1694
29P-42	18-	\$888	1230	1572	1915
	20-	\$888	1230	1572	1915
29V-30	18-	\$996	1419	1842	2266
	20-	\$996	1419	1842	2266
29V-36	18-	\$1132	1609	2088	2565
	20-	\$1132	1609	2088	2565
29V-42	18-	\$1291	1835	2381	2924
	20-	\$1291	1835	2381	2924
Step 6. Paint/Steel Type					
SS	smooth paint on smooth steel				+\$0
TS	smooth paint on textured steel				+\$0
XS	textured paint on smooth steel				+\$0

Step 7. Surface Finish		
<i>For smooth paint on smooth steel (SS) or smooth paint on textured steel (TS)</i>		
Nonmetallic Paint	+\$0	
Metallic Paint	+\$65	
Sand Texture Paint		
<i>For textured paint on smooth steel (XS)</i>		
7L	dune	+\$0
7M	chai	+\$0
7N	grass	+\$0
7U	blue ridge	+\$0
7V	loden	+\$0
7W	napa	+\$0
7Y	sedona	+\$0
7Z	mink	+\$0
8T	gull	+\$0
8Y	moonbeam	+\$0
B4	blue medium	+\$0
ZK	cappuccino	+\$0
Bright Sand Texture Paint		
<i>For textured paint on smooth steel (XS)</i>		
91	white	+\$0
CL	cool grey neutral	+\$0
G1	graphite	+\$0
WN	warm grey neutral	+\$0

Sloped-Pull Freestanding Lateral File *continued*

Step 8. Top

For painted metal front (P-)

NT	no top	+\$0
T1	1"-high painted metal top with squared edge	+\$0
T2	1 1/4"-high painted metal top with squared edge	+\$0
T3	1 1/4"-high painted metal top with radius edge	+\$55
TL	1 1/4"-high laminate top with vinyl edge	+\$63
TR	1 1/4"-high recut veneer top A	+\$132
J3	1 1/4"-high cathedral recut veneer top A	+\$135
TF	1 1/4"-high wood veneer top A	+\$137
T7	6 1/2"-high planter top	+\$177
D1	6 1/2"-high full dome, side-to-side	+\$242
H1	6 1/2"-high half dome, sloping left	+\$242
H2	6 1/2"-high half dome, sloping right	+\$242
TV1	1 1/8"-high wood veneer top and wood composite edge with oversail front A	+\$284
TC1	1" cushion top	+\$350
TC2	2" cushion top	+\$350

For veneer front (V-)

NT	no top	+\$0
T1	1"-high painted metal top with squared edge	+\$0
T2	1 1/4"-high painted metal top with squared edge	+\$0
T3	1 1/4"-high painted metal top with radius edge	+\$55
TL	1 1/4"-high laminate top with vinyl edge	+\$63
J3	1 1/4"-high cathedral recut veneer top A	+\$135
TF	1 1/4"-high wood veneer top A	+\$137
T7	6 1/2"-high planter top	+\$177
D1	6 1/2"-high full dome, side-to-side	+\$242
H1	6 1/2"-high half dome, sloping left	+\$242
H2	6 1/2"-high half dome, sloping right	+\$242
TV1	1 1/8"-high wood veneer top and wood composite edge with oversail front A	+\$284
TC1	1" cushion top	+\$350
TC2	2" cushion top	+\$350

Step 9.

Veneer Top Finish: Wood Veneer

For painted metal front (P-) with 1 1/8"-high wood veneer top and wood composite edge with oversail front (TV1)

ED	aged cherry A	+\$28
EG	medium brown walnut A	+\$28
EK	medium red walnut A	+\$28
EY	light anigre A	+\$28
UL	natural maple A	+\$28
UQ	light cherry A	+\$28
UV	red cherry A	+\$28
UX	walnut on cherry A	+\$28

Veneer Top Finish: Recut Veneer

For painted metal front (P-) with 1 1/4"-high recut veneer top (TR)

RA	light ash A	+\$0
RK	mahogany dark A	+\$0
RM	mahogany A	+\$0

Veneer Top Finish: Recut Veneer

For painted metal front (P-) with 1 1/4"-high cathedral recut veneer top (J3)

DU	cathedral recut natural maple A	+\$0
HU	cathedral recut light anigre A	+\$0
JU	cathedral recut aged cherry A	+\$0
VU	cathedral recut light brown walnut A	+\$0
WU	cathedral recut walnut on cherry A	+\$0
XU	cathedral recut medium red cherry A	+\$0
ZU	cathedral recut chocolate brown sapele A	+\$0

Veneer Top Finish: Wood Veneer

For painted metal front (P-) with 1 1/4"-high wood veneer top (TF)

V3	cherry A	+\$21
Z3	warm red cherry A	+\$21
Z5	maple A	+\$21
2U	light brown walnut A	+\$28
3U	medium red cherry A	+\$28
6U	chocolate brown sapele A	+\$28
ED	aged cherry A	+\$28
EG	medium brown walnut A	+\$28
EK	medium red walnut A	+\$28
EY	light anigre A	+\$28
UL	natural maple A	+\$28
UQ	light cherry A	+\$28
UV	red cherry A	+\$28
UX	walnut on cherry A	+\$28

Sloped-Pull Freestanding Lateral

File *continued*

Veneer Front Finish: Recut Veneer

For veneer front (V-) with no top (NT), 1"-high painted metal top with squared edge (T1), 1 1/4"-high painted metal top with squared edge (T2), 1 1/4"-high painted metal top with radius edge (T3), 1 1/4"-high laminate top with vinyl edge (TL), 6 1/2"-high planter top (T7), 6 1/2"-high full dome, side-to-side (D1), 6 1/2"-high half dome, sloping left (H1), 6 1/2"-high half dome, sloping right (H2), 1" cushion top (TC1), or 2" cushion top (TC2)

DU	cathedral recut natural maple A	+\$0
HU	cathedral recut light anigre A	+\$0
JU	cathedral recut aged cherry A	+\$0
VU	cathedral recut light brown walnut A	+\$0
WU	cathedral recut walnut on cherry A	+\$0
XU	cathedral recut medium red cherry A	+\$0
ZU	cathedral recut chocolate brown sapele A	+\$0

Veneer Front Finish: Wood Veneer

For veneer front (V-) with no top (NT), 1"-high painted metal top with squared edge (T1), 1 1/4"-high painted metal top with squared edge (T2), 1 1/4"-high painted metal top with radius edge (T3), 1 1/4"-high laminate top with vinyl edge (TL), 6 1/2"-high planter top (T7), 6 1/2"-high full dome, side-to-side (D1), 6 1/2"-high half dome, sloping left (H1), 6 1/2"-high half dome, sloping right (H2), 1" cushion top (TC1), or 2" cushion top (TC2)

V3	cherry A	+\$42
Z3	warm red cherry A	+\$42
Z5	maple A	+\$42
2U	light brown walnut A	+\$56
3U	medium red cherry A	+\$56
6U	chocolate brown sapele A	+\$56
ED	aged cherry A	+\$56
EG	medium brown walnut A	+\$56
EK	medium red walnut A	+\$56
EY	light anigre A	+\$56
UL	natural maple A	+\$56
UQ	light cherry A	+\$56
UV	red cherry A	+\$56
UX	walnut on cherry A	+\$56

Veneer Front/Top Finish: Wood Veneer

For veneer front (V-) with 1 1/8"-high wood veneer top and wood composite edge with oversail front (TV1)

ED	aged cherry A	+\$56
EG	medium brown walnut A	+\$56
EK	medium red walnut A	+\$56
EY	light anigre A	+\$56
UL	natural maple A	+\$56
UQ	light cherry A	+\$56
UV	red cherry A	+\$56
UX	walnut on cherry A	+\$56

Veneer Front/Top Finish: Recut Veneer

For veneer front (V-) with 1 1/4"-high cathedral recut veneer top (J3)

DU	cathedral recut natural maple A	+\$0
HU	cathedral recut light anigre A	+\$0
JU	cathedral recut aged cherry A	+\$0
VU	cathedral recut light brown walnut A	+\$0
WU	cathedral recut walnut on cherry A	+\$0
XU	cathedral recut medium red cherry A	+\$0
ZU	cathedral recut chocolate brown sapele A	+\$0

Veneer Front/Top Finish: Wood Veneer

For veneer front (V-) with 1 1/4"-high wood veneer top (TF)

V3	cherry A	+\$42
Z3	warm red cherry A	+\$42
Z5	maple A	+\$42
2U	light brown walnut A	+\$56
3U	medium red cherry A	+\$56
6U	chocolate brown sapele A	+\$56
ED	aged cherry A	+\$56
EG	medium brown walnut A	+\$56
EK	medium red walnut A	+\$56
EY	light anigre A	+\$56
UL	natural maple A	+\$56
UQ	light cherry A	+\$56
UV	red cherry A	+\$56
UX	walnut on cherry A	+\$56

Sloped-Pull Freestanding Lateral File *continued*

Step 10. Top Finish

For 1 1/4"-high laminate top with vinyl edge (TL)

Solid-Color Laminate

8Q	folkstone grey	+\$0
91	white	+\$0
CL	cool grey neutral	+\$0
HF	inner tone light	+\$0
HT	inner tone	+\$0
LT	light tone	+\$0
LU	soft white	+\$0
WL	sandstone	+\$0
WN	warm grey neutral	+\$0

Fiber Laminate

1X	vanilla	+\$0
2X	wheat	+\$0
3X	celery	+\$0
4X	coriander	+\$0
5X	chamomile	+\$0
6X	cinnamon	+\$0
7X	cardamom	+\$0
8X	kale	+\$0

Frosted Laminate

J4	frosted light grey	+\$0
J5	frosted inner tone light	+\$0
J6	frosted slate grey	+\$0
J7	frosted medium tone	+\$0
J8	frosted black	+\$0

Wood-Grain Laminate

LA	light ash	+\$0
LM	mahogany	+\$0

Zephyr Laminate

D1	canyon	+\$0
DC	misted	+\$0
DF	twilight	+\$0
DQ	desert	+\$0

Step 11. Edge Finish

For 1 1/4"-high laminate top with vinyl edge (TL)

8Q	folkstone grey	+\$0
91	white	+\$0
BU	black umber	+\$0
CL	cool grey neutral	+\$0
CM	cinnamon	+\$0
CO	chamomile	+\$0
G2	graphite satin	+\$0
HF	inner tone light	+\$0
HT	inner tone	+\$0
LA	light ash	+\$0
LM	mahogany	+\$0
LU	soft white	+\$0
MT	medium tone	+\$0
SG	slate grey	+\$0
WL	sandstone	+\$0
WN	warm grey neutral	+\$0

Step 12. Cushion Top Fabric

For 1" cushion top (TC1) or 2" cushion top (TC2)

See textiles list for fabric numbers. First 2 digits of number indicate fabric line; remaining digit(s) indicate fabric color.

Price Category 1	+\$0
Price Category 2	+\$55
Price Category 3	+\$67
Price Category 4	+\$82
Price Category 7	+\$137
Price Category 9	+\$950
Price Category B	+\$56
Price Category E	+\$139
Price Category G	+\$250
Price Category H	+\$333

Step 13. Lock

For no top (NT), 1 1/4"-high laminate top with vinyl edge (TL), 6 1/2"-high planter top (T7), 6 1/2"-high full dome, side-to-side (D1), 6 1/2"-high half dome, sloping left (H1), 6 1/2"-high half dome, sloping right (H2), or 1 1/8"-high wood veneer top and wood composite edge with oversail front (TV1)

NL	no lock	-\$26
-----------	---------	-------

Sloped-Pull Freestanding Lateral

File *continued*

Meridian® Freestanding Stackable™ Lateral Files

For 1"-high painted metal top with squared edge (T1), 1/4"-high painted metal top with squared edge (T2), 1/4"-high painted metal top with radius edge (T3), 1/4"-high recut veneer top (TR), 1/4"-high cathedral recut veneer top (J3), 1/4"-high wood veneer top (TF), 1" cushion top (TC1), or 2" cushion top (TC2)

KA	keyed alike	+\$0
KC	keyed differently, chrome	+\$0
KD	keyed differently, black	+\$0

Step 14. Pull Finish

G2	graphite satin	+\$0
U1	brushed aluminum	+\$35
CS	brushed copper	+\$35

Step 15. Base Height

B1	1"-high base	+\$0
B2	1 1/2"-high base	+\$0
B3	2 1/4"-high base	+\$0
B4	3 1/4"-high base	+\$0
BA	1"-high recessed base	+\$32
BB	1 1/2"-high recessed base	+\$32
BC	2 1/4"-high recessed base	+\$32
BD	3 1/4"-high recessed base	+\$32
B5	4 1/4"-high base	+\$32

Step 16. Counterweight

NO	no counterweight (must gang or anchor)	+\$0
CB	counterweight (recommended)	+\$115

Step 17. Drawer Interior

9P	front-to-back filing rail	+\$0
9R	side-to-side filing rail	+\$0
9M	3 dividers	+\$0

Teneo™-Pull Freestanding Lateral File

2T-30
2T-36
2T-42

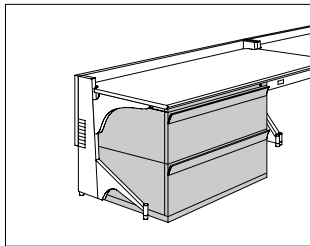

Product Information

Description

This lateral file has a smooth-steel case, painted front, and inset drawers with full-width Teneo™ pulls (painted to match case or anodized aluminum). The file has no top or a metal, cushion, laminate, planter, or veneer top. A positive interlock system permits only 1 drawer to open at a time. 1 lock secures all drawers. The drawers can be specified with 3 dividers or with front-to-back or side-to-side filing rails for hanging files. 5 base heights are available; all bases include adjustable glides. Actual lateral file widths are 29⁷/₈" , 35⁷/₈" , or 41⁷/₈" ; actual pull widths are 27⁵/₈" , 33⁵/₈" , or 39⁵/₈" ; actual depths are 17⁷/₈" or 19⁷/₈" .

Notes

For 2- or 3-high files that are not ganged or anchored, counterweights (option CB) are required. For 4- or 5-high files that are not ganged or anchored, counterweights are recommended.

Dimensional illustrations do not include all possible configurations.

To convert filing direction, order 1 of the following products separately:

- Front-to-back rail (9P002)
- Side-to-side rail (9R130)

Order optional file drawer organizer (LG901) separately.

For work surface on top of 1 or more lateral files, order file top (TPL or TPV) separately.

No lock option (NL) can only be specified on files with no top (NT), dome tops (D1, H1, or H2), planter top (T7), laminate tops (TL), or veneer top (TV1).

For cushion tops TC1 and TC2, a 1" metal top is included.

Cushion top accepts Customer's Own Material (COM). Yardage is estimated for nondirectional, 54"-wide fabrics. When ordering more than 1 cushion, round up total yardage requirement to next whole yard of fabric.

Width—Yardage

30" —1.05
36" —1.22
42" —1.40

For information on multiple quantities or directional fabrics, contact COM Department. See Order Information in Appendices.

For keyed-alike locks, order lock plugs separately. See Keyed-Alike Information in Appendices.

Dimensions

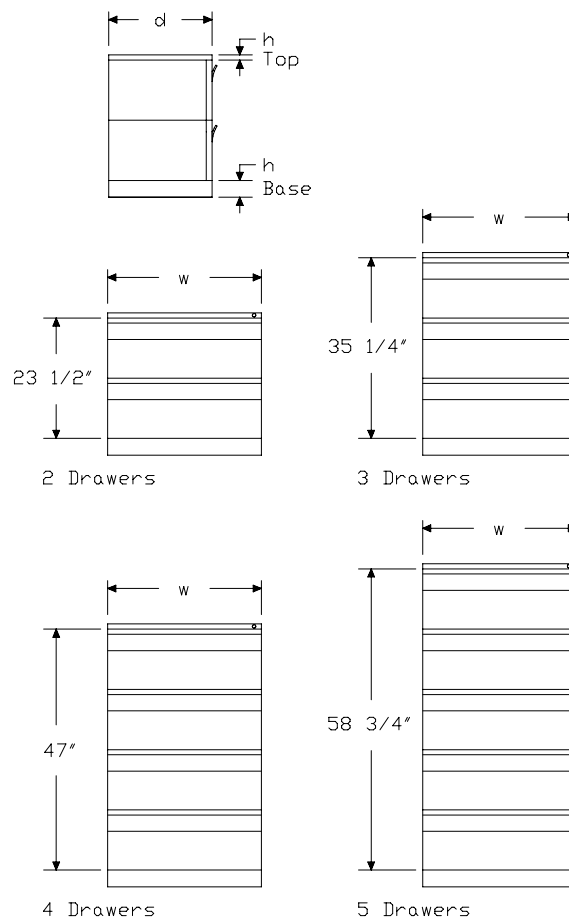

Teneo™-Pull Freestanding Lateral File *continued*

Specification Information

Step 1.

2T-

Step 2. Width

30	30" wide
36	36" wide
42	42" wide

Step 3. Depth

18-	18" deep
20-	20" deep

Step 4. Configuration

2N	2 11 ³ / ₄ "-high drawers
3N	3 11 ³ / ₄ "-high drawers
4N	4 11 ³ / ₄ "-high drawers
5N	5 11 ³ / ₄ "-high drawers

Prices for Steps 1-4.

		2N	3N	4N	5N
2T-30	18-	\$775	1082	1388	1693
	20-	\$775	1082	1388	1693
2T-36	18-	\$862	1195	1530	1863
	20-	\$862	1195	1530	1863
2T-42	18-	\$976	1352	1729	2108
	20-	\$976	1352	1729	2108

Step 5. Paint/Steel Type

SS	smooth paint on smooth steel	+\$0
XS	textured paint on smooth steel	+\$0

Step 6. Surface Finish

For smooth paint on smooth steel (SS)

8Q	folkstone grey	+\$0
91	white	+\$0
WL	sandstone	+\$0
CN	metallic champagne	+\$65
EH	metallic bronze	+\$65
MS	metallic silver	+\$65

Sand Texture Paint

For textured paint on smooth steel (XS)

7L	dune	+\$0
7M	chai	+\$0
7N	grass	+\$0
7U	blue ridge	+\$0
7V	loden	+\$0
7W	napa	+\$0
7Y	sedona	+\$0
7Z	mink	+\$0
8T	gull	+\$0
8Y	moonbeam	+\$0
B4	blue medium	+\$0
ZK	cappuccino	+\$0

Bright Sand Texture Paint

For textured paint on smooth steel (XS)

8Q	folkstone grey	+\$0
91	white	+\$0
CL	cool grey neutral	+\$0
G1	graphite	+\$0
WL	sandstone	+\$0
WN	warm grey neutral	+\$0

Step 7. Top

NT	no top	+\$0
T1	1"-high painted metal top with squared edge	+\$0
T2	1 ¹ / ₄ "-high painted metal top with squared edge	+\$0
T3	1 ¹ / ₄ "-high painted metal top with radius edge	+\$55
TL	1 ¹ / ₄ "-high laminate top with vinyl edge	+\$63
J3	1 ¹ / ₄ "-high cathedral recut veneer top	+\$135
TF	1 ¹ / ₄ "-high wood veneer top	+\$137
T7	6 ¹ / ₂ "-high planter top	+\$177
D1	6 ¹ / ₂ "-high full dome, side-to-side	+\$242
H1	6 ¹ / ₂ "-high half dome, sloping left	+\$242
H2	6 ¹ / ₂ "-high half dome, sloping right	+\$242
TC1	1" cushion top	+\$350
TC2	2" cushion top	+\$350

Step 8. Lock

KA	keyed alike	+\$0
KC	keyed differently, chrome	+\$0
KD	keyed differently, black	+\$0

Teneo™-Pull Freestanding Lateral File *continued*

Step 9.

Top Finish: Solid-Color Laminate

For 1 1/4"-high laminate top with vinyl edge (TL)

8Q	folkstone grey	+\$0
91	white	+\$0
CL	cool grey neutral	+\$0
LU	soft white	+\$0
WL	sandstone	+\$0
WN	warm grey neutral	+\$0

Top Finish: Zephyr Laminate

For 1 1/4"-high laminate top with vinyl edge (TL)

D1	canyon	+\$0
DC	misted	+\$0
DF	twilight	+\$0
DQ	desert	+\$0

Veneer Top Finish: Recut Veneer

For 1 1/4"-high cathedral recut veneer top (J3)

DU	cathedral recut natural maple	+\$0
HU	cathedral recut light anigre	+\$0
JU	cathedral recut aged cherry	+\$0
VU	cathedral recut light brown walnut	+\$0
WU	cathedral recut walnut on cherry	+\$0
XU	cathedral recut medium red cherry	+\$0
ZU	cathedral recut chocolate brown sapele	+\$0

Veneer Top Finish: Wood Veneer

For 1 1/4"-high wood veneer top (TF)

2U	light brown walnut	+\$28
3U	medium red cherry	+\$28
6U	chocolate brown sapele	+\$28
ED	aged cherry	+\$28
EY	light anigre	+\$28
UL	natural maple	+\$28
UX	walnut on cherry	+\$28

Step 10. Edge Finish

For 1 1/4"-high laminate top with vinyl edge (TL)

8Q	folkstone grey	+\$0
91	white	+\$0
CL	cool grey neutral	+\$0
G2	graphite satin	+\$0
LU	soft white	+\$0
WL	sandstone	+\$0
WN	warm grey neutral	+\$0

Step 11. Cushion Top Fabric

For 1" cushion top (TC1) or 2" cushion top (TC2)

Price Category 1	+\$0
Price Category 2	+\$55
Price Category 3	+\$67
Price Category 4	+\$82
Price Category 7	+\$137
Price Category B	+\$56
Price Category E	+\$139
Price Category G	+\$250
Price Category H	+\$333

Step 12. Pull Finish

P	painted to match case	+\$0
A	clear anodized aluminum pull	+\$50

Step 13. Base Height

B1	1"-high base	+\$0
B2	1 1/2"-high base	+\$0
B3	2 1/4"-high base	+\$0
B4	3 1/4"-high base	+\$0
BA	1"-high recessed base	+\$32
BB	1 1/2"-high recessed base	+\$32
BC	2 1/4"-high recessed base	+\$32
BD	3 1/4"-high recessed base	+\$32
B5	4 1/4"-high base	+\$32

Step 14. Counterweight

NO	no counterweight (must gang or anchor)	+\$0
CB	counterweight (recommended)	+\$115

Step 15. Drawer Interior

9P	front-to-back filing rail	+\$0
9R	side-to-side filing rail	+\$0
9M	3 dividers	+\$0

Lateral File Retrofit Cushion Top

TC1-3
 TC1-4
 TC2-3
 TC2-4

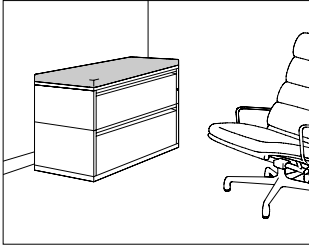

Meridian® Freestanding Stackable™ Lateral Files

Product Information

Description
 This cushion top is retrofit to a lateral file or storage case with a flat metal top. It is available in 2 heights, 3 widths, and 2 depths. Velcro strips are included to attach cushion to flat metal top.

Notes

Cushion top accepts Customer's Own Material (COM). Yardage is estimated for nondirectional, 54"-wide fabrics. When ordering more than 1 cushion, round up total yardage requirement to next whole yard of fabric.

Width—Yardage
 30"—1.05
 36"—1.22
 42"—1.40

For information on multiple quantities or directional fabrics, contact COM Department. See Order Information in Appendices.

Dimensions

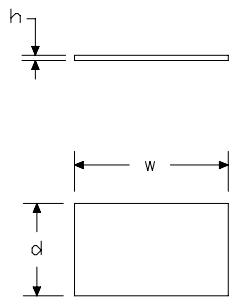

Specification Information

Step 1.

TC

Step 2. Height

- 1- 1" high
- 2- 2" high

Step 3. Width

- 30 30" wide
- 36 36" wide
- 42 42" wide

Step 4. Depth

- 18 18" deep
- 20 20" deep

Prices for Steps 1-4.

TC1-30	18	\$364
	20	\$364
TC1-36	18	\$364
	20	\$364
TC1-42	18	\$364
	20	\$364
TC2-30	18	\$364
	20	\$364
TC2-36	18	\$364
	20	\$364
TC2-42	18	\$364
	20	\$364

Lateral File Retrofit Cushion Top

continued

Step 5. Cushion Top Fabric

See textiles list for fabric numbers. First 2 digits of number indicate fabric line; remaining digit(s) indicate fabric color.

Price Category 1	+\$0
Price Category 2	+\$55
Price Category 3	+\$67
Price Category 4	+\$82
Price Category 7	+\$137
Price Category 9	+\$950
Price Category B	+\$56
Price Category E	+\$139
Price Category G	+\$250
Price Category H	+\$333

Standard-Pull Mobile Lateral File

M26-3
M26-4

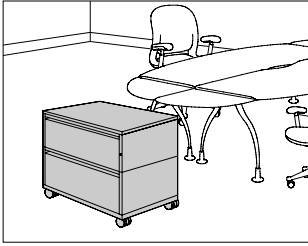

Meridian® Mobile Stackable™ Lateral Files

Product Information

Description

This lateral file holds letter-, legal-, and A4-size hanging files. It has standard pulls and smooth or textured steel. The file has a metal, cushion, laminate, planter, or veneer top. A positive interlock system permits only 1 drawer to open at a time. 1 lock controls all drawers. The drawers can be specified with 3 dividers or with front-to-back or side-to-side filing rails for hanging files. The 4^{3/4}"-high mobile base has a 1^{1/2}"-high base frame with 3^{1/4}"-high outset casters. The 2 swivel and 2 fixed casters must be field installed.

Actual lateral file widths are 29^{7/8}", 35^{7/8}", or 41^{7/8}"; actual depths are 17^{7/8}" or 19^{7/8}".

Notes

Dimensional illustrations do not include all possible configurations.

To convert filing direction, order 1 of the following products separately:

- Front-to-back rail (9P002)
- Side-to-side rail (9R130)

Order optional file drawer organizer (LG901) separately.

For cushion tops TC1 and TC2, a 1" metal top is included.

Cushion top accepts Customer's Own Material (COM). Yardage is estimated for nondirectional, 54"-wide fabrics. When ordering more than 1 cushion, round up total yardage requirement to next whole yard of fabric.

Width—Yardage

30"—1.05

36"—1.22

42"—1.40

For information on multiple quantities or directional fabrics, contact COM Department. See Order Information in Appendices.

For keyed-alike locks, order lock plugs separately. See Keyed-Alike Information in Appendices.

Dimensions

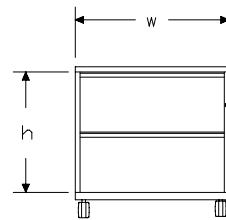
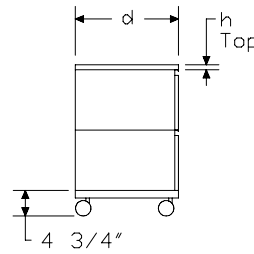

2 Drawers (2N, 2E)

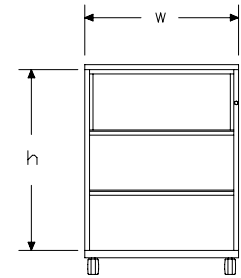

2 Drawers and Pass Through (KNN, KEE)

h	N	E	NN	EE
2	23 1/2	26 1/4	-	-
K	-	-	36 5/8	39 3/8

All dimensions are in inches.

Standard-Pull Mobile Lateral File

continued

Specification Information

Step 1.

M26-

Step 2. Width

30	30" wide
36	36" wide
42	42" wide

Step 3. Depth

18-	18" deep
20-	20" deep

Step 4. Configuration

2N	2 11 ³ / ₄ "-high drawers
2E	2 13 ¹ / ₈ "-high drawers
KNN	pass-through unit, 2 11 ³ / ₄ "-high drawers
KEE	pass-through unit, 2 13 ¹ / ₈ "-high drawers

Prices for Steps 1-4.

	2N	2E	KNN	KEE
M26-30 18-	\$1014	1014	1304	1304
20-	\$1014	1014	1304	1304
M26-36 18-	\$1103	1103	1414	1414
20-	\$1103	1103	1414	1414
M26-42 18-	\$1214	1214	1566	1566
20-	\$1214	1214	1566	1566

Step 5. Paint/Steel Type

SS	smooth paint on smooth steel	+\$0
TS	smooth paint on textured steel	+\$0
XS	textured paint on smooth steel	+\$0

Step 6. Surface Finish

For smooth paint on smooth steel (SS) or smooth paint on textured steel (TS)

Nonmetallic Paint	+\$0
Metallic Paint	+\$65

Sand Texture Paint

For textured paint on smooth steel (XS)

7L	dune	+\$0
7M	chai	+\$0
7N	grass	+\$0
7U	blue ridge	+\$0
7V	loden	+\$0
7W	napa	+\$0
7Y	sedona	+\$0
7Z	mink	+\$0
8T	gull	+\$0
8Y	moonbeam	+\$0
B4	blue medium	+\$0
ZK	cappuccino	+\$0

Bright Sand Texture Paint

For textured paint on smooth steel (XS)

91	white	+\$0
CL	cool grey neutral	+\$0
G1	graphite	+\$0
WN	warm grey neutral	+\$0

Step 7. Top

T1	1"-high painted metal top with squared edge	+\$0
T2	1 ¹ / ₄ "-high painted metal top with squared edge	+\$0
T3	1 ¹ / ₄ "-high painted metal top with radius edge	+\$55
TL	1 ¹ / ₄ "-high laminate top with vinyl edge	+\$63
TR	1 ¹ / ₄ "-high recut veneer top A	+\$132
J3	1 ¹ / ₄ "-high cathedral recut veneer top A	+\$135
TF	1 ¹ / ₄ "-high wood veneer top A	+\$137
T7	6 ¹ / ₂ "-high planter top	+\$177
D1	6 ¹ / ₂ "-high full dome, side-to-side	+\$242
H1	6 ¹ / ₂ "-high half dome, sloping left	+\$242
H2	6 ¹ / ₂ "-high half dome, sloping right	+\$242
TV1	1 ¹ / ₈ "-high wood veneer top and wood composite edge with oversail front A	+\$284
TC1	1" cushion top	+\$350
TC2	2" cushion top	+\$350

Meridian® Mobile Stackable™ Lateral Files

Standard-Pull Mobile Lateral File

continued

Meridian® Mobile Stackable™ Lateral Files

Step 8.

Top Finish: Solid-Color Laminate

For 1 1/4"-high laminate top with vinyl edge (TL)

8Q	folkstone grey	+\$0
91	white	+\$0
CL	cool grey neutral	+\$0
HF	inner tone light	+\$0
HT	inner tone	+\$0
LT	light tone	+\$0
LU	soft white	+\$0
WL	sandstone	+\$0
WN	warm grey neutral	+\$0

Top Finish: Fiber Laminate

For 1 1/4"-high laminate top with vinyl edge (TL)

1X	vanilla	+\$0
2X	wheat	+\$0
3X	celery	+\$0
4X	coriander	+\$0
5X	chamomile	+\$0
6X	cinnamon	+\$0
7X	cardamom	+\$0
8X	kale	+\$0

Top Finish: Frosted Laminate

For 1 1/4"-high laminate top with vinyl edge (TL)

J4	frosted light grey	+\$0
J5	frosted inner tone light	+\$0
J6	frosted slate grey	+\$0
J7	frosted medium tone	+\$0
J8	frosted black	+\$0

Top Finish: Wood-Grain Laminate

For 1 1/4"-high laminate top with vinyl edge (TL)

LA	light ash	+\$0
LM	mahogany	+\$0

Top Finish: Zephyr Laminate

For 1 1/4"-high laminate top with vinyl edge (TL)

D1	canyon	+\$0
DC	misted	+\$0
DF	twilight	+\$0
DQ	desert	+\$0

Veneer Top Finish

For 1 1/4"-high recut veneer top (TR)

RA	light ash <input type="checkbox"/>	+\$0
RK	mahogany dark <input type="checkbox"/>	+\$0
RM	mahogany <input type="checkbox"/>	+\$0

Veneer Top Finish

For 1 1/4"-high cathedral recut veneer top (J3)

DU	cathedral recut natural maple <input type="checkbox"/>	+\$0
HU	cathedral recut light anigre <input type="checkbox"/>	+\$0
JU	cathedral recut aged cherry <input type="checkbox"/>	+\$0
VU	cathedral recut light brown walnut <input type="checkbox"/>	+\$0
WU	cathedral recut walnut on cherry <input type="checkbox"/>	+\$0
XU	cathedral recut medium red cherry <input type="checkbox"/>	+\$0
ZU	cathedral recut chocolate brown sapele <input type="checkbox"/>	+\$0

Veneer Top Finish

For 1 1/4"-high wood veneer top (TF)

V3	cherry <input type="checkbox"/>	+\$21
Z3	warm red cherry <input type="checkbox"/>	+\$21
Z5	maple <input type="checkbox"/>	+\$21
2U	light brown walnut <input type="checkbox"/>	+\$28
3U	medium red cherry <input type="checkbox"/>	+\$28
6U	chocolate brown sapele <input type="checkbox"/>	+\$28
ED	aged cherry <input type="checkbox"/>	+\$28
EG	medium brown walnut <input type="checkbox"/>	+\$28
EK	medium red walnut <input type="checkbox"/>	+\$28
EY	light anigre <input type="checkbox"/>	+\$28
UL	natural maple <input type="checkbox"/>	+\$28
UQ	light cherry <input type="checkbox"/>	+\$28
UV	red cherry <input type="checkbox"/>	+\$28
UX	walnut on cherry <input type="checkbox"/>	+\$28

Veneer Top Finish

For 1 1/8"-high wood veneer top and wood composite edge with oversail front (TV1)

ED	aged cherry <input type="checkbox"/>	+\$28
EG	medium brown walnut <input type="checkbox"/>	+\$28
EK	medium red walnut <input type="checkbox"/>	+\$28
EY	light anigre <input type="checkbox"/>	+\$28
UL	natural maple <input type="checkbox"/>	+\$28
UQ	light cherry <input type="checkbox"/>	+\$28
UV	red cherry <input type="checkbox"/>	+\$28
UX	walnut on cherry <input type="checkbox"/>	+\$28

Standard-Pull Mobile Lateral File

continued

Step 9. Edge Finish

For 1¹/₄"-high laminate top with vinyl edge (TL)

8Q	folkstone grey	+\$0
91	white	+\$0
BU	black umber	+\$0
CL	cool grey neutral	+\$0
CM	cinnamon	+\$0
CO	chamomile	+\$0
G2	graphite satin	+\$0
HF	inner tone light	+\$0
HT	inner tone	+\$0
LA	light ash	+\$0
LM	mahogany	+\$0
LU	soft white	+\$0
MT	medium tone	+\$0
SG	slate grey	+\$0
WL	sandstone	+\$0
WN	warm grey neutral	+\$0

Step 10. Cushion Top Fabric

For 1" cushion top (TC1) or 2" cushion top (TC2)

See textiles list for fabric numbers. First 2 digits of number indicate fabric line; remaining digit(s) indicate fabric color.

Price Category 1	+\$0
Price Category 2	+\$55
Price Category 3	+\$67
Price Category 4	+\$82
Price Category 7	+\$137
Price Category 9	+\$950
Price Category B	+\$56
Price Category E	+\$139
Price Category G	+\$250
Price Category H	+\$333

Step 11. Lock

KA	keyed alike	+\$0
KC	keyed differently, chrome	+\$0
KD	keyed differently, black	+\$0

Step 12. Drawer Interior

9M	3 dividers	+\$0
9P	front-to-back filing rail	+\$0
9R	side-to-side filing rail	+\$0

Bevel-Pull Mobile Lateral File

M24-3
M24-4

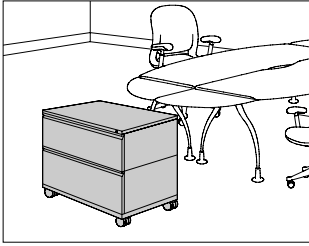

Meridian® Mobile Stackable™ Lateral Files

Product Information

Description

This lateral file holds letter-, legal-, and A4-size hanging files. It has bevel pulls and smooth or textured steel. The file has a metal, cushion, laminate, planter, or veneer top. A positive interlock system permits only 1 drawer to open at a time. 1 lock controls all drawers. The drawers can be specified with 3 dividers or with front-to-back or side-to-side filing rails for hanging files. The 4^{3/4}"-high mobile base has a 1^{1/2}"-high base frame with 3^{1/4}"-high outset casters. The 2 swivel and 2 fixed casters must be field installed.

Actual lateral file widths are 29^{7/8}", 35^{7/8}", or 41^{7/8}"; actual depths are 17^{7/8}" or 19^{7/8}".

Notes

Dimensional illustrations do not include all possible configurations.

To convert filing direction, order 1 of the following products separately:

- Front-to-back rail (gP002)
- Side-to-side rail (gR130)

Order optional file drawer organizer (LG901) separately.

For cushion tops TC1 and TC2, a 1" metal top is included.

Cushion top accepts Customer's Own Material (COM). Yardage is estimated for nondirectional, 54"-wide fabrics. When ordering more than 1 cushion, round up total yardage requirement to next whole yard of fabric.

Width—Yardage

30"—1.05

36"—1.22

42"—1.40

For information on multiple quantities or directional fabrics, contact COM Department. See Order Information in Appendices.

For keyed-alike locks, order lock plugs separately. See Keyed-Alike Information in Appendices.

Dimensions

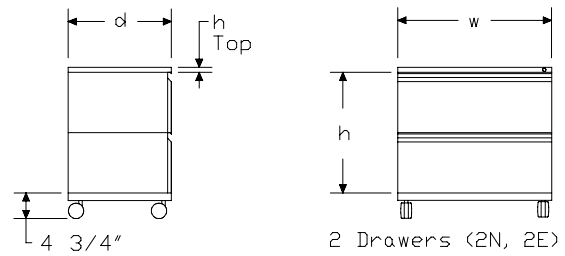

h	N	E
2	23 1/2	26 1/4

All dimensions are in inches.

Bevel-Pull Mobile Lateral File

continued

Meridian® Mobile Stackable™ Lateral Files

Specification Information

Step 1.

M24-

Step 2. Width

30	30" wide
36	36" wide
42	42" wide

Step 3. Depth

18-	18" deep
20-	20" deep

Step 4. Configuration

2N	2 11 ³ / ₄ "-high drawers
2E	2 13 ¹ / ₈ "-high drawers

Prices for Steps 1-4.

	2N	2E
M24-30 18-	\$1014	1014
20-	\$1014	1014
M24-36 18-	\$1103	1103
20-	\$1103	1103
M24-42 18-	\$1214	1214
20-	\$1214	1214

Step 5. Paint/Steel Type

SS	smooth paint on smooth steel	+ \$0
TS	smooth paint on textured steel	+ \$0
XS	textured paint on smooth steel	+ \$0

Step 6. Surface Finish

For smooth paint on smooth steel (SS) or smooth paint on textured steel (TS)

Nonmetallic Paint	+ \$0
Metallic Paint	+ \$65

Sand Texture Paint

For textured paint on smooth steel (XS)

7L	dune	+ \$0
7M	chai	+ \$0
7N	grass	+ \$0
7U	blue ridge	+ \$0
7V	loden	+ \$0
7W	napa	+ \$0
7Y	sedona	+ \$0
7Z	mink	+ \$0
8T	gull	+ \$0
8Y	moonbeam	+ \$0
B4	blue medium	+ \$0
ZK	cappuccino	+ \$0

Bright Sand Texture Paint

For textured paint on smooth steel (XS)

91	white	+ \$0
CL	cool grey neutral	+ \$0
G1	graphite	+ \$0
WN	warm grey neutral	+ \$0

Step 7. Top

T1	1"-high painted metal top with squared edge	+ \$0
T2	1 ¹ / ₄ "-high painted metal top with squared edge	+ \$0
T3	1 ¹ / ₄ "-high painted metal top with radius edge	+ \$55
TL	1 ¹ / ₄ "-high laminate top with vinyl edge	+ \$63
TR	1 ¹ / ₄ "-high recut veneer top A	+ \$132
J3	1 ¹ / ₄ "-high cathedral recut veneer top A	+ \$135
TF	1 ¹ / ₄ "-high wood veneer top A	+ \$137
T7	6 ¹ / ₂ "-high planter top	+ \$177
D1	6 ¹ / ₂ "-high full dome, side-to-side	+ \$242
H1	6 ¹ / ₂ "-high half dome, sloping left	+ \$242
H2	6 ¹ / ₂ "-high half dome, sloping right	+ \$242
TV1	1 ¹ / ₈ "-high wood veneer top and wood composite edge with oversail front A	+ \$284
TC1	1" cushion top	+ \$350
TC2	2" cushion top	+ \$350

Bevel-Pull Mobile Lateral File

continued

Meridian® Mobile Stackable™ Lateral Files

Step 8. Lock

For 1"-high painted metal top with squared edge (T1), 1/4"-high painted metal top with squared edge (T2), 1/4"-high painted metal top with radius edge (T3), 1/4"-high recut veneer top (TR), 1/4"-high cathedral recut veneer top (J3), 1/4"-high wood veneer top (TF), 1" cushion top (TC1), or 2" cushion top (TC2)

KA	keyed alike	+\$0
KC	keyed differently, chrome	+\$0
KD	keyed differently, black	+\$0

For 1/4"-high laminate top with vinyl edge (TL), 6 1/2"-high planter top (T7), 6 1/2"-high full dome, side-to-side (D1), 6 1/2"-high half dome, sloping left (H1), 6 1/2"-high half dome, sloping right (H2), or 1/8"-high wood veneer top and wood composite edge with oversail front (TV1)

NL	no lock	-\$26
-----------	---------	-------

Step 9.

Top Finish: Solid-Color Laminate

For 1/4"-high laminate top with vinyl edge (TL)

8Q	folkstone grey	+\$0
91	white	+\$0
CL	cool grey neutral	+\$0
HF	inner tone light	+\$0
HT	inner tone	+\$0
LT	light tone	+\$0
LU	soft white	+\$0
WL	sandstone	+\$0
WN	warm grey neutral	+\$0

Top Finish: Fiber Laminate

For 1/4"-high laminate top with vinyl edge (TL)

1X	vanilla	+\$0
2X	wheat	+\$0
3X	celery	+\$0
4X	coriander	+\$0
5X	chamomile	+\$0
6X	cinnamon	+\$0
7X	cardamom	+\$0
8X	kale	+\$0

Top Finish: Frosted Laminate

For 1/4"-high laminate top with vinyl edge (TL)

J4	frosted light grey	+\$0
J5	frosted inner tone light	+\$0
J6	frosted slate grey	+\$0
J7	frosted medium tone	+\$0
J8	frosted black	+\$0

Top Finish: Wood-Grain Laminate

For 1/4"-high laminate top with vinyl edge (TL)

LA	light ash	+\$0
LM	mahogany	+\$0

Top Finish: Zephyr Laminate

For 1/4"-high laminate top with vinyl edge (TL)

D1	canyon	+\$0
DC	misted	+\$0
DF	twilight	+\$0
DQ	desert	+\$0

Veneer Top Finish: Recut Veneer

For 1/4"-high recut veneer top (TR)

RA	light ash A	+\$0
RK	mahogany dark A	+\$0
RM	mahogany A	+\$0

Veneer Top Finish: Recut Veneer

For 1/4"-high cathedral recut veneer top (J3)

DU	cathedral recut natural maple A	+\$0
HU	cathedral recut light anigre A	+\$0
JU	cathedral recut aged cherry A	+\$0
VU	cathedral recut light brown walnut A	+\$0
WU	cathedral recut walnut on cherry A	+\$0
XU	cathedral recut medium red cherry A	+\$0
ZU	cathedral recut chocolate brown sapele A	+\$0

Bevel-Pull Mobile Lateral File

continued

Veneer Top Finish: Wood Veneer

For 1 1/4"-high wood veneer top (TF)

V3	cherry <input type="checkbox"/>	+\$21
Z3	warm red cherry <input type="checkbox"/>	+\$21
Z5	maple <input type="checkbox"/>	+\$21
2U	light brown walnut <input type="checkbox"/>	+\$28
3U	medium red cherry <input type="checkbox"/>	+\$28
6U	chocolate brown sapele <input type="checkbox"/>	+\$28
ED	aged cherry <input type="checkbox"/>	+\$28
EG	medium brown walnut <input type="checkbox"/>	+\$28
EK	medium red walnut <input type="checkbox"/>	+\$28
EY	light anigre <input type="checkbox"/>	+\$28
UL	natural maple <input type="checkbox"/>	+\$28
UQ	light cherry <input type="checkbox"/>	+\$28
UV	red cherry <input type="checkbox"/>	+\$28
UX	walnut on cherry <input type="checkbox"/>	+\$28

Veneer Top Finish: Wood Veneer

For 1 1/8"-high wood veneer top and wood composite edge with oversail front (TV1)

ED	aged cherry <input type="checkbox"/>	+\$28
EG	medium brown walnut <input type="checkbox"/>	+\$28
EK	medium red walnut <input type="checkbox"/>	+\$28
EY	light anigre <input type="checkbox"/>	+\$28
UL	natural maple <input type="checkbox"/>	+\$28
UQ	light cherry <input type="checkbox"/>	+\$28
UV	red cherry <input type="checkbox"/>	+\$28
UX	walnut on cherry <input type="checkbox"/>	+\$28

Step 10. Edge Finish

For 1 1/4"-high laminate top with vinyl edge (TL)

8Q	folkstone grey	+\$0
91	white	+\$0
BU	black umber	+\$0
CL	cool grey neutral	+\$0
CM	cinnamon	+\$0
CO	chamomile	+\$0
G2	graphite satin	+\$0
HF	inner tone light	+\$0
HT	inner tone	+\$0
LA	light ash	+\$0
LM	mahogany	+\$0
LU	soft white	+\$0
MT	medium tone	+\$0
SG	slate grey	+\$0
WL	sandstone	+\$0
WN	warm grey neutral	+\$0

Step 11. Cushion Top Fabric

For 1" cushion top (TC1) or 2" cushion top (TC2)

See textiles list for fabric numbers. First 2 digits of number indicate fabric line; remaining digit(s) indicate fabric color.

Price Category 1	+\$0
Price Category 2	+\$55
Price Category 3	+\$67
Price Category 4	+\$82
Price Category 7	+\$137
Price Category 9	+\$950
Price Category B	+\$56
Price Category E	+\$139
Price Category G	+\$250
Price Category H	+\$333

Step 12. Drawer Interior

9M	3 dividers	+\$0
9P	front-to-back filing rail	+\$0
9R	side-to-side filing rail	+\$0

Contour-Pull Mobile Lateral File

M25-3
M25-4

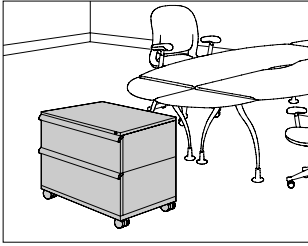

Meridian® Mobile Stackable™ Lateral Files

Product Information

Description

This lateral file holds letter-, legal-, and A4-size hanging files. It has stained wood or painted aluminum contour pulls and smooth or textured steel. The file has a metal, cushion, laminate, planter, or veneer top. A positive interlock system permits only 1 drawer to open at a time. 1 lock controls all drawers. The drawers can be specified with 3 dividers or with front-to-back or side-to-side filing rails for hanging files. The 4¾"-high mobile base has a 1½"-high base frame with ¾"-high outset casters. The 2 swivel and 2 fixed casters must be field installed. Actual lateral file widths are 29⅞", 35⅞", or 41⅞"; actual depths are 17⅞" or 19⅞".

Notes

Dimensional illustrations do not include all possible configurations.

To convert filing direction, order 1 of the following products separately:

- Front-to-back rail (gP002)
- Side-to-side rail (gR130)

Order optional file drawer organizer (LG901) separately.

For cushion tops TC1 and TC2, a 1" metal top is included.

Cushion top accepts Customer's Own Material (COM). Yardage is estimated for nondirectional, 54"-wide fabrics. When ordering more than 1 cushion, round up total yardage requirement to next whole yard of fabric.

Width—Yardage

30"—1.05

36"—1.22

42"—1.40

For information on multiple quantities or directional fabrics, contact COM Department. See Order Information in Appendices.

For keyed-alike locks, order lock plugs separately. See Keyed-Alike Information in Appendices.

Dimensions

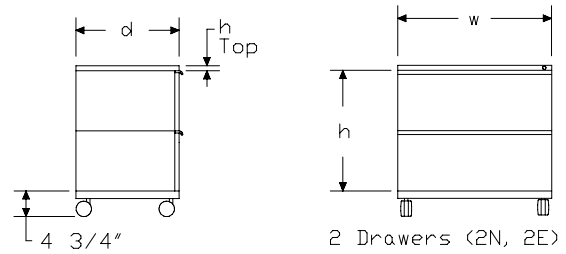

h	N	E
2	23 1/2	26 1/4

All dimensions are in inches.

Contour-Pull Mobile Lateral File

continued

Specification Information

Step 1.

M25-

Step 2. Width

30	30" wide
36	36" wide
42	42" wide

Step 3. Depth

18-	18" deep
20-	20" deep

Step 4. Configuration

2N	2 11 ³ / ₄ "-high drawers
2E	2 13 ¹ / ₈ "-high drawers

Prices for Steps 1-4.

	2N	2E
M25-30 18-	\$1151	1151
20-	\$1151	1151
M25-36 18-	\$1265	1265
20-	\$1265	1265
M25-42 18-	\$1409	1409
20-	\$1409	1409

Step 5. Paint/Steel Type

SS	smooth paint on smooth steel	+\$0
TS	smooth paint on textured steel	+\$0
XS	textured paint on smooth steel	+\$0

Step 6. Surface Finish

For smooth paint on smooth steel (SS) or smooth paint on textured steel (TS)

Nonmetallic Paint	+\$0
Metallic Paint	+\$65

Sand Texture Paint

For textured paint on smooth steel (XS)

7L	dune	+\$0
7M	chai	+\$0
7N	grass	+\$0
7U	blue ridge	+\$0
7V	loden	+\$0
7W	napa	+\$0
7Y	sedona	+\$0
7Z	mink	+\$0
8T	gull	+\$0
8Y	moonbeam	+\$0
B4	blue medium	+\$0
ZK	cappuccino	+\$0

Bright Sand Texture Paint

For textured paint on smooth steel (XS)

91	white	+\$0
CL	cool grey neutral	+\$0
G1	graphite	+\$0
WN	warm grey neutral	+\$0

Step 7. Pull Type

1P	smooth paint	+\$0
1T	textured paint	+\$0
1S	stained <input type="checkbox"/>	+\$0

Step 8. Pull Finish

For smooth paint (1P)

Nonmetallic Paint	+\$0
Metallic Paint	+\$5

Sand Texture Paint

For textured paint (1T)

7L	dune	+\$0
7M	chai	+\$0
7N	grass	+\$0
7U	blue ridge	+\$0
7V	loden	+\$0
7W	napa	+\$0
7Y	sedona	+\$0
7Z	mink	+\$0
8T	gull	+\$0
8Y	moonbeam	+\$0
B4	blue medium	+\$0
ZK	cappuccino	+\$0

Meridian® Mobile Stackable™ Lateral Files

Contour-Pull Mobile Lateral File

continued

Meridian® Mobile Stackable™ Lateral Files

Bright Sand Texture Paint

For textured paint (1T)

91	white	+\$0
CL	cool grey neutral	+\$0
G1	graphite	+\$0
WN	warm grey neutral	+\$0

Recut Finish

For stained (1S)

RA	light ash A	+\$0
RK	mahogany dark A	+\$0
RM	mahogany A	+\$0

Wood Finish

For stained (1S)

V3	cherry A	+\$9
Z3	warm red cherry A	+\$9
Z5	maple A	+\$9
ED	aged cherry A	+\$12
EG	medium brown walnut A	+\$12
EK	medium red walnut A	+\$12
EY	light anigre A	+\$12
UL	natural maple A	+\$12
UQ	light cherry A	+\$12
UV	red cherry A	+\$12
UX	walnut on cherry A	+\$12

Step 9. Top

T1	1"-high painted metal top with squared edge	+\$0
T2	1 1/4"-high painted metal top with squared edge	+\$0
T3	1 1/4"-high painted metal top with radius edge	+\$55
TL	1 1/4"-high laminate top with vinyl edge	+\$63
TR	1 1/4"-high recut veneer top A	+\$132
J3	1 1/4"-high cathedral recut veneer top A	+\$135
TF	1 1/4"-high wood veneer top A	+\$137
T7	6 1/2"-high planter top	+\$177
D1	6 1/2"-high full dome, side-to-side	+\$242
H1	6 1/2"-high half dome, sloping left	+\$242
H2	6 1/2"-high half dome, sloping right	+\$242
TV1	1 1/8"-high wood veneer top and wood composite edge with oversail front A	+\$284
TC1	1" cushion top	+\$350
TC2	2" cushion top	+\$350

Step 10. Lock

For 1"-high painted metal top with squared edge (T1), 1 1/4"-high painted metal top with squared edge (T2), 1 1/4"-high painted metal top with radius edge (T3), 1 1/4"-high recut veneer top (TR), 1 1/4"-high cathedral recut veneer top (J3), 1 1/4"-high wood veneer top (TF), 1" cushion top (TC1), or 2" cushion top (TC2)

KA	keyed alike	+\$0
KC	keyed differently, chrome	+\$0
KD	keyed differently, black	+\$0

For 1 1/4"-high laminate top with vinyl edge (TL), 6 1/2"-high planter top (T7), 6 1/2"-high full dome, side-to-side (D1), 6 1/2"-high half dome, sloping left (H1), 6 1/2"-high half dome, sloping right (H2), or 1 1/8"-high wood veneer top and wood composite edge with oversail front (TV1)

NL	no lock	-\$26
-----------	---------	-------

Step 11.

Top Finish: Solid-Color Laminate

For 1 1/4"-high laminate top with vinyl edge (TL)

8Q	folkstone grey	+\$0
91	white	+\$0
CL	cool grey neutral	+\$0
HF	inner tone light	+\$0
HT	inner tone	+\$0
LT	light tone	+\$0
LU	soft white	+\$0
WL	sandstone	+\$0
WN	warm grey neutral	+\$0

Top Finish: Fiber Laminate

For 1 1/4"-high laminate top with vinyl edge (TL)

1X	vanilla	+\$0
2X	wheat	+\$0
3X	celery	+\$0
4X	coriander	+\$0
5X	chamomile	+\$0
6X	cinnamon	+\$0
7X	cardamom	+\$0
8X	kale	+\$0

Contour-Pull Mobile Lateral File

continued

Top Finish: Frosted Laminate		
<i>For 1 1/4"-high laminate top with vinyl edge (TL)</i>		
J4	frosted light grey	+\$0
J5	frosted inner tone light	+\$0
J6	frosted slate grey	+\$0
J7	frosted medium tone	+\$0
J8	frosted black	+\$0

Top Finish: Wood-Grain Laminate		
<i>For 1 1/4"-high laminate top with vinyl edge (TL)</i>		
LA	light ash	+\$0
LM	mahogany	+\$0

Top Finish: Zephyr Laminate		
<i>For 1 1/4"-high laminate top with vinyl edge (TL)</i>		
D1	canyon	+\$0
DC	misted	+\$0
DF	twilight	+\$0
DQ	desert	+\$0

Veneer Top Finish		
<i>For 1 1/4"-high recut veneer top (TR)</i>		
RA	light ash <input type="checkbox"/>	+\$0
RK	mahogany dark <input type="checkbox"/>	+\$0
RM	mahogany <input type="checkbox"/>	+\$0

Veneer Top Finish		
<i>For 1 1/4"-high cathedral recut veneer top (J3)</i>		
DU	cathedral recut natural maple <input type="checkbox"/>	+\$0
HU	cathedral recut light anigre <input type="checkbox"/>	+\$0
JU	cathedral recut aged cherry <input type="checkbox"/>	+\$0
VU	cathedral recut light brown walnut <input type="checkbox"/>	+\$0
WU	cathedral recut walnut on cherry <input type="checkbox"/>	+\$0
XU	cathedral recut medium red cherry <input type="checkbox"/>	+\$0
ZU	cathedral recut chocolate brown sapele <input type="checkbox"/>	+\$0

Veneer Top Finish		
<i>For 1 1/4"-high wood veneer top (TF)</i>		
V3	cherry <input type="checkbox"/>	+\$21
Z3	warm red cherry <input type="checkbox"/>	+\$21
Z5	maple <input type="checkbox"/>	+\$21
2U	light brown walnut <input type="checkbox"/>	+\$28
3U	medium red cherry <input type="checkbox"/>	+\$28
6U	chocolate brown sapele <input type="checkbox"/>	+\$28
ED	aged cherry <input type="checkbox"/>	+\$28
EG	medium brown walnut <input type="checkbox"/>	+\$28
EK	medium red walnut <input type="checkbox"/>	+\$28
EY	light anigre <input type="checkbox"/>	+\$28
UL	natural maple <input type="checkbox"/>	+\$28
UQ	light cherry <input type="checkbox"/>	+\$28
UV	red cherry <input type="checkbox"/>	+\$28
UX	walnut on cherry <input type="checkbox"/>	+\$28

Veneer Top Finish		
<i>For 1 1/8"-high wood veneer top and wood composite edge with oversail front (TV1)</i>		
ED	aged cherry <input type="checkbox"/>	+\$28
EG	medium brown walnut <input type="checkbox"/>	+\$28
EK	medium red walnut <input type="checkbox"/>	+\$28
EY	light anigre <input type="checkbox"/>	+\$28
UL	natural maple <input type="checkbox"/>	+\$28
UQ	light cherry <input type="checkbox"/>	+\$28
UV	red cherry <input type="checkbox"/>	+\$28
UX	walnut on cherry <input type="checkbox"/>	+\$28

Step 12. Edge Finish		
<i>For 1 1/4"-high laminate top with vinyl edge (TL)</i>		
8Q	folkstone grey	+\$0
91	white	+\$0
BU	black umber	+\$0
CL	cool grey neutral	+\$0
CM	cinnamon	+\$0
CO	chamomile	+\$0
G2	graphite satin	+\$0
HF	inner tone light	+\$0
HT	inner tone	+\$0
LA	light ash	+\$0
LM	mahogany	+\$0
LU	soft white	+\$0
MT	medium tone	+\$0
SG	slate grey	+\$0
WL	sandstone	+\$0
WN	warm grey neutral	+\$0

Meridian® Mobile Stackable™ Lateral Files

Contour-Pull Mobile Lateral File

continued

Meridian® Mobile Stackable™ Lateral Files

Step 13. Cushion Top Fabric

For 1" cushion top (TC1) or 2" cushion top (TC2)

See textiles list for fabric numbers. First 2 digits of number indicate fabric line; remaining digit(s) indicate fabric color.

Price Category 1	+\$0
Price Category 2	+\$55
Price Category 3	+\$67
Price Category 4	+\$82
Price Category 7	+\$137
Price Category 9	+\$950
Price Category B	+\$56
Price Category E	+\$139
Price Category G	+\$250
Price Category H	+\$333

Step 14. Drawer Interior

9M	3 dividers	+\$0
9P	front-to-back filing rail	+\$0
9R	side-to-side filing rail	+\$0

Front-to-Back Filing Rail,
Meridian® Stackable™ Lateral File

9P001
9P002
9P361
9P362

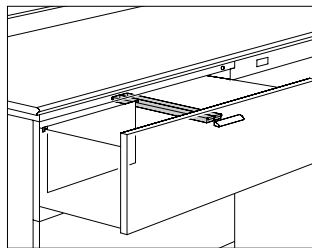

Product Information

Description

This filing rail holds letter-size hanging folders for front-to-back filing. The 16" rail is used in an 18"-deep Meridian® lateral file drawer. The 18" rail is used in the file drawer of a Meridian Stackable Storage™ cabinet bottom module, 20"-deep Meridian lateral file, or Meridian lateral storage tower.

Notes

Front-to-back filing rail cannot be used in Tu™ or Quadrant® lateral file drawers.

Dimensions

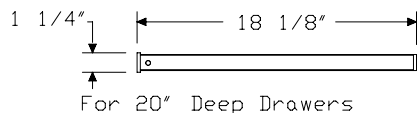
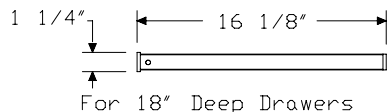
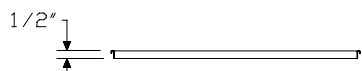

Specification Information

Step 1.

9P

Step 2. Width

00 for 30"- or 42"-wide drawers

36 for 36"-wide drawers

Step 3. Depth

18 18" deep

20 20" deep

Prices for Steps 1-3.

9P0018	\$24
9P0020	\$24
9P3618	\$24
9P3620	\$24

Side-to-Side Filing Rail, Meridian® Stackable™ Lateral File

- 9R124
- 9R130
- 9R136
- 9R142
- 9R224
- 9R230
- 9R236
- 9R242

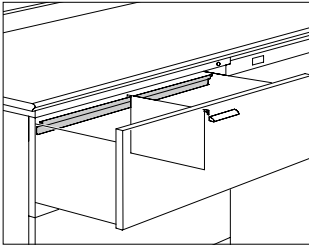

Meridian® Stackable™ Lateral File Accessories

Product Information

Description
 This filing rail holds letter- or legal-size hanging folders for side-to-side filing. The 21"-wide rail is used in the file drawer of a 24"-wide Meridian® Stackable Storage™ cabinet bottom module. The 27"-wide rail is used in the file drawer of a 30"-wide Meridian Stackable Storage cabinet bottom module, Meridian lateral file, or Meridian lateral storage tower. The 33"-wide rail is used in the file drawer of a 36"-wide Meridian lateral file. The 39"-wide rail is used in the file drawer of a 42"-wide Meridian lateral file.

Notes
 Side-to-side filing rail cannot be used in Tu™ or Quadrant® lateral file drawers.

Dimensions

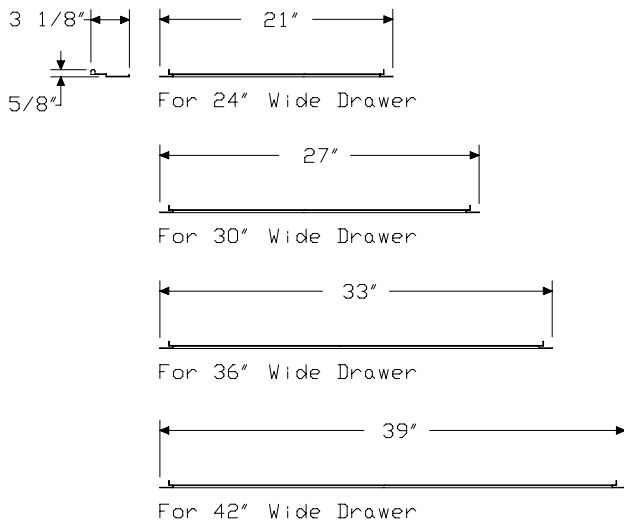

Specification Information

Step 1.

9R

Step 2. Quantity

- 1** 1 filing rail
- 2** 2 filing rails

Step 3. Width

- 2400** for 24"-wide drawers
- 3000** for 30"-wide drawers
- 3600** for 36"-wide drawers
- 4200** for 42"-wide drawers

Prices for Steps 1-3.

9R12400	\$17
9R13000	\$17
9R13600	\$17
9R14200	\$17
9R22400	\$34
9R23000	\$34
9R23600	\$34
9R24200	\$34

Movable Divider, Meridian®,
 Quadrant® or Tu™ Lateral File 9M100
 9M300

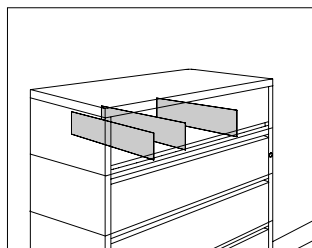

Product Information

Description

This adjustable metal divider fits into slots of an 18"- or 20"-deep Meridian® Stackable™ lateral file drawer. The 18"-deep divider also fits into a pullout shelf's slots on a Tu™ or Quadrant® 5-high lateral file. Finish is black umber.

Dimensions

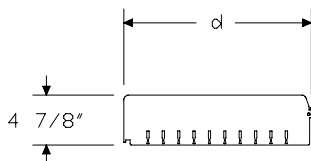

Specification Information

Step 1.

9M

Step 2. Quantity

- 100** 1 divider
- 300** 3 dividers

Step 3. Depth

- 18** for Meridian® 18" deep Stackable lateral file modules or Quadrant™ 20" deep flipper door with pullout shelf
- 20** for Meridian 20" deep Stackable lateral file modules

Prices for Steps 1-3.

9M100	18	\$11
	20	\$11
9M300	18	\$29
	20	\$29

Meridian® Stackable™ Lateral File Accessories

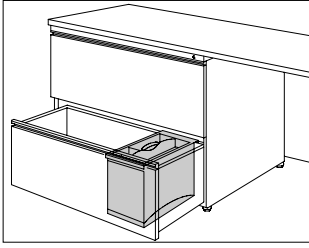

Product Information

Description

This 2-sectioned organizer fits into any file drawer arranged for letter-size filing. The removable top section stores computer disks and other small items. The bottom section stores larger items or can be divided into 3 compartments; it includes 2 vertical dividers. Finish is black umber.

Dimensions

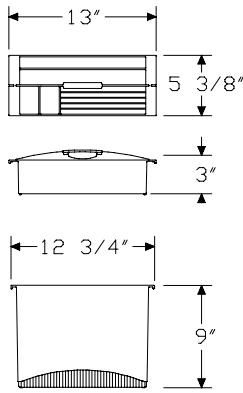

Specification Information

Step 1.

LG901

\$62

EnhancedAccess™ Pull

EAP-L

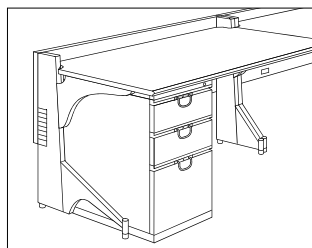

Product Information

Description

This plastic loop-style pull slides into the standard pull or Tu™ W-pull on a pedestal or lateral file drawer. It makes the drawer easier to open. Package contains 1 pull and attachment hardware.

Dimensions

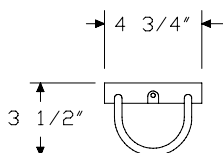

Specification Information

Step 1.

EAP-

Step 2. Pull Style

L loop

Prices for Steps 1-2.

EAP-L \$37

Step 3. Finish

BU	black umber	+\$0
HF	inner tone light	+\$0
MT	medium tone	+\$0

Index by Product Name

Meridian® Lateral Files	
	page(s)
Arc-Pull Freestanding Lateral File	11
Bevel-Pull Freestanding Lateral File	17
Bevel-Pull Mobile Lateral File	50
Contour-Pull Freestanding Lateral File	21
Contour-Pull Mobile Lateral File	54
Ellipse-Pull Freestanding Lateral File	26
EnhancedAccess™ Pull	63
File Drawer Organizer	62
Front-to-Back Filing Rail, Meridian® Stackable™ Lateral File	59
Frontless Freestanding Lateral File	31
Lateral File Retrofit Cushion Top	44
Movable Divider, Meridian®, Quadrant® or Tu™ Lateral File	61
Side-to-Side Filing Rail, Meridian® Stackable™ Lateral File	60
Sloped-Pull Freestanding Lateral File	35
Standard-Pull Freestanding Lateral File	7
Standard-Pull Mobile Lateral File	46
Teneo™-Pull Freestanding Lateral File	41

Index by Product Number

23-30	Frontless Freestanding Lateral File	page(s) 31	M24-3	Bevel-Pull Mobile Lateral File	50
23-36			M24-4		
23-42			M25-3	Contour-Pull Mobile Lateral File	54
24-30	Bevel-Pull Freestanding Lateral File	17	M25-4		
24-36			M26-3	Standard-Pull Mobile Lateral File	46
24-42			M26-4		
25-30	Contour-Pull Freestanding Lateral File	21	TC1-3	Lateral File Retrofit Cushion Top	44
25-36			TC1-4		
25-42			TC2-3		
26-30	Standard-Pull Freestanding Lateral File	7	TC2-4		
26-36					
26-42					
29P-3	Sloped-Pull Freestanding Lateral File	35			
29P-4					
29V-3					
29V-4					
2A-30	Arc-Pull Freestanding Lateral File	11			
2A-36					
2A-42					
2D-30					
2D-36					
2D-42					
2J-30	Ellipse-Pull Freestanding Lateral File	26			
2J-36					
2J-42					
2T-30	Teneo™-Pull Freestanding Lateral File	41			
2T-36					
2T-42					
9M100	Movable Divider, Meridian®, Quadrant® or Tu™ Lateral File	61			
9M300					
9P001	Front-to-Back Filing Rail, Meridian® Stackable™ Lateral File	59			
9P002					
9P361					
9P362					
9R124	Side-to-Side Filing Rail, Meridian® Stackable™ Lateral File	60			
9R130					
9R136					
9R142					
9R224					
9R230					
9R236					
9R242					
EAP-L	EnhancedAccess™ Pull	63			
LG901	File Drawer Organizer	62			

For more information about our products and services or to see a list of dealers, please visit us at www.HermanMiller.com or call (800) 851 1196.

This book is recyclable. Printed in U.S.A. on recycled paper.

© 2009 Herman Miller, Inc., Zeeland, Michigan

© HermanMiller, , Abak, Action Office, Aeron, Ambi, Ardea, Aside, Avive, Babble, C2, Caper, Celle, Co/Struc, DOT, Eames, Embody, Equa 2, Ergon 3, Ethospace, Fine-Tune, FlexFront, Formcoat, Ground Cloth, Herman Miller for Healthcare, Herman Miller Options, Intersect, Kinemat, Leaf, Lifework, Limerick, Meridian, Mirra, Passage, Pedastool, Pellicle, Perspectives, PostureFit, Prospects, Quadrant, Reaction, Resolve, RoomTune, Scooter, Stoa, Teneo, V-Wall, Vary Easy, Vivo, and Z-Axis are among the registered trademarks of Herman Miller, Inc., and its owned subsidiaries.

™ About Face, AireWeave, Airia, Arrio, Backfit, Boomerang, Bubbletack, Burdick Group, Celeste, Cellular Suspension, CLT, CoActive, Cognita, Compass, Cygnus, Enchord, EnhancedAccess, E-Wall, Flex-Edge, Flute, Harmonic, Herman Miller for the Home, Herman Miller International Collection, Herman Miller Select, Hopsak 2, Intent, Iota, Keyless Entry, Latitude, Lyris, Multiscrim, My Studio Environments, Nelson, Pixelated Support, Programmable Environments, Q, Rapunzel, Recline Selector, Sense, Setu, Stackable, Stackable Storage, The Be Collection, Thinking is good for you, TriFlex, Tu, and Twist are among the trademarks of Herman Miller, Inc., and its owned subsidiaries.

SM TAP, Textile Alliance Program and Thoughtpile are among the service marks of Herman Miller, Inc.

Chemsurf is a registered trademark of Wilsonart International.

Corian is a registered trademark of DuPont.

FLEXNET is a trademark of Milliken & Co.

Floor Saver Glide™ is a trademark of Carpin Manufacturing Inc.

Geiger is a registered trademark of Geiger International.

Goetz is a trademark of Mark W. Goetz.

Hang-It-All is a registered trademark of Lucia Eames Demetrios, d.b.a. Eames Office.

Holophane is a registered trademark of Holophane.

Ingeo is a trademark of Cargill Dow LLC.

Microsoft and Natural Keyboard are registered trademarks of Microsoft Corporation.

Noguchi® is a registered trademark of The Isamu Noguchi Foundation and Garden Museum.

Qt Quiet technology and Qt are trademarks of Cambridge Sound Management, Inc.